

GASTRO IMPULS

Hunkeler Gastro AG



Gastrolösungen für überALL

2018

Gastroimpuls seit 1946

Impulsgeber für die Gastronomie

Wer nicht mit der Zeit geht, geht mit der Zeit. Daher suchen wir Tag für Tag nach innovativen Produkten oder entwickeln diese gleich selbst. Sie als Kunde stehen dabei im Mittelpunkt, denn Sie entscheiden ob etwas gut ist oder nicht. Unser vielfältiges Sortiment finden Sie zudem im Webshop abgebildet, sodass Sie rund um die Uhr Ihre Bestellungen platzieren können.

Als langjähriger Kenner der Branche wissen wir, was Ihnen und Ihren Gästen wichtig ist. Besuchen Sie unseren Showroom mit über 550m² und lassen Sie sich kompetent beraten! Voranmeldung erwünscht.

Auswahl

Über 18000
Artikel finden
Sie in unserem
Sortiment.



Mario Hunkeler
CEO



Bruno Hunkeler
VRP



Magdalena Ritz
Mitglied GL



Christian Jaeger
Leiter Einkauf



Stefan Kohler
Einkauf



Iwan von Ah
Verkaufsleiter



Claudia Gildehaus



Janine Fischer



Nadine Birr



Stefania Ruta



Mirjana Lukic



Marianne
Zimmermann



Michael Ritz



Ilaria Serpa



Serge Hauser



Mathias Eilenberger
Aussendienst



Sascha Krummenacher
Aussendienst



Luciano Gaiarin
Aussendienst



Marcel Schneiter
Aussendienst



Luca Goldhorn
Aussendienst

Bestellen Sie schnell und unkompliziert



Per Telefon 041 368 91 91
Per Fax 041 368 91 90

Montag – Freitag: 8.00 – 12.00 / 13.00 – 17.00 Uhr



Per Webshop
7 Tage, 24 Std einkaufen

www.gastroimpuls.ch/shop



Per Internet

info@gastroimpuls.ch
www.gastroimpuls.ch



Per Post

Gastroimpuls
Hunkeler Gastro AG | Grimselweg 5 | 6002 Luzern



Showroom

Öffnungszeiten
Montag – Freitag: 8.00 – 12.00 / 13.00 – 17.00 Uhr
Anmeldung erwünscht



Kreditkarten

Wir akzeptieren alle gängigen Kreditkarten

Zeichenerklärung



Verpackungseinheit



Selbstmontage

Bei Farben entsprechen die letzten zwei Zahlen der Artikelnummer dem Farbcode. Zum Beispiel:

100 40 **15** oder

100 40 **45**

Unsere Vertragspartner

HOREGO AG

AMARENO
SWISS GASTRO SERVICE

MINOTEL
The Swiss Purchasing Group since 1983

PISTOR
Vertragslieferant **plus**

Partner of



BEST 3 STAR HOTELS
of Switzerland

Papierwaren / Take-Away

Servietten
Tischdecken
Tischsets
Untersetzer
Fingerfood
Take-Away

6 – 37

Hygiene / Reinigung

Toilettenartikel
Reinigung
Toilettenpapier
Handtuchpapier
Abfall

38 – 59

Table Top

Porzellan
Glas
Besteck
Kaffee / Tee

60 – 211

Bar

Bargläser / Digestif
Barartikel
Weinkultur

212 – 237

Buffet

Finger Food
Gastronorm / Schalen
Buffet
Wagen

238 – 289

Service

Tischzubehör
Getränke / Menukarten
Werbetafeln
Tablett
Kinder
Personal

290 – 339

Küche

Pfannen / Töpfe
Küchenutensilien
GN-Schalen
Maschinen
Apparate
Hygiene

340 – 409

Systemgastronomie

Transport
Lagerung
Gläserkörbe
Systemporzellan
Speiseverteilung

410 – 429

Hotel

Hoteldkosmetik
Zimmer
Etage
Reception
Garderobe

430 – 444

Inhalt / Adresse

Inhaltsverzeichnis A-Z
Adresse
Ortsplan
Verkaufsbedingungen

445 – 450



Teamchef: Norman Hunziker

Teamcaptain: Steven Duss

Teammitglieder: Manuel Engel, Daniel Straumann, Jean-Michel Wittmer, Normand Jubin, Bettina Marti, Rebecca Relling, Dominik Roider

Gastroimpuls ist stolzer Sponsor und Ausrüster der Schweizer Kochnationalmannschaften, den Aushängeschildern des Schweizer Kochverbandes.



Teamchef: Jordan Thompson

Teamcaptain: Christian Oliveira

Teammitglieder: Stefanie Siegenthaler, Frederick Jud, Jorge Cardoso, Jennifer Kunz, Silvan Holenstein, Niklas Schneider



Gastroimpuls bietet Gastrolösungen für überALL

Papierwaren / Take-Away / Textilien

Airlaid *Mantel*

Coffee-to-Go *premi Star*

Dinnertex® *Soft*

Finesse



**Papierwaren
Textilien**

Servietten
Tischdecken
Untersetzer
Take-Away

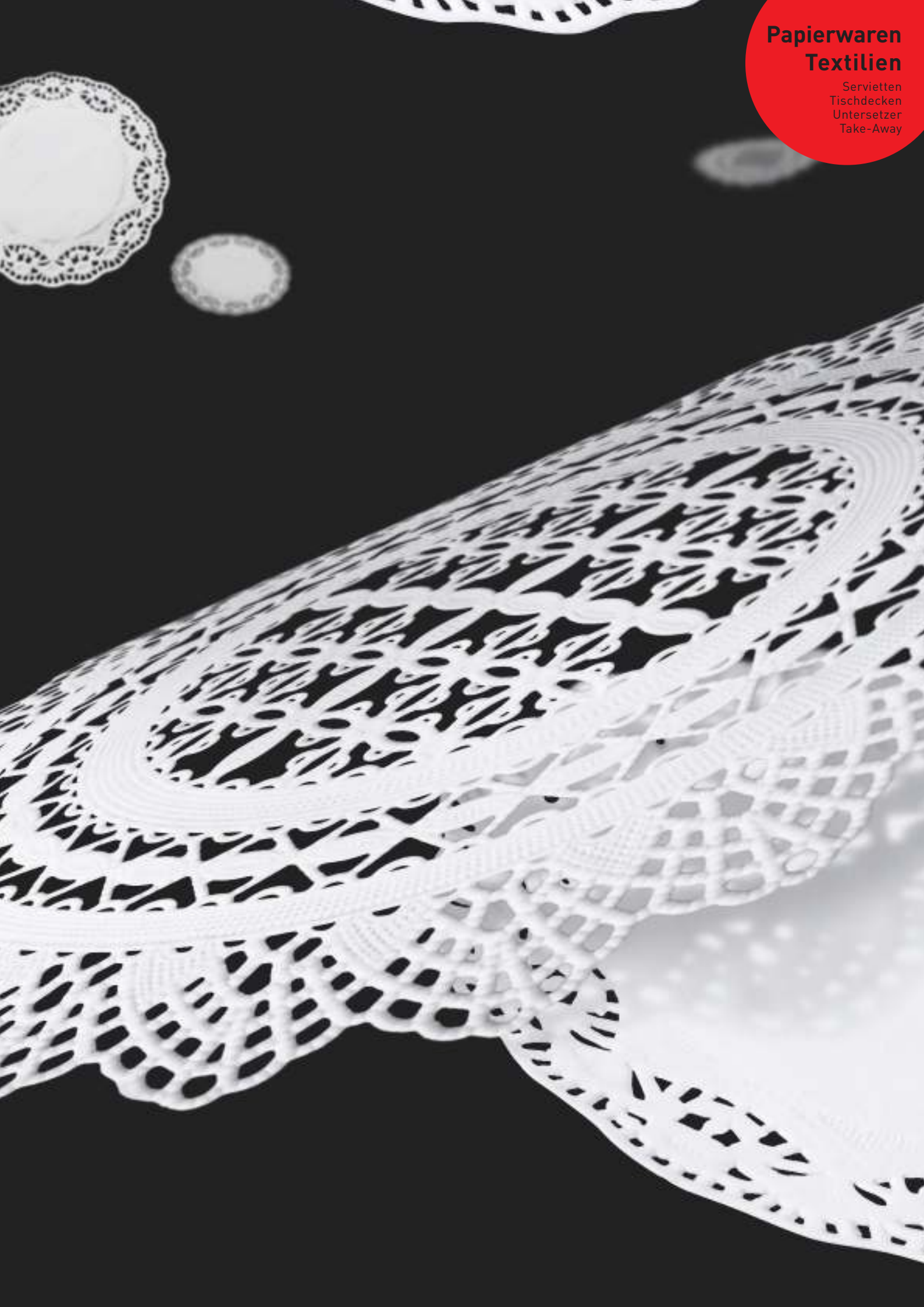



1000 ab
19.50

hulu Brunch/Snack Servietten, 2-lagig

Tissue, 1/8 Falzung, 33 x 33 cm

	Stück	1	24	48
100 00 00 weiss	1 1000	26.00	23.40 10 %	19.50 25 %
	Stück	1	14	28
100 05 02 champagne	1 2400 100 =	79.00 3.29	71.10 2.96	59.25 2.47
100 05 15 gelb	1 2400	79.00	71.10	59.25
100 05 37 fuchsia	1 2400	79.00	71.10	59.25
100 05 45 rot	1 2400	79.00	71.10	59.25
100 05 48 bordeaux	1 2400	79.00	71.10	59.25
100 05 51 kiwi	1 2400	79.00	71.10	59.25
100 05 56 grün	1 2400	79.00	71.10	59.25
100 05 58 tannengrün	1 2400	79.00	71.10	59.25
100 05 65 blau	1 2400	79.00	71.10	59.25
100 05 85 braun	1 2400	79.00	71.10	59.25
100 05 99 schwarz	1 2400	79.00	71.10	59.25



1/8 Falzung, 33 x 33 cm

hulu Lunch Servietten, 2-lagig

Tissue, 1/8 Falzung, 40 x 40 cm

	Stück	1	18	36
100 20 00 weiss	1 1000	35.00	31.50 10 %	26.25 25 %
100 20 02 champagne	1 1000	53.00	47.70	39.75
100 20 15 gelb	1 1000	53.00	47.70	39.75
100 20 37 fuchsia	1 1000	53.00	47.70	39.75
100 20 45 rot	1 1000	53.00	47.70	39.75
100 20 48 bordeaux	1 1000	53.00	47.70	39.75
100 20 51 kiwi	1 1000	53.00	47.70	39.75
100 20 56 grün	1 1000	53.00	47.70	39.75
100 20 58 tannengrün	1 1000	53.00	47.70	39.75
100 20 65 blau	1 1000	53.00	47.70	39.75
100 20 85 braun	1 1000	53.00	47.70	39.75
100 20 99 schwarz	1 1000	53.00	47.70	39.75



1/8 Falzung, 40 x 40 cm



1000 ab
36.50

hulu Dinner Servietten, 3-lagig

Tissue, 1/8 Falzung, 40 x 40 cm

		Stück	1	20	40
				10 %	25 %
100 40 00	weiss	1 1000	48.00	43.20	36.00
100 40 02	champagne	1 1000	77.00	69.30	57.75
100 40 15	gelb	1 1000	77.00	69.30	57.75
100 40 27	terracotta	1 1000	77.00	69.30	57.75
100 40 37	fuchsia	1 1000	77.00	69.30	57.75
100 40 45	rot	1 1000	77.00	69.30	57.75
100 40 48	bordeaux	1 1000	77.00	69.30	57.75
100 40 51	kiwi	1 1000	77.00	69.30	57.75
100 40 56	grün	1 1000	77.00	69.30	57.75
100 40 58	tannengrün	1 1000	77.00	69.30	57.75
100 40 65	blau	1 1000	77.00	69.30	57.75
100 40 85	braun	1 1000	77.00	69.30	57.75
100 40 99	schwarz	1 1000	77.00	69.30	57.75

hulu Dinner Servietten, 3-lagig

Tissue, 1/4-Falzung, 40 x 40 cm

		Stück	1	20	40
				10 %	25 %
100 54 00	weiss	1 1000	48.00	43.20	36.00
100 52 02	champagne	1 1000	77.00	69.30	57.75
100 52 15	gelb	1 1000	77.00	69.30	57.75
100 52 27	terracotta	1 1000	77.00	69.30	57.75
100 52 37	fuchsia	1 1000	77.00	69.30	57.75
100 52 45	rot	1 1000	77.00	69.30	57.75
100 52 48	bordeaux	1 1000	77.00	69.30	57.75
100 52 51	kiwi	1 1000	77.00	69.30	57.75
100 52 56	grün	1 1000	77.00	69.30	57.75
100 52 58	tannengrün	1 1000	77.00	69.30	57.75
100 52 65	blau	1 1000	77.00	69.30	57.75
100 52 85	braun	1 1000	77.00	69.30	57.75
100 52 99	schwarz	1 1000	77.00	69.30	57.75



1/8 Falzung, 40 x 40 cm

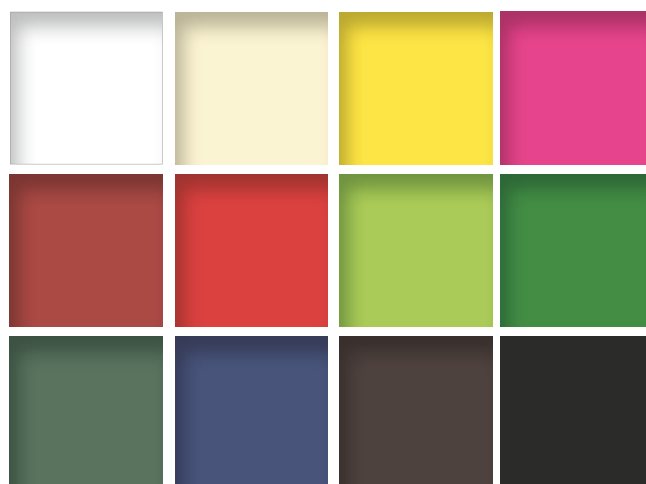

1/4 Falzung, 40 x 40 cm



Servietten Deco Soft uni

Schöne, weiche, stabile tip-to-tip-Serviette. Ideal zum kreativen Aufstellen. Die günstige Alternative zu den Airlaid-Servietten

Tissue, 1/4-Falzung, 40 x 40 cm.

		Stück	1	18	36
				10 %	25 %
101 42 00	weiss	1 600 100 =	57.00 9.50	51.30 8.55	42.75 7.13
101 42 02	crème	1 600 100 =	64.00 10.67	57.60 9.60	48.00 8.00
101 42 48	bordeaux	1 600	64.00	57.60	48.00
101 42 85*	hellbraun	1 600	59.00	53.10	44.25



Servietten Deco Soft Victorian

Schöne, bedruckte, weiche, stabile tip-to-tip-Serviette. Ideal zum kreativen Aufstellen. Die günstige Alternative zu den Airlaid-Servietten

Tissue, 1/4-Falzung, 40 x 40 cm.

		Stück	1	18	36
				10 %	25 %
101 41 00	weiss	1 600 100 =	64.00 10.67	57.60 9.60	48.00 8.00
101 41 02	crème	1 600 100 =	71.00 11.83	63.90 10.65	53.25 8.88
101 41 49	burgund	1 600	71.00	63.90	53.25
101 41 51*	kiwi	1 600	66.00	59.40	49.50

Airlaid Soft-Servietten mit Dekorrand



		Stück	1	15	30
				15 %	25 %
101 05 17	Rand gold	1 800 100 =	159.00 19.88	135.15 16.90	119.25 14.91
101 05 48	Rand bordeaux	1 800	159.00	135.15	119.25
101 05 65	Rand blau	1 800	159.00	135.15	119.25

Airlaid Soft-Servietten marmoriert



		Stück	1	15	30
				25 %	
101 10 10*	gelb	1 800 100 =		133.00	99.75
101 10 55*	grün	1 800		133.00	99.75

Airlaid Soft-Servietten Elite



		Stück	1	15	30
				15 %	25 %
101 15 02*	champagne	1 800 100 =	169.00 21.13	143.65 17.96	126.75 15.85
101 15 45*	rosa	1 800	169.00	143.65	126.75
101 15 65*	blau	1 800	169.00	143.65	126.75

Papierwaren / Take-Away



hulu Airlaid Servietten uni

Überzeugen Sie Ihre Gäste mit einem Ambiente, das zum Stil Ihres Hauses passt. Airlaid Servietten sind im Griff und der Optik von richtigen Stoffservietten kaum zu unterscheiden. Sie lassen sich perfekt falten und aufstellen. 1/4-Falzung, 40 x 40 cm

		Stück	1	16	32
				15 %	25 %
101 02 00	weiss	1 600	96.80	82.28	72.60
		100 =	16.13	13.71	12.10
101 00 02	champagne	1 800	199.00	169.15	149.25
		100 =	24.88	21.15	18.66
101 00 03	elfenbein	1 800	199.00	169.15	149.25
101 00 15	gelb	1 800	199.00	169.15	149.25
101 00 21	lachs	1 800	199.00	169.15	149.25
101 00 27	terracotta	1 800	199.00	169.15	149.25
101 00 45	rot	1 800	199.00	169.15	149.25
101 00 48	bordeaux	1 800	199.00	169.15	149.25
101 00 55	dunkelgrün	1 800	199.00	169.15	149.25
101 00 51	kiwi	1 800	199.00	169.15	149.25
101 00 60	hellblau	1 800	199.00	169.15	149.25
101 00 65	dunkelblau	1 800	199.00	169.15	149.25
101 00 85	dunkelbraun	1 800	199.00	169.15	149.25
101 00 99	schwarz	1 800	199.00	169.15	149.25



Airlaid Servietten Victoria

Neue weiche Qualität, 1/4-Falzung, 40 x 40 cm

		Stück	1	10	20
				15 %	25 %
101 17 00	weiss	1 600	135.00	114.75	101.25
		100 =	22.50	19.13	16.88
101 18 02	champagner	1 600	135.00	114.75	101.25
101 17 19	ocker	1 600	135.00	114.75	101.25
101 17 82	sand	1 600	135.00	114.75	101.25
101 17 95	grau	1 600	135.00	114.75	101.25
101 16 51*	kiwi	1 800	179.00	152.15	134.25



100 ab
1.80



hulu Apéro-Servietten, 2-lagig

Tissue, 1/4 Falzung, kleine Serviette für Pâtisseries, Apéros, Parties etc.

		Stück	1	26	52
100 61 01	weiss, 24 x 24 cm	1	1500 100 =	39.00	29.25
				2.60	2.34
100 63 99	schwarz, 25 x 25 cm	1	3000 100 =	84.00	63.00
				2.80	2.52

Apéro-Cocktail Servietten, 2-lagig

Tissue, 1/4 Falzung, 24 x 24 cm



		Stück	1		1
100 64 00	weiss	1	2400 100 =	72.00	57.60
					2.40

Servietten-Halter quadratisch

für Cocktailservietten 24 x 24 cm bis 25 x 25 cm

Aus verchromtem 5 mm starkem Draht, hochglänzend



		Stück	1		1
101 30 07	Für Servietten bis 25x25, 1/4, 140 x 140 mm, H: 200 mm	1	1		14.80

hulu Pic, 1-lagig

Tissue, Servietten für Frühstück und Kleinigkeiten, 33 x 33 cm



		Stück	1	8	15
100 71 00	1/8 Falzung	1	4000 100 =	76.00	57.00
				1.90	1.71

Serviettenspender CNS 18/0



		Stück	1		1
100 83 00	Spender, 10 x 12 cm, H: 19 cm	1	1	19.80	15.84
100 70 00	Servietten Nova, 32 x 30 cm	1	6000 100 =	99.80	74.85
				1.66	1.49

hulu Servietten-Halter

Eisendraht, verchromt



		Stück	1		1
101 30 03	Für Servietten bis 33 x 33cm, 1/8, 190 x 100 mm, H: 210 mm	1	1		18.80
101 30 04	Für Servietten bis 41 x 41cm, 1/8, 242 x 108 mm, H: 188 mm	1	1		19.80
101 30 05	Für Servietten bis 41 x 41cm, 1/4, Halter quadratisch, 215 x 215 mm, H: 188 mm	1	1		19.80
101 30 06*	Für Servietten bis 33 x 33cm, 1/4, Halter dreieckig, 275 x 155 mm, H: 235 mm	1	1		19.80

Papierwaren / Take-Away



Besteck-Serviettentaschen Basic

Tissue, 4-lagig geprägt, Falzung 1/8, 40 x 40 cm mit Schlitz für Besteck

		Stück	1	15	30
				10 %	20 %
101 24 00	weiss	1 600	89,00	80,10	71,20
		100 =	14,83	13,35	11,86
101 24 02	champagne	1 600	99,00	89,10	79,20
		100 =	16,50	14,85	13,20
101 24 15	gelb	1 600	99,00	89,10	79,20
101 24 27	terracotta	1 600	99,00	89,10	79,20
101 24 45	rot	1 600	99,00	89,10	79,20
101 24 48	bordeaux	1 600	99,00	89,10	79,20
101 24 55	grün	1 600	99,00	89,10	79,20
101 24 65	blau	1 600	99,00	89,10	79,20
101 24 76	aubergine	1 600	99,00	89,10	79,20
101 24 99	schwarz	1 600	99,00	89,10	79,20



Besteck-Serviettentaschen Airlaid

Vollwertige, grossformatige Airlaidserviette. Der patentierte Schlitz für Besteck macht aus der Serviette gleichzeitig eine Bestecktasche. Ermöglicht sehr schnelles Aufdecken, ideal für Garten oder Terrasse. Dank des Bestecks bleiben die Servietten windsicher am Platz, 1/8 Falzung, 40 x 40 cm.

		Stück	1	15	30
				10 %	20 %
101 22 00	weiss	1 600	107,00	96,30	85,60
		100 =	17,83	16,05	14,26
101 22 01	champagne	1 600	150,00	135,00	120,00
		100 =	25,00	22,50	20,00
101 22 15	gelb	1 600	150,00	135,00	120,00
101 22 27	terracotta	1 600	150,00	135,00	120,00
101 22 45	rot	1 600	150,00	135,00	120,00
101 22 48	bordeaux	1 600	150,00	135,00	120,00
101 22 51	kiwi	1 600	150,00	135,00	120,00
101 22 55	grün	1 600	150,00	135,00	120,00
101 22 76	aubergine	1 600	150,00	135,00	120,00
101 22 99	schwarz	1 600	150,00	135,00	120,00



Bestecktasche mit Serviette "Bon Appétit"

Bestecktasche braun, Aufdruck "Bestecke" und "Bon Appétit" auf Lasche, Serviette Tissue, 1/8-Falzung, 40 x 40 cm weiss.

Individuell für Sie bedruckte Bestecktaschen sind bereits ab 12'000 Stück möglich

		Stück	1	12	30
				10 %	20 %
101 50 01	braun	1 500	124,00	111,60	99,20
		1 =	0,25	0,23	0,20



Ihre persönlichen Servietten!

In verschiedenen Grössen und Qualitäten
erhältlich

25x25, 33x33 oder 40x40

25x25



40x40

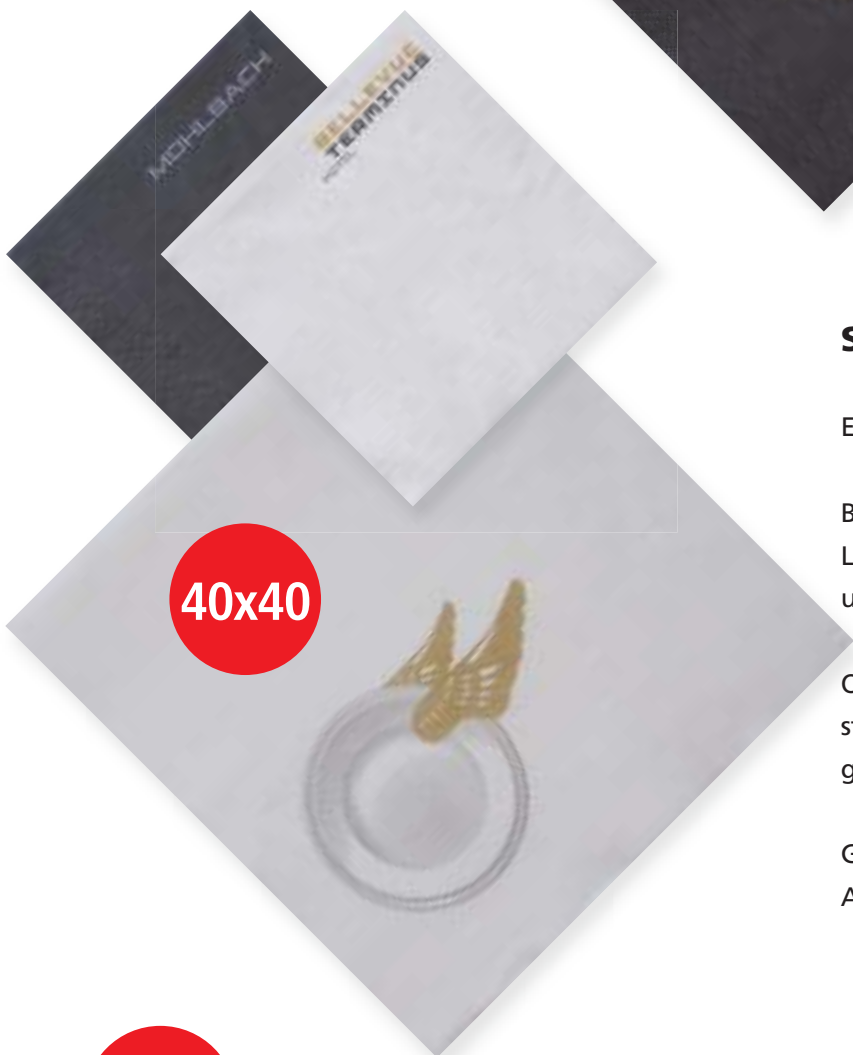

Servietten mit Ihrem Logo?

Einfacher und günstiger als Sie denken.

Bedruckte Servietten mit Ihrem persönlichen Logo etc. sind in verschiedenen Grössen, Farben und Qualitäten möglich!

Ob für den Apéro, Apéro-Riche oder den stilvollen Abend - wir liefern Ihnen die gewünschten Servietten zu Top-Preisen.

Gerne unterbreiten wir Ihnen ein passendes Angebot - kontaktieren Sie uns.

33x33



100 ab
24.66

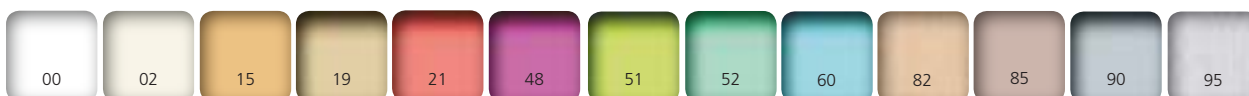

Servietten Deluxe

Die hochwertigen Einweg-Servietten mit stoff-ähnlicher Struktur und Haptik, werden höchsten Ansprüchen gerecht!

Von Stoffservietten kaum zu unterscheiden - in Optik und Haptik!

Ideal zum Falten, sehr saugfähig und reissfest

Cocktail Servietten Deluxe

beidseitig bedruckt, 1/4 Falzung, 25 x 25 cm

25x25

		Stück	1	20	40
				10 %	20 %
101 80 00	polarweiss	1 1000	198.00	178.20	158.40
		100 =	19.80	17.82	15.84
101 80 85	cacao	1 1000	198.00	178.20	158.40
101 80 90	silbergrau	1 1000	198.00	178.20	158.40
101 80 95	dunkelgrau	1 1000	198.00	178.20	158.40

Servietten Deluxe

beidseitig bedruckt, 1/4 Falzung, 40 x 40 cm

40x40

		Stück	1	20	40
				10 %	20 %
101 81 00	polarweiss	1 600	185.00	166.50	148.00
		100 =	30.83	27.75	24.66
101 81 02	champagne	1 600	185.00	166.50	148.00
101 81 15	gelb	1 600	185.00	166.50	148.00
101 81 19	ocker	1 600	185.00	166.50	148.00
101 81 21*	lachs	1 600	185.00	166.50	148.00
101 81 48	bordeaux	1 600	185.00	166.50	148.00
101 81 51	kiwi	1 600	185.00	166.50	148.00
101 81 52*	smaragd	1 600	185.00	166.50	148.00
101 81 60	blau	1 600	185.00	166.50	148.00
101 81 82	taupe	1 600	185.00	166.50	148.00
101 81 85	cacao	1 600	185.00	166.50	148.00
101 81 90	silbergrau	1 600	185.00	166.50	148.00
101 81 95	dunkelgrau	1 600	185.00	166.50	148.00



40x40

Servietten Flower

beidseitig bedruckt, 1/4 Falzung, 40 x 40 cm

		Stück	1	20	40
				10 %	20 %
101 82 19	ocker	1 600	185.00	166.50	148.00
		100 =	30.83	27.75	24.66
101 82 48	bordeaux	1 600	185.00	166.50	148.00
101 82 55	grün	1 600	185.00	166.50	148.00
101 82 60	blau	1 600	185.00	166.50	148.00
101 82 95	grau	1 600	185.00	166.50	148.00



30x40

Servietten Kitchen

30 x 40 cm

		Stück	1	20	40
				10 %	20 %
101 83 15	gelb	1 600	185.00	166.50	148.00
		100 =	30.83	27.75	24.66
101 83 45	rot	1 600	185.00	166.50	148.00
101 83 55	grün	1 600	185.00	166.50	148.00
101 83 65	blau	1 600	185.00	166.50	148.00
101 83 85	braun	1 500	154.00	138.60	123.20

Dinnertex®

100 ab
21.07

Servietten Dinnertex

Die Dinnertex Servietten sind eine hervorragende Alternative zu Stoffservietten!

Die feinen und exklusiven Vliesstoff-Servietten sehen echten Stoffservietten zum Verwechseln ähnlich und verleihen Ihrem Tisch einen edlen Touch.

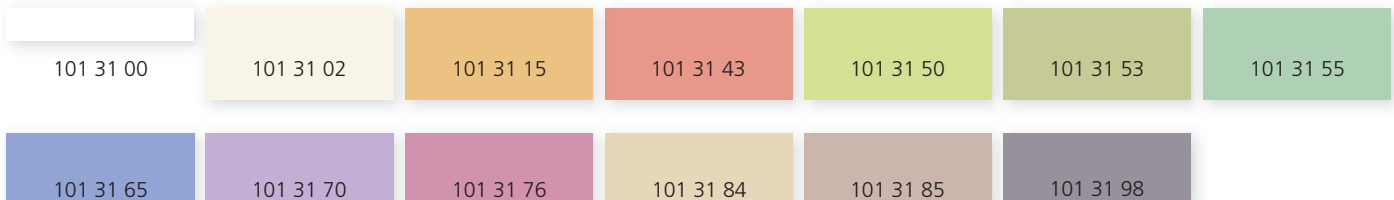

40x40

Dinnertex Servietten Uni

1/4-Falzung, 40 x 40 cm

		Stück	1	20	40
				10 %	20 %
101 31 00	weiss	1 600 100 =	158.00 26.33	142.20 23.70	126.40 21.07
101 31 02	champagne	1 600 100 =	185.00 30.83	166.50 27.75	148.00 24.67
101 31 15	gelb	1 600	185.00	166.50	148.00
101 31 43	granatrot	1 600	185.00	166.50	148.00
101 31 50	pistache	1 600	185.00	166.50	148.00
101 31 53	olive	1 600	185.00	166.50	148.00
101 31 55	grün	1 600	185.00	166.50	148.00
101 31 65	blau	1 600	185.00	166.50	148.00
101 31 70	lila	1 600	185.00	166.50	148.00
101 31 76	aubergine	1 600	185.00	166.50	148.00
101 31 84	hellbraun	1 600	185.00	166.50	148.00
101 31 85	braun	1 600	185.00	166.50	148.00
101 31 98	anthrazit	1 600	185.00	166.50	148.00

46x46

Dinnertex Servietten Uni DELUXE

Extra gross - für den gepflegten Service!

1/4-Falzung, 46 x 46 cm

		Stück	1	20	40
				10 %	20 %
101 63 01	aqua (weisslich)	1 480 100 =	225.00 46.88	202.50 42.19	180.00 37.50
101 63 02	champagne	1 480	225.00	202.50	180.00
101 63 82	sand	1 480	225.00	202.50	180.00
101 63 85	braun	1 480	225.00	202.50	180.00
101 63 95	grau	1 480	225.00	202.50	180.00
101 63 98	anthrazit	1 480	225.00	202.50	180.00

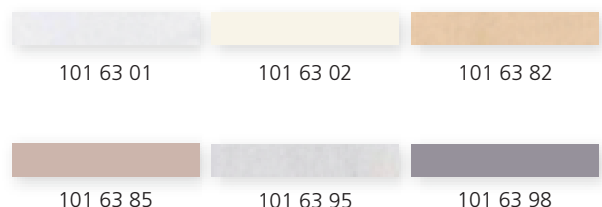

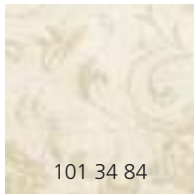

101 34 84

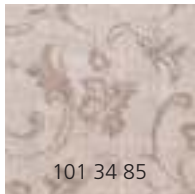

101 34 85

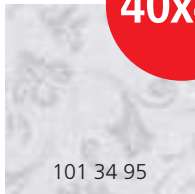

101 34 95

40x40

Dinnertex Servietten Jaquard 40 x 40

1/4-Falzung, 40 x 40 cm

	Stück	1	20	40
			10 %	20 %
101 34 84 hellbraun	1 600 100 =	189.00 31.50	170.10 28.35	151.20 25.20
101 34 85 braun	1 600	189.00	170.10	151.20
101 34 95 grau	1 600	189.00	170.10	151.20

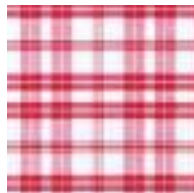

101 37 45

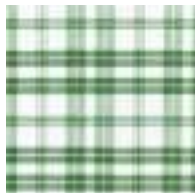

101 37 55



101 37 65

Dinnertex Servietten Karo

1/4-Falzung, 40 x 40 cm

	Stück	1	20	40
			10 %	20 %
101 37 45 rot	1 600 100 =	189.00 31.50	170.10 28.35	151.20 25.20
101 37 55 grün	1 600	189.00	170.10	151.20
101 37 65 blau	1 600	189.00	170.10	151.20

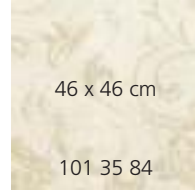

46 x 46 cm

101 35 84

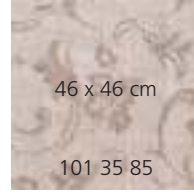

46 x 46 cm

101 35 85

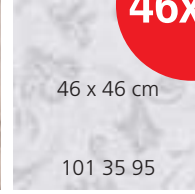

46 x 46 cm

101 35 95

46x46

Dinnertex Servietten Jaquard DELUXE

1/4-Falzung, 46 x 46 cm

	Stück	1	20	40
			10 %	20 %
101 35 84 hellbraun	1 480 100 =	225.00 46.88	202.50 42.19	180.00 37.50
101 35 85 braun	1 480	225.00	202.50	180.00
101 35 95 grau	1 480	225.00	202.50	180.00



101 60 02

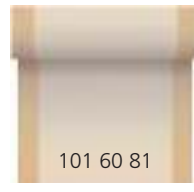

101 60 81

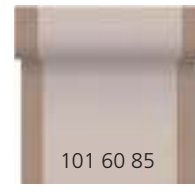

101 60 85



101 60 91

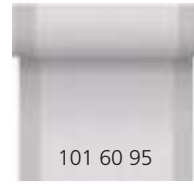

101 60 95

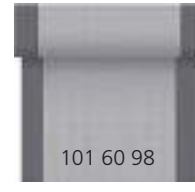

101 60 98

Dinnertex Tischläufer

48 x 120 cm, 20 Tischläufer auf einer Rolle

	Stück	1	8	16
			10 %	20 %
101 60 02 elfenbein	1 8 1 =	235.00 29.38	211.50 26.44	188.00 23.50
101 60 81 hellbeige	1 8	235.00	211.50	188.00
101 60 85 braun	1 8	235.00	211.50	188.00
101 60 91 hellgrau	1 8	235.00	211.50	188.00
101 60 95 grau	1 8	235.00	211.50	188.00
101 60 98 anthrazit	1 8	235.00	211.50	188.00



Servietten-
ringe
Seite 29

1000 ab
26.18



hulu Tischsets Bistro gerade / gezackt

Stabiles Papier geprägt, 70 g/m²
weiss

	Stück	1	6	12
102 30 00 gezackter Rand, 29x39 cm	1 1000 =	2500 45.40	113.50 40.86	102.15 38.59
102 03 00 gerader Rand, 30x40 cm	1 1000 =	2500 30.80	77.00 27.72	69.30 26.18



hulu Tischsets uni satiniert

Papier geprägt, 30 x 40 cm, 60 g/m²

	Stück	1	6	12
102 03 00 weiss	1 1000 =	2500 30.80	77.00 27.72	69.30 26.18
102 02 02 champagne	1 1000 =	2000 49.50	99.00 44.55	89.10 42.08
102 02 15 gelb	1	2000	99.00	89.10
102 02 48 bordeaux	1	2000	99.00	89.10
102 02 45 rot	1	2000	99.00	89.10
102 02 52 kiwi	1	2000	99.00	89.10
102 02 54 pastel	1	2000	99.00	89.10
102 02 58 tannengrün	1	2000	99.00	89.10
102 02 65 blau	1	2000	99.00	89.10
102 02 89 dunkelbraun	1	2000	99.00	89.10
102 02 99 schwarz	1	2000	99.00	89.10

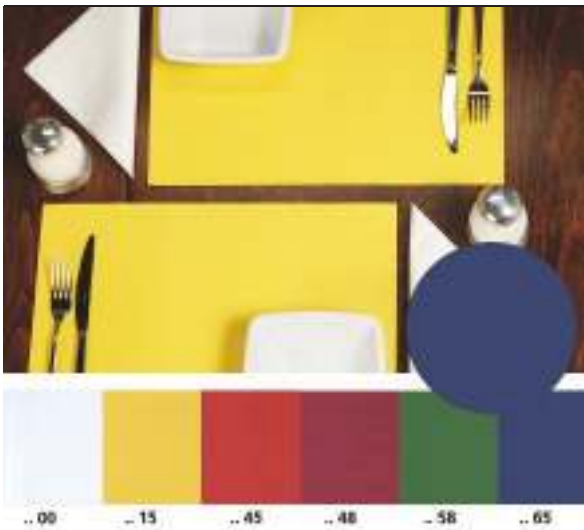

Tischsets

Papier geprägt, 30 x 40 cm, seiden-matt

	Stück	1	6	12
102 03 00 weiss	1 1000 =	2500 30.80	77.00 27.72	69.30 26.18
102 23 15 gelb	1 1000 =	2500 59.60	149.00 53.64	134.10 47.68
102 23 45 rot	1	2500	149.00	134.10
102 23 48 bordeaux	1	2500	149.00	134.10
102 23 58 tannengrün	1	2500	149.00	134.10
102 23 65 blau	1	2500	149.00	134.10



hulu Tischsets Soft Airlaid

30 x 40 cm, 60/gm²

	Stück	1	6	12
102 26 00 weiss	1	1000	180.00	162.00
102 26 02 champagne	1	1000	210.00	189.00
102 26 15 gelb	1	1000	210.00	189.00
102 26 45 rot	1	1000	210.00	189.00
102 26 48 bordeaux	1	1000	210.00	189.00
102 26 58 tannengrün	1	1000	210.00	189.00
102 26 65 dunkelblau	1	1000	210.00	189.00
102 26 99 schwarz	1	1000	210.00	189.00

Papierwaren / Take-Away

Tischsets Rustico Stroh

Das Recycling-Papier "Rustico stroh" sorgt für einen rustikalen Charme

33 x 40 cm

		Stück		1	6	12
					10 %	20 %
102 12 00	33 x 40 cm	1	600 100 =	29.00 4.83	26.10 4.35	23.20 3.86



Tischsets Rustico bronze

Trendiges Tischset in Packpapier-Optik sorgt für einen Vintage Style, Recycling-Papier

33 x 40 cm

		Stück		1	6	12
					10 %	20 %
102 11 00	33 x 40 cm	1	750 100 =	54.00 7.20	48.60 6.48	43.20 5.76



Tischset Korkoptik

Tischset zweiseitig verwendbar, Vor- und Rückseite in verschiedenen Farben, aus hochwertigem Kunstleder, wasserabweisend, einfaches Abwischen mit feuchten Tuch, 33 x 43 cm

		Stück		1	20 %
122 88 53	kork/offwhite	1	1	20.00	16.00



Tischset Korkoptik

Tischset zweiseitig verwendbar, Vor- und Rückseite in verschiedenen Farben, aus hochwertigem Kunstleder, wasserabweisend, einfaches Abwischen mit feuchten Tuch, 33 x 43 cm

		Stück		1	20 %
122 88 27	kork/terracotta	1	1	20.00	16.00



Tischset Patchwork

Tischset aus hochwertigem Kunstleder, wasserabweisend, einfaches Abwischen mit feuchten Tuch oder waschbar bis 40°, 33 x 43 cm

		Stück		1	20 %
122 89 00	Felloptik	1	1	17.00	13.60



Weitere Tischsets aus Textil und PVC ab Seite 26



hulu Papier-Tischdecken Bistro

Neue, starke Qualität - weiss geprägt 70 g/m²

		Stück	1	6	12
				10 %	25 %
103 21 10	50 x 70 cm	1 600	119.00	107.10	89.25
		100 =	19.83	17.85	14.88
103 21 20	60 x 60 cm	1 600	119.00	107.10	89.25
103 21 30	60 x 70 cm	1 600	125.00	112.50	93.75
		100 =	20.83	18.75	15.63
103 21 40	60 x 80 cm	1 600	135.00	121.50	101.25
		100 =	22.50	20.25	16.88
103 21 50	60 x 110 cm	1 600	182.00	163.80	136.50
		100 =	30.33	27.30	22.75
103 21 60	70 x 70 cm	1 600	139.00	125.10	104.25
		100 =	23.17	20.85	17.38
103 21 70	70 x 100 cm	1 600	182.00	163.80	136.50
		100 =	30.33	27.30	22.75
103 21 80	70 x 120 cm	1 600	215.00	193.50	161.25
		100 =	35.83	32.25	26.88
103 21 90	80 x 80 cm	1 600	169.00	152.10	126.75
		100 =	28.17	25.35	21.13
103 22 00	80 x 120 cm	1 600	212.00	190.80	159.00
		100 =	35.33	31.80	26.50



Tischdecken Swan-Silk

Wasserdicht, abwaschbar, mehrfach verwendbar, 90 x 90 cm

		Stück	1	6	12
				10 %	25 %
103 50 00	weiss	1 100	132.00	118.80	99.00
103 50 02	champagne	1 100	132.00	118.80	99.00
103 50 45	rot	1 100	169.00	152.10	126.75
103 50 48	bordeaux	1 100	169.00	152.10	126.75
103 50 55	grün	1 100	169.00	152.10	126.75
103 50 60	hellblau	1 100	132.00	118.80	99.00
103 50 68	dunkelblau	1 100	169.00	152.10	126.75



hulu Soft-Napperons

Airlaid, speziell weiche Qualität, saugfähig, 100 x 100 cm

		Stück	1	6	12
				10 %	25 %
103 70 00	weiss	1 100	99.00	89.10	74.25
103 70 02	champagne	1 100	169.00	152.10	126.75
103 70 45	rot	1 100	169.00	152.10	126.75
103 70 48	bordeaux	1 100	169.00	152.10	126.75
103 70 59	dunkelgrün	1 100	169.00	152.10	126.75
103 70 68	dunkelblau	1 100	169.00	152.10	126.75

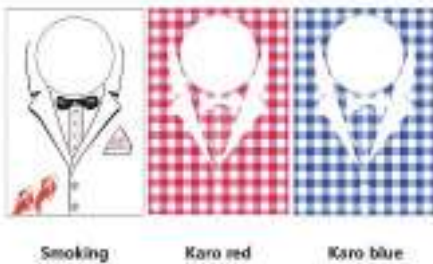

Ess-Latz

Vlies, 42 x 60 cm

		Stück	1
			10 %
101 51 00	Smoking	1 200	76.50
		100 =	38.25
101 51 02	Swiss Karo red	1 200	76.50
101 51 03	Swiss Karo blue	1 200	76.50

Papierwaren / Take-Away

hulu Soft Tischläufer

Tischläufer Airlaid 60 g/m² als farblicher Blickfang
40 cm x 24 Meter, jeweils nach 120 cm perforiert

		Stück	1	4	8
				10 %	20 %
101 25 00	weiss	1	4	63.00	56.70
		1 =	15.75	14.18	12.60
101 25 02	champagne	1	4	89.00	80.10
		1 =	22.25	20.03	17.80
101 25 27	terracotta	1	4	89.00	80.10
101 25 45	rot	1	4	89.00	80.10
101 25 48	bordeaux	1	4	89.00	80.10
101 25 55	dunkelgrün	1	4	89.00	80.10
101 25 65	dunkelblau	1	4	89.00	80.10



hulu Tischdeckrollen Papier Bistro

100 cm breit, Rolle à 50 m, geprägt, weiss 50 g/m²

		Stück	1	7	14
				10 %	20 %
104 00 00	weiss	1	6	129.00	116.10
		1 =	21.50	19.35	17.20
104 00 50	Einzelrolle, weiss	1	1		23.80



Tischdeckrollen hulu Soft Airlaid

120 cm breit, Rolle à 50 m, speziell weiche Qualität

		Stück	1	6	12
				10 %	20 %
104 10 00	weiss	1	1	64.00	57.60
104 10 02	champagne	1	1	98.00	88.20
104 10 45	rot	1	1	98.00	88.20
104 10 48	bordeaux	1	1	98.00	88.20
104 10 59	dunkelgrün	1	1	98.00	88.20
104 10 68	dunkelblau	1	1	98.00	88.20



Tischdeckrollen hulu Vlies

Vliesstoff, 120 cm breit, Rolle à 50 m

		Stück	1	6	12
				5 %	10 %
104 30 00	weiss	1	1	79.00	75.05
104 30 15	gelb	1	1	88.00	83.60
104 30 38	altrosa	1	1	88.00	83.60
104 30 45	rot	1	1	88.00	83.60
104 30 48	bordeaux	1	1	88.00	83.60
104 30 59	dunkelgrün	1	1	88.00	83.60
104 30 68	dunkelblau	1	1	88.00	83.60



Tischdeckrollen Silk

120 cm breit, Rolle à 40 m, wasserdicht, abwischbar, reissfest, mehrfach verwendbar

		Stück	1	6	12
				10 %	20 %
104 20 00	weiss	1	1	85.00	76.50
104 20 02	champagne	1	1	89.00	80.10
104 20 45	rot	1	1	89.00	80.10
104 20 48	bordeaux	1	1	89.00	80.10
104 20 55	grün	1	1	89.00	80.10
104 20 68	dunkelblau	1	1	89.00	80.10



Batterie-Schere

Für den problemlosen glatten Schnitt von Tischrollen

		Stück	1
			50 %
104 90 00		1	24.80 12.40



1000 ab
5.63



hulu Tellerservietten

Geprägt, gezackt 21 g/m²

		Stück	1	16	32
105 00 00	weiss, 17 x 17 cm	1 2000 1000 =	15.00 7.50	13.50 6.75	25.00 11.25



hulu Tellerpapiere weiss

Geprägt, gezackt, 50 g/m²

		Stück	1	12	36
105 12 00	weiss, 12 x 12 cm	1 1000	6.20	43.80	11.04
105 14 00	weiss, 14 x 14 cm	1 1000	6.60	45.80	12.64
105 16 00	weiss, 16 x 16 cm	1 1000	6.90	47.90	14.32



hulu Tassen-Unterlagen weiss

		Stück	1	12	36
105 55 80*	Waffelprägung, 80 mm Ø	1 1000	6.20	5.58 10 %	4.96 20 %
105 55 88*	Waffelprägung, 90 mm Ø	1 1000	6.60	5.94	5.28
105 55 95	Waffelprägung, 95 mm Ø	1 1000	6.90	6.21	5.52



Tissue-Glas-, Tassen und Telleruntersetzer weiss

7-lagig

		Stück	1	12	36
105 87 95	95 mm Ø	1 1000	40.00	36.00 10 %	32.00
105 86 15	150 mm Ø	1 500	53.00	47.70	42.40



hulu Halter

Eisendraht, verchromt

		Stück	1	12	36
101 30 01	10 x 10, H: 18 cm	1 1	18.00		
101 30 02*	17.5 x 17.5 cm, H: 20.5 cm	1 1	19.00		



Velvet Touch antirutsch

Praktische Anti-Rutsch Unterlagen, Farbe schiefermatt

		Stück	1	6	12
105 90 10	11.5 x 11.5 cm für 134 96 14	1 500	29.50	26.55 10 %	23.60 20 %
105 90 11	26 x 11.5 cm für 134 95 28	1 500	60.00	54.00	48.00
105 90 12	27 x 7.5 cm für 134 70 30	1 500	34.50	31.05	27.60
105 90 13	27.5 x 17.5 cm für 135 73 33	1 500	94.00	84.60	75.20
105 90 00	35.5 x 31.5 cm für Dinetray 2821442	1 500 1 =	180.00 0.36	162.00 0.32	144.00 0.29
105 90 01	46.2 x 31.5 cm für Dinetray 2821453	1 500 1 =	219.00 0.44	197.10 0.40	175.20 0.35

Papierwaren / Take-Away



Werbe-Tissue-Unterlagen weiss

Mit Ihrem persönlichen 1- oder 2-Farben-Druck, 5-lagig

		Stück	10	50
105 83 01	1-farbig, 90 mm Ø	1 2000	96.00	76.80
			<small>48.00</small>	<small>38.40</small>
105 83 02	2-farbig, 90 mm Ø	1 2000	104.00	83.20
			<small>52.00</small>	<small>41.60</small>
		Stück	10	50
105 84 01	1-farbig, 100 mm Ø	1 1000	53.00	42.40
105 84 02	2-farbig, 100 mm Ø	1 1000	59.00	47.20
		Stück	10	50
105 85 01	1-farbig, 85 x 85 mm	1 2000	96.00	76.80
			<small>48.00</small>	<small>38.40</small>
105 85 02	2-farbig, 85 x 85 mm	1 2000	104.00	83.20
			<small>52.00</small>	<small>41.60</small>
		Stück	1	1
105 80 51	Pauschalzuschlag Druckzylinder 1-farbig	1 1		130.00
105 80 52	Pauschalzuschlag Druckzylinder 2-farbig	1 1		259.00

Mindestmenge 20'000 Stück



1000 ab
12.64



hulu Plattenpapiere rund, weiss

		Stück	1	12 10 %	30 20 %
106 60 12	12 cm Ø	1 1000	15.80	14.22	12.64
106 60 15	15 cm Ø	1 1000	16.80	15.12	13.44
106 60 17	17 cm Ø	1 1000	21.00	18.90	16.80
106 60 19	19 cm Ø	1 1000	24.00	21.60	19.20
106 61 21	21 cm Ø	1 500	13.90	12.51	11.12
		100 =	2.78	2.50	2.22
106 61 23	23 cm Ø	1 500	15.90	14.31	12.72
		100 =	3.18	2.86	2.54
106 61 25	25 cm Ø	1 500	17.90	16.11	14.32
		100 =	3.58	3.22	2.86
106 61 28	28 cm Ø	1 500	19.80	17.82	15.84
		100 =	3.96	3.56	3.17
106 61 30	30 cm Ø	1 500	24.00	21.60	19.20
		100 =	4.80	4.32	3.84

hulu Plattenpapiere oval, weiss



		Stück	1	12 10 %	30 20 %
106 70 22	22 x 14 cm	1 500	10.80	9.72	8.64
		100 =	2.16	1.94	1.73
106 70 24	24 x 15.5 cm	1 500	11.90	10.71	9.52
		100 =	2.38	2.14	1.90
106 70 27	27 x 16.5 cm	1 500	12.90	11.61	10.32
		100 =	2.58	2.32	2.06
106 70 32	32 x 20 cm	1 500	14.90	13.41	11.92
		100 =	2.98	2.68	2.38
106 70 34	34 x 21 cm	1 500	18.90	17.01	15.12
		100 =	3.78	3.40	3.02
106 70 36	36 x 23 cm	1 500	19.80	17.82	15.84
		100 =	3.96	3.56	3.17
106 70 39	39 x 25 cm	1 500	24.00	21.60	19.20
		100 =	4.80	4.32	3.84
106 70 41	41 x 26 cm	1 500	26.00	23.40	20.80
		100 =	5.20	4.68	4.16
106 70 43	43 x 29 cm	1 500	29.80	26.82	23.84
		100 =	5.96	5.36	4.77
106 70 46	46 x 30 cm	1 500	32.00	28.80	25.60
		100 =	6.40	5.76	5.12
106 70 50	50 x 32 cm	1 500	34.00	30.60	27.20
		100 =	6.80	6.12	5.44



hulu Tablettpapiere

Weiss, geprägt, Rand glatt, 50 g/m2

		Stück	1	12 10 %	30 20 %
106 79 01	cm2 x Preis =, bis 700 cm2	1 500	0.068	0.061	0.054
106 79 02	cm2 x Preis =, ab 701 cm2	1 500	0.062	0.056	0.050
106 79 03	cm2 x Preis =, ab 2001 cm2	1 500	0.058	0.052	0.046
106 79 04	cm2 x Preis, ab 3001 cm2 =	1 500	0.052	0.047	0.042



Tablett-Spitzenpapier, weiss

		Stück	1	12 10 %	30 20 %
106 41 41	41 x 30 cm	1 2000	174.00	156.60	139.20
		1000 =	87.00	78.30	69.60
106 42 46	46 x 36 cm	1 1000	119.00	107.10	95.20
106 50 41	41 x 30 cm	1 250			20.80
		100 =			8.32
106 50 46	46 x 36 cm	1 250			28.70
		100 =			11.48



Kannen-Handschutz

Zellstoffwatte 9-lagig, weiss

		Stück	1	12 15 %
260 14 00	5 x 8 cm	1 500	85.00	72.25
		100 =	17.00	14.45

Papierwaren / Take-Away

Spitzenpapiere Spitz-Zackung, weiss



		Stück	1	6	12
				10 %	20 %
106 35 16	16 cm Ø	1 500	27.00	24.30	21.60
		100 =	5.40	4.86	4.32
106 35 18	18 cm Ø	1 500	31.00	27.90	24.80
		100 =	6.20	5.58	4.96

Spitzenpapiere Rosenmuster, weiss

In verschiedenen Verpackungseinheiten (ab 250 Stück) lieferbar

Fettdicht

1000 ab
11.84



		Stück	1	12	30
				10 %	20 %
106 00 09	9 cm Ø	1 5000	74.00	66.60	59.20
		1000 =	14.80	13.32	11.84
106 01 11	11 cm Ø	1 2000	42.00	37.80	33.60
		1000 =	21.00	18.90	16.80
106 01 14	14 cm Ø	1 2000	47.00	42.30	37.60
		1000 =	23.50	21.15	18.80
106 01 17	17 cm Ø	1 2000	56.00	50.40	44.80
		1000 =	28.00	25.20	22.40
106 01 19	19 cm Ø	1 2000	69.00	62.10	55.20
		1000 =	34.50	31.05	27.60
106 01 22	22 cm Ø	1 2000	79.00	71.10	63.20
		1000 =	39.50	35.55	31.60
106 01 27	27 cm Ø	1 2000	112.00	100.80	89.60
		1000 =	56.00	50.40	44.80
106 01 30	30 cm Ø	1 2000	139.00	125.10	111.20
		1000 =	69.50	62.55	55.60
106 01 32	32 cm Ø	1 2000	148.00	133.20	118.40
		1000 =	74.00	66.60	59.20
106 01 34	34 cm Ø	1 2000	179.00	161.10	143.20
		1000 =	89.50	80.55	71.60
		Stück			1
106 10 09	9 cm Ø	1 250			4.10
		100 =			1.64
106 10 11	11 cm Ø	1 250			5.80
		100 =			2.32
106 10 14	14 cm Ø	1 250			6.50
		100 =			2.60
106 10 17	17 cm Ø	1 250			7.80
		100 =			3.12
106 10 19	19 cm Ø	1 250			9.60
		100 =			3.84
106 10 22	22 cm Ø	1 250			11.00
		100 =			4.40
106 10 27	27 cm Ø	1 250			15.60
		100 =			6.24
106 10 30	30 cm Ø	1 250			19.30
		100 =			7.72
106 10 32	32 cm Ø	1 250			20.50
		100 =			8.20
106 10 34	34 cm Ø	1 250			24.90
		100 =			9.96

Coin Aqua Tissue - Ihren Gästen zuliebe

Coin Aqua Tissue - das aufsehenerregende Wohlfühltüchlein. Hergestellt aus 100% natürlichen Materialien sowie ohne jegliche Zusatzstoffe - ein absolut hygienisches Erfrischungstüchlein das vollständig biologisch entsorgt werden kann.

Coin Tissue verwandelt sich mit Wasser beträufelt in ein innovatives und hygienisches Wohlfühl-Tüchlein.



		Stück	1	6	12
				10 %	20 %
110 00 00		1 500	124.00	111.60	99.20
		100 =	24.80	22.32	19.84



Tischsets PVC

45 x 33 cm

			Stück	1	30	60
122 47 25	orange	6	1	4.80	4.32	3.84
122 47 55	apfelgrün	6	1	4.80	4.32	3.84
122 47 83	beige	6	1	4.80	4.32	3.84
122 47 85	braun	6	1	4.80	4.32	3.84
122 47 95	silber/grau	6	1	4.80	4.32	3.84
122 47 99	schwarz	6	1	4.80	4.32	3.84



Tischsets Chill

30 % PVC, 70 % Polyester, 45 x 30 cm

			Stück	1	30	60
122 38 01	schwarz/anthrazit	12	1	6.90	4.14	4.14
122 38 02	beige/olive/anthrazit	12	1	6.90	4.14	4.14
122 38 03	ecru/beige	12	1	6.90	4.14	4.14
122 38 04	schwarz/kupfer	12	1	6.90	4.14	4.14
122 38 05	gold/braun	12	1	6.90	4.14	4.14
122 38 06	schwarz/gold	12	1	6.90	4.14	4.14
122 38 07	schwarz	12	1	6.90	4.14	4.14

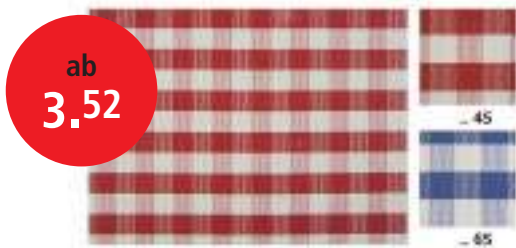

Tischsets PVC Karo

45 x 33 cm

			Stück	1	30	60
122 49 45	rot	6	1	4.40	3.96	3.52
122 49 65	blau	6	1	4.40	3.96	3.52



Tischsets Q-Look

PVC, Kuhfelloptik, abwaschbar

33 x 45 cm

			Stück	1	30	60
123 02 85	braun/weiss	1	1	13.00	10.40	10.40



Tischset Tierform

Tischset zweiseitig verwendbar, aus hochwertigem Kunstleder, wasserabweisend, einfaches Abwischen mit feuchten Tuch, 35 x 50 cm

			Stück	1	30	60
122 89 85	Kuhfelloptik	1	1	23.00	18.40	18.40



Tischsets Holzoptik

			Stück	1	30	60
122 90 84	Eiche	6	1	6.20	4.96	4.96
122 90 85	Ulme	6	1	6.20	4.96	4.96

Papierwaren / Take Away

Tischset Patchwork

PVC, Felloptik, abwaschbar
33 x 43 cm



NEW

		Stück		1
				20 %
122 89 00	Brauntöne	1	1	17.00 13.60

Tischsets Selection Damask

Voll im Trend - mit "Tapetenmuster" im Vintage Style. Tischsets zweiseitig verwendbar, aus hochwertigem Kunstleder, wasserabweisend, einfaches Abwischen mit feuchtem Tuch
32.5 x 44 cm

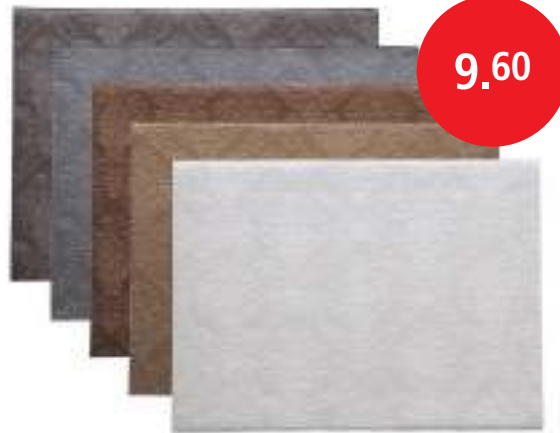

9.60

		Stück		1
				20 %
122 86 00	weiss	6	1	12.00 9.60
122 86 17	gold	6	1	12.00 9.60
122 86 86	bronze	6	1	12.00 9.60
122 86 90	silber	6	1	12.00 9.60
122 86 98	anthrazit	6	1	12.00 9.60

Tischsets Selection

Tischsets zweiseitig verwendbar, aus hochwertigem Kunstleder, wasserabweisend, einfaches Abwischen mit feuchtem Tuch
32.5 x 44 cm



		Stück		1
				20 %
122 80 85	braun	6	1	12.00 9.60
122 80 86	Horseback brown	6	1	12.00 9.60
122 81 99	Horseback black	6	1	12.00 9.60

Tischsets Selection Canvas

Die Tischsets Selection Canvas in schöner Leinenoptik. Tischsets zweiseitig verwendbar, aus hochwertigem Kunstleder, wasserabweisend, einfaches Abwischen mit feuchtem Tuch
32.5 x 44 cm



9.60

		Stück		1
				20 %
122 82 53	beige	6	1	12.00 9.60
122 82 85	braun	6	1	12.00 9.60
122 82 98	anthrazit	6	1	12.00 9.60

Tischsets Selection Nubuk

Tischsets zweiseitig verwendbar, aus hochwertigem Kunstleder in Wildleder-Optik, wasserabweisend, einfaches Abwischen mit feuchtem Tuch

32.5 x 44 cm



		Stück		1
				20 %
122 80 83	nubuk camel	6	1	10.80 8.64
122 80 84	nubuk braun	6	1	10.80 8.64
122 80 95	nubuk dunkel grau	6	1	10.80 8.64



Tischsets und Tischläufer Fleck-weg Swiss Alpes Vanille

Schön verarbeitete Tischsets in Leinenoptik, bügelfrei
100 % Polyester, 33 x 45 cm (Tischset), 45 x 130 cm (Tischläufer)

			Stück		1 20 %
124 09 47	33 x 45 cm, weinrot, Tischset	3	1	12.00	9.60
124 09 89	33 x 45 cm, chocolat, Tischset	3	1	12.00	9.60
124 08 47	45 x 130 cm, weinrot, Tischläufer	3	1	28.00	22.40
124 08 89	45 x 130 cm, chocolat, Tischläufer	3	1	28.00	22.40



Tischsets und Tischläufer Fleck-weg Swiss Alpes Beige

Schön verarbeitete Tischsets in Leinenoptik, bügelfrei
100 % Polyester, 33 x 45 cm Tischsets. 130 x 45 cm (Tischläufer)

			Stück		1 20 %
124 10 47	33 x 45 cm, weinrot, Tischset	3	1	12.00	9.60
124 10 89	33 x 45 cm, chocolat, Tischset	3	1	12.00	9.60
124 11 47	45 x 130 cm, weinrot, Tischläufer	3	1	28.00	22.40
124 11 89	45 x 130 cm, chocolat, Tischläufer	3	1	28.00	22.40



Tischtuch Fleck-weg Nearline Beige

Schön verarbeitete Tischwäsche in Leinenoptik, bügelfrei
100 % Polyester, Stoffbreite 145 cm.

			Stück		1 20 %
124 10 84	33 x 45 cm, Tischset	3	1	12.00	9.60
124 11 84	130 x 45 cm, Tischläufer	3	1	28.00	22.40
124 00 84	80 x 80 cm	1	1	48.00	38.40
124 01 84	100 x 100 cm	1	1	55.00	44.00
124 02 84	110 x 110 cm	1	1	58.00	46.40
124 03 84	160 x 120 cm	1	1	76.00	60.80
124 04 84	130 x 130 cm	1	1	66.00	52.80
124 05 84	170 x 130 cm	1	1	80.00	64.00



ab
10.40

Tischset Vintage

Stoff, in "used" Lederoptik, waschbar
33 x 45 cm

			Stück		1 20 %
123 00 84	café	1	1	13.00	10.40
123 00 85	chocolat	1	1	13.00	10.40
123 00 95	grau	1	1	13.00	10.40

Tischläufer Vintage

Stoff, in "used" Lederoptik, waschbar
45 x 120 cm

			Stück		1 20 %
123 01 84	café	3	1	26.00	20.80
123 01 85	chocolat	3	1	26.00	20.80
123 01 95	grau	3	1	26.00	20.80



Tischmolton Gastro

Geschäumter Kunststoff, mit Gewebeeinlage, rutscht nicht, Rolle à 15 m, waschbar bis 40° C.

			Stück		1 20 %
121 53 08	85 cm, Rolle à 15 m	1	1	208.00	166.40
121 53 13	130 cm, Rolle à 15 m	1	1	325.00	260.00
121 53 11	110 cm, Rolle à 15 m	1	1	289.00	231.20
121 53 17	170 cm, Rolle à 15 m	1	1	399.00	319.20

Papierwaren / Take-Away

Serviettenringe Rondo

CNS, matt-finish

	Stück	1			10			20		
		1 =			10 %		20 %			
121 60 10 4 cm Ø, Breite 2.8 cm	1	10	29.80	2.98	26.82	2.68	23.84	2.38		
121 60 11 4 cm Ø, Breite 1 cm	1	10	24.80	2.48	22.32	2.23	19.84	1.98		



ab
1.98

Serviettenringe Wave

CNS

	Stück	1			10			20		
		1 =			10 %		20 %			
121 60 05 6.5 x 3.5 cm, H: 4.5 cm	1	4	21.00	5.25	18.90	4.73	16.80	4.20		



Serviettenringe Cravattino

CNS

	Stück	1			10			20		
		1 =			10 %		20 %			
121 60 04 5.3 cm Ø, H: 4 cm	1	10	45.00	4.50	40.50	4.05	36.00	3.60		



ab
3.60

Serviettenringe Looping

Metall, verchromt

	Stück	1			10			20		
		1 =			10 %		20 %			
121 60 07 4.5 x 4.5 cm, H: 4 cm	1	4	16.00	4.00	14.40	3.60	12.80	3.20		



Serviettenringe Motion

Metall, verchromt

	Stück	1			10			20		
		1 =			10 %		20 %			
121 60 09 6.5 x 4.5 cm, H: 4 cm	1	6	37.00	6.17	33.30	5.55	29.60	4.93		



Serviettenringe Classico

Edelstahl, hochglanzpoliert

	Stück	1			10			20		
		1 =			10 %		20 %			
121 60 08 4.7 cm Ø, H: 4.5 cm	1	4	11.00	2.75	9.90	2.48	8.80	2.20		



Serviettentaschen

Halbkarton, mit Namensfeld

	Stück	1			3			6		
		100 =			5 %		10 %			
106 80 00 27 x 12 cm	1	250	59.00	23.60	56.05	22.42	53.10	21.24		



Stoff-Serviette Classic

Elegante Damast-Servietten mit Satinbordüre, abgepasst gewebt, 100 % Baumwolle, Zwirnketten, mercerisiert, Wascheingang ca. 5 %

50 x 50 cm, weiss

	Stück	1			10			20		
		1 =			5 %		10 %			
120 06 00 50 x 50 cm, Servietten	1	1			5.50		4.40			



4.40



Trinkbecher weich

Polypropylen, glasklar, unzerbrechlich

		Stück	1	3	6
700 27 01	Eichung: 1 dl	1 1000	124.00	111.60 10 %	99.20 20 %
700 00 02	Eichung: 2 dl	1 3000 1000 =	154.00 51.33	138.60 46.20	123.20 41.06
700 62 03	Eichung: 3 dl	1 1250 1000 =	132.00 105.60	118.80 95.04	105.60 84.48
700 62 05	Eichung: 5 dl	1 800 1000 =	132.00 165.00	118.80 148.50	105.60 132.00



Trinkbecher hart

Polystirol, glasklar, hart

		Stück	1	6	12
700 01 01	Eichung: 1 dl	1 1000	110.00	104.50 5 %	99.00 10 %
700 01 02	Eichung: 2 dl	1 1000	143.20	136.04	128.88
700 01 03	Eichung: 3 dl	1 500 100 =	110.00 22.00	104.50 20.90	99.00 19.80
700 02 04	Eichung: 1 dl	1 80			9.60
700 02 02	Eichung: 2 dl	1 100			15.60
700 02 03	Eichung: 3 dl	1 100			24.00



Kelchbecher

Glasklar, für Desserts, Glacen, Weissweine etc.

		Stück	1	3	6
700 05 18	1.8 dl	1 500 100 =	145.90 29.18	138.61 27.72	131.31 26.26
700 06 18	1.8 dl	1 100			32.00



Shot-/Degustationsbecher weich

Polypropylen, glasklar, unzerbrechlich

		Stück	1	3	5
700 47 04	Eichung: 2 + 4 cl	1 2000 100 =	175.00 8.75	166.25 8.31	157.50 7.88



Longdrinkglas Cocktail

PS Polystyrol - Temperaturbeständig von -10° C bis +70° C

		Stück	1	3	6
702 23 02	220 ml, Eichung: 2 dl	1 1000 100 =	178.00 17.80	160.20 16.02	142.40 14.24
702 23 03	350 ml, Eichung: 3 dl	1 420 100 =	135.00 32.14	121.50 28.93	108.00 25.71



Spezial-Becher

Glasklar, geeicht

		Stück	1	3	6
700 07 01	Champagner-Becher, Eichung: 1 dl	1 500 100 =	253.00 50.60	240.35 48.07	227.70 45.54
700 04 04	Longdrinkglas, Eichung: 2 + 4 cl	1 600 100 =	145.00 24.16	137.75 22.95	130.50 21.75



Isolier-Becher

Für Kalt- und Warmgetränke

		Stück	1	3	6
700 10 18	Eichung: 1.8 dl	1 1000	89.00	84.55 5 %	80.10 10 %
700 29 21	Eichung: 2 dl	1 1000	88.00	83.60	79.20
700 11 18	Eichung: 1.8 dl	1 100			9.90
700 11 20	Eichung: 2 dl	1 100			9.90

Papierwaren / Take-Away

Kartonbecher

Mit Henkel

		Stück	1	3	6
700 19 18	1.8 dl	1 2000	247.00	234.65	222.30
		1000 =	123.50	117.33	111.15
700 19 50	Deckel mit Dampfabzug	1 2000	169.00	160.55	152.10
		1000 =	84.50	80.28	76.05



Becher Coffee to go

Coffee to go Becher aus Karton, laminiert, stabil

		Stück	1	3	6
701 38 10	1 dl, Espresso	1 1000	99.00	89.10	79.20
		100 =	9.90	8.91	7.92
701 38 20	2 dl, Kaffee/Tee	1 1500	199.00	179.10	159.20
		100 =	13.27	11.94	10.61
701 38 30	3 dl, Cappuccino/Tee	1 1500	243.00	218.70	194.40
		100 =	16.20	14.58	12.96
701 38 40	4 dl, Latte Macchiato	1 1000	220.00	198.00	176.00
		100 =	22.00	19.80	17.60
701 39 23	Deckel für 701 38 20 / 701 38 30	1 1000	77.00	69.30	61.60
701 39 40	Deckel für 701 38 40	1 1000	88.00	79.20	70.40



Kaffeetassen

		Stück	1	3	6
700 16 15	Tassen-Einsätze, 1.5 dl	1 2500	188.00	169.20	150.40
		1000 =	75.20	67.68	60.16
700 15 15	Tassen-Einsätze, 1.5 dl	1 100			7.90
700 17 01	Kaffeetassen-Halter, schwarz	1 24	44.00	39.60	35.20



Einweg-Rührstäbchen

Kunststoff weiss

		Stück	1	4
700 24 00	110 mm	1 5000	65.00	52.00
		1000 =	13.00	10.40
700 24 10	110 mm	1 1000		16.00



Glacebecher

Bedruckte Glacebecher aus Karton

		Stück	1	3	5
700 48 10	100 g	1 1800	220.00	209.00	198.00
		100 =	12.22	11.61	11.00
700 48 20	200 g	1 1200	176.00	167.20	158.40
		100 =	14.67	13.93	13.20
700 48 35	350 g	1 1000	176.00	167.20	158.40
		100 =	17.60	16.72	15.84



Easy-Sommelier Becher

PS Polystyrol - Temperaturbeständig von -10° C bis +70° C

		Stück	1	3	6
702 21 01	Flute Champagner, Eichung: 1 dl	1 200	89.00	80.10	71.20
		100 =	44.50	40.05	35.60
702 22 00	Kelch Wasser/Wein, 200 ml	1 400	149.00	134.10	119.20
		100 =	37.25	33.53	29.80



50 ab
5.92



Einweg-Besteck Silber

Besteck aus PS Polystyrol in Metalloptik, robust

		Stück	1	24	48
				10 %	20 %
700 42 10	Gabel, 18.5 cm	1 50	7.40	6.66	5.92
700 42 20	Messer, 19.5 cm	1 50	7.40	6.66	5.92
700 42 30	Löffel, 17 cm	1 50	7.40	6.66	5.92
700 42 40	Kaffeelöffel, 13 cm	1 50	3.70	3.33	2.96
700 42 12	Kuchengabel, 13 cm	1 50	3.70	3.33	2.96



Mini Einweg-Besteck Silber

Besteck aus PS Polystyrol in Metalloptik, robust

		Stück	1	24	48
				10 %	20 %
700 43 10	Gabel, 10 cm	1 50	3.50	3.15	2.80
700 43 30	Löffel, 10 cm	1 50	3.50	3.15	2.80



Fingerfood-Mini-Besteck

10 cm, PS Polystyrol - Temperaturbeständig von -10° C bis +70° C

		Stück	1	3	6
				10 %	20 %
702 07 00	Gabel, weiss	1 1500 100 =	39.00 2.60	35.10 2.34	31.20 2.08
702 07 01	Gabel, transparent	1 1500	39.00	35.10	31.20
702 08 00	Löffel, weiss	1 1500	39.00	35.10	31.20
702 08 01	Löffel, transparent	1 1500	39.00	35.10	31.20
702 07 99	Gabel, schwarz	1 1500	39.00	35.10	31.20
702 08 99	Löffel, schwarz	1 1500	39.00	35.10	31.20

Einweg-Besteck

Weiss, robust, L: 167-176 mm



		Stück	1	3	6
				10 %	20 %
700 26 60	Gabel	1 2000	99.00	89.10	79.20
700 26 50	Messer	1 2000	99.00	89.10	79.20
700 26 70	Löffel	1 2000	99.00	89.10	79.20
700 26 40	Kaffeelöffel	1 2000	54.00	48.60	43.20
700 25 10	Gabel	1 100			5.90
700 25 20	Messer	1 100			5.90
700 25 30	Löffel	1 100			5.90
700 25 40	Kaffee-/ Dessertlöffel	1 100			4.00



Einweg-Besteck Set

Besteck-Set 3-teilig, glasklar aus PS
Messer, Gabel und Serviette

		Stück	1	3	6
				10 %	20 %
700 26 00	Besteck-Set, 3-teilig	1 250	72.00	64.80	57.60



Einweg-Teller Chinat

Der Umwelt zuliebe - Chinat Einweg-Teller aus Papierfasern, 100 % kompostierbar, biologisch abbaubar

- wasser- und fett dicht / - stabil und schnittfest / - geschmacksneutral

		Stück	1	3	6
				10 %	20 %
701 40 24	Teller flach, 23 cm Ø	1 800 100 =	154.00 19.25	138.60 17.33	123.20 15.40
701 40 26	Teller flach, 26 cm Ø	1 800 100 =	188.00 23.50	169.20 21.15	150.40 18.80

Papierwaren / Take-Away

Menüschalen schwarz PP

Menüschalen mit 1000 g Inhalt.
Aus Polypropylen PP, Temperaturbeständig von -40° C bis +110° C, mikrowellenfest
25.8 x 18.3 cm, H: 3.6 cm

	Stück	1	3	5
700 49 00 Menüschale ungeteilt	1 500 100 =	221.00 44.20	209.95 41.99	198.90 39.78
700 49 50 Deckel transparent zu 7004900	1 500 100 =	216.00 43.20	205.20 41.04	194.40 38.88
700 49 02 Menüschale 2-teilig	1 500 100 =	221.00 44.20	209.95 41.99	198.90 39.78
700 49 51 Deckel transparent zu 7004902	1 500 100 =	216.00 43.20	205.20 41.04	194.40 38.88



Take-away-Boxen Menu

EPS Polystyrol geschäumt, wärmeisolierend von -25° bis +85° C

23 x 19 cm

	Stück	1	6	12
700 46 00 ungeteilt, 23 x 19 cm, H: 7.5 cm	1 200 100 =	65.00 32.50	61.75 30.88	58.50 29.25
700 46 02 2-teilig, 23 x 19 cm, H: 7.5 cm	1 200	65.00	61.75	58.50



Take-away-Boxen Burger&Co.

EPS Polystyrol geschäumt, kälte- und wärmeisolierend von -25° bis +85° C

	Stück	1	3	6
700 60 14 14 x 14 cm, H: 7.5 cm	1 500 100 =	77.00 15.40	73.15 14.63	69.30 13.86
700 61 24 24 x 14 cm, H: 6.5 cm	1 500 100 =	99.00 19.80	94.05 18.81	89.10 17.82



Salatschalen mit Klappdeckel

Salatschalen aus PET Polyester
Temperaturbeständig von -40° C bis +60° C, kein Luftaustausch

	Stück	1	3	6
700 51 38 375 g, 13.5 cm Ø	1 600 100 =	170.00 28.33	161.50 26.92	153.00 25.50
700 51 50 500 g, 16 cm Ø	1 400 100 =	121.00 30.25	114.95 28.74	108.90 27.23
700 51 75 750 g, 18 cm Ø	1 300 100 =	121.00 40.33	114.95 38.32	108.90 36.30



Schalen 6-eckig

Mit Scharnierdeckel aus PP, Mikrowellenfest bis +120 °C

	Stück	1	3	6
700 59 50 500 ml	1 300 100 =	133.00 44.33	126.35 42.12	119.70 39.90
700 59 75 750 ml	1 300 100 =	154.00 51.33	146.30 48.77	138.60 46.20



Wurst- und Patisserie Kartonteller

weiss, laminiert, ideal für Grillwürste

	Stück	1	6	12
700 40 11 11 x 17 cm	1 250 100 =	12.00 4.80	10.80 4.32	9.60 3.84
700 40 13 13 x 20 cm	1 250 100 =	14.00 5.60	12.60 5.04	11.20 4.48
700 41 13 13 x 13 cm	1 250 100 =	12.90 5.16	11.61 4.64	10.32 4.13





100 ab
11.52



Fingerfood-Schälchen Heart

8 x 7.5 cm
PS Polystyrol - Temperaturbeständig von -10° C bis +70° C

	Stück	1	3	6
702 10 00 weiss	1 500 100 =	72.00 14.40	64.80 12.96	57.60 11.52
702 10 01 transparent	1 500	72.00	64.80	57.60
702 10 99 schwarz	1 500	72.00	64.80	57.60



Fingerfood-Schale

3-teilig, 17 x 10 cm
PS Polystyrol - Temperaturbeständig von -10° C bis +70° C

	Stück	1	3	6
702 02 00 weiss	1 500 100 =	99.00 19.80	89.10 17.82	79.20 15.84
702 02 01 transparent	1 500	99.00	89.10	79.20
702 02 99 schwarz	1 500	99.00	89.10	79.20

Papierwaren / Take-Away

Fingerfood-Becher Blossom

90 ml, H: 6.2/8.5 cm, 5.5 cm Ø

PS Polystyrol - Temperaturbeständig von -10° C bis +70° C

		Stück	1	3	6
				10 %	20 %
702 03 00	weiss	1 300	73.00	65.70	58.40
		100 =	24.33	21.90	19.46
702 03 01	transparent	1 300	73.00	65.70	58.40
702 03 99	schwarz	1 300	73.00	65.70	58.40



Fingerfood-Amuse-Bouche Löffel

15 ml, 12 x 3.8 cm

PS Polystyrol - Temperaturbeständig von -10° C bis +70° C

		Stück	1	3	6
				10 %	20 %
702 25 00	weiss	1 600	89.00	80.10	71.20
		100 =	14.83	13.35	11.86
702 25 01	transparent	1 600	89.00	80.10	71.20
702 25 99	schwarz	1 600	89.00	80.10	71.20



Fingerfood-Löffel Fisch

20 ml, 12 x 3.7 cm

PS Polystyrol - Temperaturbeständig von -10° C bis +70° C

		Stück	1	3	6
				10 %	20 %
702 24 00	weiss	1 600	89.00	80.10	71.20
		100 =	14.83	13.35	11.86
702 24 01	transparent	1 600	89.00	80.10	71.20
702 24 99	schwarz	1 600	89.00	80.10	71.20



Fingerfood-Teller Square

150 ml, 8 x 5.9 cm

PS Polystyrol - Temperaturbeständig von -10° C bis +70° C

		Stück	1	3	6
				10 %	20 %
702 05 00	weiss	1 500	65.00	58.50	52.00
		100 =	13.00	11.70	10.40
702 05 01	transparent	1 500	65.00	58.50	52.00
702 05 99	schwarz	1 500	65.00	58.50	52.00



Fingerfood-Schälchen Dreieck

8.5 cm

PS Polystyrol - Temperaturbeständig von -10° C bis +70° C

		Stück	1	3	6
				10 %	20 %
702 18 00	weiss	1 500	68.00	61.20	54.40
		100 =	13.60	12.24	10.88
702 18 01	transparent	1 500	68.00	61.20	54.40
702 18 99	schwarz	1 500	68.00	61.20	54.40



Fingerfood-Tellerchen Square

6.5 x 6.5 cm

PS Polystyrol - Temperaturbeständig von -10° C bis +70° C

		Stück	1	3	6
				10 %	20 %
702 14 00	weiss	1 750	79.00	71.10	63.20
		100 =	10.53	9.48	8.42
702 14 01	transparent	1 750	79.00	71.10	63.20
702 14 99	schwarz	1 750	79.00	71.10	63.20



100 ab
8.42



Fingerfood-Teller Square

13 x 13 cm

PS Polystyrol - Temperaturbeständig von -10° C bis +70° C

		Stück	1	3	6
702 15 00	weiss	1 192 100 =	67.00 34.90	60.30 31.41	53.60 27.92
702 15 01	transparent	1 192	67.00	60.30	53.60
702 15 99	schwarz	1 192	67.00	60.30	53.60



Fingerfood-Bowl Round

150 ml, H: 4.2 cm, 8.2 cm Ø

PS Polystyrol - Temperaturbeständig von -10° C bis +70° C

		Stück	1	3	6
702 04 00	weiss	1 144 100 =	49.00 34.03	44.10 30.63	39.20 27.22
702 04 01	transparent	1 144	49.00	44.10	39.20
702 04 99	schwarz	1 144	49.00	44.10	39.20



Fingerfood-Schälchen konisch

50 ml, 9.4 x 7.2 cm, H: 2/3 cm

PS Polystyrol - Temperaturbeständig von -10° C bis +70° C

		Stück	1	3	6
702 06 00	weiss	1 500 100 =	66.00 13.20	59.40 11.88	52.80 10.56
702 06 01	transparent	1 500	66.00	59.40	52.80
702 06 99	schwarz	1 500	66.00	59.40	52.80



Fingerfood-Schale Rombo

95 ml, 5.5 x 5.5 cm, H: 5.5 cm

PS Polystyrol - Temperaturbeständig von -10° C bis +70° C

		Stück	1	3	6
702 11 00	weiss	1 500 100 =	92.00 18.40	82.80 16.56	73.60 14.72
702 11 01	transparent	1 500	92.00	82.80	73.60
702 11 99	schwarz	1 500	92.00	82.80	73.60



100 ab
12.64

Fingerfood-Schale Tulip

70 ml, 6.5 cm, H: 4.4 cm

PS Polystyrol - Temperaturbeständig von -10° C bis +70° C

		Stück	1	3	6
702 12 00	weiss	1 500 100 =	79.00 15.80	71.10 14.22	63.20 12.64
702 12 01	transparent	1 500	79.00	71.10	63.20
702 12 99	schwarz	1 500	79.00	71.10	63.20



Mini-Coupe Viva

66 ml

PS Polystyrol - Temperaturbeständig von -10° C bis +70° C

		Stück	1	3	6
702 13 00	transparent	1 240 100 =	139.00 57.92	125.10 52.13	111.20 46.34



Fingerfood-Schale rund

60 ml, 6.7 cm Ø, H: 4 cm

PS Polystyrol - Temperaturbeständig von -10° C bis +70° C

		Stück	1	3	6
702 16 00	weiss	1 210 100 =	35.00 16.67	31.50 15.00	28.00 13.34
702 16 01	transparent	1 210	35.00	31.50	28.00
702 16 99	schwarz	1 210	35.00	31.50	28.00

Papierwaren / Take-Away

Fingerfood-Cocktail-Teller

oval, 25.5 x 19 cm

PP Polypropylen - Temperaturbeständig von -20° C bis +120° C, mikrowellenfest

		Stück	1	3	6
702 09 00	weiss	1 600	198.00	178.20	158.40
		100 =	33.00	29.70	26.40
702 09 99	schwarz	1 600	198.00	178.20	158.40



Easy-Sommelier Becher

PS Polystyrol - Temperaturbeständig von -10° C bis +70° C

		Stück	1	3	6
702 21 01	Flute Champagner, Eichung: 1 dl	1 200	89.00	80.10	71.20
		100 =	44.50	40.05	35.60
702 22 00	Kelch Wasser/Wein, 200 ml	1 400	149.00	134.10	119.20
		100 =	37.25	33.53	29.80



Fingerfood-Design Tassen

PS Polystyrol - Temperaturbeständig von -10° C bis +70° C

		Stück	1	3	6
702 19 99	Espressotasse, schwarz, 72 ml	1 240	44.00	39.60	35.20
		100 =	18.33	16.50	14.66
702 20 99	Kaffeetasse, schwarz, 155 ml	1 144	36.00	32.40	28.80
		100 =	25.00	22.50	20.00



Servier-Platte Rock

PS Polystyrol - Temperaturbeständig von -10° C bis +70° C

		Stück	1	3	6
702 00 13	13 x 9 cm	1 240	69.00	62.10	55.20
		1 =	0.29	0.26	0.23
702 00 22	22 x 14 cm	1 100	84.00	75.60	67.20
702 00 30	30 x 16 cm	1 100	99.00	89.10	79.20



Stehtisch Party

Einfaches Aufbauen dank Stecksystem, leichtes Transportieren und platzsparend lagern, Gestell verchromt, stabile Tischplatte aus Kunststoff.

Der passende Stehtischbezug in weiss verleiht dem Event einen Hauch von Eleganz
Material: 90 % Micropolyester, 10 % Elasthan, waschbar bis 40 °C, bügelfrei

		Stück	1	1
730 62 70	Stehtisch Party, 70 cm Ø, H: 117 cm	1 1		139.00
730 62 00	Stehtischbezug weiss	1 1		48.00



Toilette / Reinigung

ALPHAmatic



vileda

Blidesin



brabantia



dyson airblade

premStar

etolit

VERWO



Hygiene Reinigung

Toilettenartikel
Reinigung
Toilettenpapier
Handtuchpapier
Abfall

hulu Toilettenpapier

Mit mehr Coupons auf der Rolle! Braucht weniger Platz und weniger Rollenwechsel.
Vergleichen Sie den Preis per 100 Coupons!



hulu Recycling Tissue 1a, 2-lagig

100% Recycling-Papier, weiss, Mikroprägung

		Stück	1	21	42	
610 32 02	Lagen: 2, Coupons: 400, 12.5 x 10 cm, 2 x 17.5 g/m ²	1	30 1 =	19.90 0.66	17.91 0.59	14.93 0.50
				10 %	25 %	



hulu Recycling Tissue 1a, 3-lagig

100% Recycling-Papier, weiss, Mikroprägung

		Stück	1	21	42	
610 33 03	Lagen: 3, Coupons: 250, 12 x 9.8 cm, 3 x 17.5 g/m ²	1	30 1 =	19.90 0.66	17.91 0.59	14.93 0.50
				10 %	25 %	



hulu Soft Tissue, 3-lagig

100% Tissue, weiss, Mikroprägung

		Stück	1	12	24	
610 32 03	Lagen: 3, Coupons: 250, 12.5 x 9.8 cm, 3 x 17 g/m ²	1	60 1 =	44.00 0.73	39.60 0.66	35.20 0.58
				10 %	20 %	



Toilettenpapier 143 plus, 3-lagig

100% Zellstoffwatte, weiss. Flauschiger, weicher, weniger Verbrauch!
Triple Drop Prägung

		Stück	1	18	36	
610 38 03	Lagen: 3, Coupons: 143, 12.5 x 10 cm, 3 x 17.5 g/m ²	1	42 1 =	39.00 0.93	35.10 0.84	29.25 0.70
				10 %	25 %	



Toilettenpapier Soft-Prägung Cosy, 3-lagig

100% Tissue, weiss, weich und sehr reissfest

		Stück	1	12	24	
610 37 03	Lagen: 3, Coupons: 300, 11.5 x 9.7 cm, 3 x 17 g/m ²	1	60 1 =	56.00 0.93	50.40 0.84	44.80 0.75
				10 %	20 %	



Toilettenpapier Soft-Prägung Cosy, 4-lagig

100% Tissue, weiss, weich und sehr reissfest

		Stück	1	12	24	
610 37 04	Lagen: 4, Coupons: 150, 13.5 x 9.8 cm, 3 x 17 g/m ²	1	60 1 =	51.00 0.85	45.90 0.77	40.80 0.68
				10 %	20 %	



WC-Rollen-Halter

Mit Ersatzrollenautomatik, Sichtfenster und Sicherheitsverschluss, für Standard-WC-Rollen
Dank Abrollbremse kein Entrollen

		Stück	1	
611 15 02	CNS matt, gebürstet, für: 2 Rollen, 11.6 x 12.7 cm, H: 28.8 cm	1	1	98.00
611 15 03	CNS matt, gebürstet, für: 3 Rollen, 11.6 x 12.7 cm, H: 38 cm	1	1	119.00



Toilettenpapier Comfort, 3-lagig

100% Zellstoff, weiss

Der Umwelt zuliebe! Dieses Toilettenpapier ist PEFC zertifiziert und stammt aus nachhaltig bewirtschafteten Wäldern und kontrollierten Quellen

		Stück		1
610 46 13	Lagen: 3, Coupons: 250, 11.3 x 9.8 cm	1	72	44.00 35.20 20 %

1 Rolle
0.49





WC-Rollenhalter

CNS 18/10

	Stück	1	12	30
612 16 00* H: 21 cm	1	1	31.50	28.35
				25.20



hulu Jumbo WC-Rollen

2-lagig, hochweiss, perforierte Grossrollen, Länge der Rolle 350 m, entspricht 946 Blatt

	Stück	1	18	36
610 40 02 26 cm Ø, 2 x 17.5 g/m2	1	6	36.80	33.12
		1 =	6.13	5.52
				27.60



Spender für WC-Rollen Jumbo

	Stück	1	1
610 42 36 Stahlblech, weiss, 12 cm, 30 cm Ø	1	1	75.00
610 41 30 CNS 18/10, 12.8 cm, 30 cm Ø	1	1	149.00



611 70 00



611 72 00



611 70 50

WC-Besen-Garnituren

	Stück	1	12	30
611 70 00 Garnitur weiss, 14 x 14 cm, H: 40 cm	1	1	11.00	10.45
611 72 00* Garnitur Futura, weiss, 10 x 15 cm, H: 37 cm	1	1	11.20	10.64
				10.08
611 70 50 Ersatzbürste zu 611 70 00 + 611 72 00	1	1		4.20



611 24 00



611 21 01



611 22 00

WC-Besen-Garnituren

	Stück	1	12	30
611 24 00 Wandmodell, verchromt, Kunststoff, H: 38 cm	1	1	59.90	53.91
				47.92
611 24 50 Ersatzbürstenkopf zu 611 24 00	1	1		7.40
611 21 01 Intense, CNS, H: 39 cm	1	1	35.00	31.50
				28.00
611 24 51 Ersatzbürstenkopf zu 611 21 01	1	1		6.80
611 22 00 CNS, 13.5 cm Ø, H: 42.5 cm	1	1		84.00
611 22 50 Ersatzbesen mit Randreiniger für 6112200, 6117000, 6117200	1	1		6.40
				6.40
611 74 50 Ersatzbürste mit Stiel, 6.5 cm Ø	1	1		4.60



611 22 50



611 74 50

Hygiene / Reinigung

Hinweisschilder

CNS, 13 x 13 cm

		Stück	1	12	30
				5 %	10 %
202 09 00	Damen	1	1	14.00	8.00
202 09 01	Herren	1	1	14.00	8.00
202 09 02	Rollstuhlfahrer	1	1	14.00	8.00
202 09 07	Babywickelraum	1	1	14.00	8.00



Abfallboy Lux

Edelstahl poliert, mit herausnehmbarem Kunststoffeinsatz

		Stück	1	12	30
				5 %	10 %
610 56 03	3 l, 17 cm Ø, H: 25 cm	1	1	35.50	33.73
610 56 05	5 l, 20 cm Ø, H: 29 cm	1	1	44.50	42.28
		Stück	1	10	30
				5 %	10 %
610 50 50	Einlagebeutel, 19 x 19 cm, H: 38 cm	1	100	11.90	11.31



Abfallboy Hit

Edelstahl poliert, mit herausnehmbarem Kunststoffeinsatz

		Stück	1	12	30
				10 %	20 %
610 55 03	3 l, 17 cm Ø, H: 25 cm	1	1	29.90	26.91
610 55 05	5 l, 20 cm Ø, H: 29 cm	1	1	39.90	35.91
		Stück	1	10	30
				5 %	10 %
610 50 50	Einlagebeutel, 19 x 19 cm, H: 38 cm	1	100	11.90	11.31



Toiletten-Abfallboy

Kunststoff weiss, mit herausnehmbarem Einsatz

		Stück	1	12	30
				5 %	10 %
610 80 05	5 l, 24.6 x 21 cm, H: 27.7 cm	1	1	22.00	20.90
		Stück	1	10	30
				5 %	10 %
610 50 50	Einlagebeutel, 19 x 19 cm, H: 38 cm	1	100	11.90	11.31



Plastik-Einlegesäcke für Abfallkörbe

		Stück	1	6	12
				10 %	20 %
620 10 18	Plastik-Einlegesack, 22 l, Grösse 50 x 56 cm	1	800	29.80	26.82
			100 =	3.73	3.36
620 10 33	Plastik-Einlegesack, 33 l, Grösse 55 x 60 cm	1	600	28.00	25.20
			100 =	4.67	4.20
620 12 55	Plastik-Einlegesack, 55 l, Grösse 60 x 77 cm	1	400	33.00	29.70
			100 =	8.25	7.43
620 11 70	Plastik-Einlegesack, 70 l, Grösse 61 x 93 cm	1	400	50.90	45.81
620 11 77	Plastik-Einlegesack, 77 l, Grösse 66 x 91 cm	1	600	69.00	62.10
			100 =	11.50	10.35



Einlagebeutel

Die zeitsparende, saubere Lösung

		Stück	1	10	30
				5 %	10 %
610 50 50	Einlagebeutel, 19 x 19 cm, H: 38 cm	1	100	11.90	11.31



ab
5.52



Hygienebeutel-Spender

Kunststoff

		Stück	1	50	100
610 75 90	Verchromt, 13.5 x 2.8 cm, H: 9.5 cm	1	1	11.00	8.80
610 75 00	weiss, 13.5 x 2.8 cm, H: 9.5 cm	1	1	6.90	5.52
610 76 00	Nachfüllpackung Hygiene-Plastikbeutel, Einzelpaket: 25 Stk. x 48 = 1'200 Beutel	1	1200 25 =		59.80 1.25



hulu Hygiene-Halter und Beutel

Metalldraht, verchromt

		Stück	1	12	30
610 78 90	Halter verchromt, 16.5 x 4 cm, H: 22 cm	1	1	12.90	11.61
610 79 00	Hygiene-Beutel weiss, Schriftzug in 4 Sprachen, 28 x 14 cm	1	1000		41.00



hulu Handtuchspender

Kunststoff weiss, mit Schloss

Midi bis zu 160 Handtücher

Maxi bis zu 280 Handtücher

		Stück	1	
611 56 01	Midi, 29 x 14.5 cm, H: 26.5 cm	1	1	45.00
611 55 01	Maxi, 29 x 14.5 cm, H: 42.5 cm	1	1	52.00



Handtuchspender CNS

Mit Sicherheitsverschluss, für ca. 400 - 600 Handtücher

		Stück	1	
611 05 00	CNS 18/10, matt gebürstet, 27.5 x 13.3 cm, H: 33 cm	1	1	129.00



Händetrockner Optima

Formschön, leise, vollautomatische Händetrocknung, mit Sensorschaltung, 4000 l Luft pro Minute

		Stück	1	
611 60 00	Weiss, Stahl emailliert, 25.5 x 14 cm, H: 30.2 cm, 230 V, 1650 W, 4.2 kg	1	1	370.00 296.00
611 10 00*	CNS matt, gebürstet, 25.5 x 14 cm, H: 30.2 cm, 230 V, 1650 W, 4.2 kg	1	1	479.00 383.20

Hygiene / Reinigung

ZZ-Falz Tissuehandtücher weiss

Tolle Qualität zum Superpreis! Aus 100 % Zellulose, hochweiss, sehr saugfähig und angenehm in der Hand.
Optimales Preis-Leistungsverhältnis. Mit ZZ-Falz für praktisches Entnehmen eines Handtuches für weniger Verbrauch!

1000 ab
9.-



	Stück	1	24	36
			10 %	25 %
610 69 02 Lagen: 2, 2 x 20 g/m ²	1 3000 1000 =	36.00 12.00	32.40 10.80	27.00 9.00

Non-Stop-Sky Handtücher 2-lagig

Spezialfaltung, die pro Handgriff nur ein einziges Handtuch frei gibt! Es ist nicht möglich, mehrere Handtücher auf einmal herauszuziehen. Bis 30 % weniger Verbrauch, bis 30 % günstiger, weniger oft nachfüllen

NEW



Geprägt, 23.5 x 24 cm, ungebleicht, EU Ecolable

	Stück	1	10	21
			10 %	25 %
610 59 22 Lagen: 2, 2 x 21.5 g/m ²	1 3000 1000 =	35.00 11.67	31.50 10.50	26.25 8.75

Non-Stop-Handtücher 1-lagig

Spezialfaltung, die pro Handgriff nur ein einziges Handtuch frei gibt! Es ist nicht möglich, mehrere Handtücher auf einmal herauszuziehen. Bis 30 % weniger Verbrauch, bis 30 % günstiger, weniger oft nachfüllen

Geprägt, 23.5 x 24 cm, ungebleicht



	Stück	1	10	21
			10 %	25 %
610 60 01 Lagen: 1, 40 g/m ²	1 4500 1000 =	62.00 13.77	55.80 12.40	46.50 10.33

Handtücher 100 % Tissue, 2-lagig, weiss

Spezial-Falztechnik gewährleistet einen kontrollierten Verbrauch und bewirkt, dass der Verbraucher nur das Handtuch berührt, das er verwendet



	Stück	1	16	32
			10 %	20 %
610 62 02 One Stop M2, Lagen: 2, 2 x 22 g/m ² , weiss	1 3045 1000 =	55.00 18.06	49.50 16.26	44.00 14.45

Handtücher 100 % Tissue, 2-lagig, hochweiss

Spezial-Falztechnik gewährleistet einen kontrollierten Verbrauch und bewirkt, dass der Verbraucher nur das Handtuch berührt, das er verwendet



	Stück	1	14	28
			10 %	20 %
610 64 02 One Stop M2 Plus, Lagen: 2, 2 x 24 g/m ² , hochweiss	1 3045 1000 =	59.00 19.38	53.10 17.44	47.20 15.50

V-Falz-Papierhandtücher

Die preisgünstige Variante!



	Stück	1	14	28
			10 %	25 %
610 62 01 Lagen: 1, 25 x 23 cm, grau, 40 g/m ²	1 5000 1000 =	36.90 7.38	33.21 6.64	27.68 5.54

ab
27,30



hulu Abfallkorb

Metalldraht verchromt

		Stück	1	6	12
611 96 43	Verchromt, 33 x 23 cm, H: 43 cm	1	1	39.00	27.30
620 12 55	Plastik-Einlegesack, 55 l, H: 77 cm	1	400 100 =	33.00 8.25	29.70 7.43
611 96 63	Verchromt, 41.5 x 26 cm, H: 62 cm	1	1	55.00	38.50
620 11 77	Plastik-Einlegesack, 77 l, H: 91 cm	1	600 100 =	69.00 11.50	62.10 10.35



Abfalleimer CNS

CNS 18/10 matt, gebürstet, für die Montage an der Wand

		Stück	1	6	12
611 94 25	25 l, 35.5 x 15.5 cm, H: 46 cm	1	1		259.00
620 12 55	Plastik-Einlegesack, 55 l, H: 77 cm	1	400 100 =	33.00 8.25	29.70 7.43



Abfalleimer

Kunststoff weiss

		Stück	1	6	12
611 98 43	43 l, H: 61 cm, 40 x 28 cm	1	1	56.00	50.40
620 11 70	Plastik-Einlegesack, 70 l, H: 92 cm	1	400	50.90	45.81

Abfalleimer mit Wippdeckel, Kunststoff

silber/anthrazit



		Stück	1	6	12
611 99 10	Abfalleimer 10 l, 24.6 x 19.8 cm, H: 37.3 cm	1	1	11.50	10.93
611 99 25	Abfalleimer 25 l, 33.2 x 26.8 cm, H: 41 cm	1	1	23.50	22.33
611 99 50	Abfalleimer 50 l, 40.6 x 34 cm, H: 66.8 cm	1	1	43.50	41.33
620 10 18	Plastik-Einlegesack, 22 l, Grösse 50 x 56 cm, für 611 99 10	1	800 100 =	29.80 3.73	26.82 3.36
620 10 33	Plastik-Einlegesack, 33 l, H: 60 cm, für 611 99 25	1	600 100 =	28.00 4.67	25.20 4.20
620 11 70	Plastik-Einlegesack, 70 l, H: 92 cm, für 611 99 50	1	400 100 =	50.90 12.73	45.81 11.46



Abfalleimer Touch Bin CNS

CNS 18/10, matt, mit Kunststoffeinsatz

		Stück	1	6	12
611 95 40	Mit Deckel, 40 l, H: 73 cm, 43 cm Ø	1	1		239.00
620 11 70	Plastik-Einlegesack, 70 l, H: 92 cm	1	400	50.90	45.81

Hygiene / Reinigung

hulu Schaum-Seifenspender Toilette

Grosse Einsparung an Seife!
Mit Sicherheitsverschluss, 0.5 ml Seife werden auf das 17-fache Volumen aufgeschäumt

		Stück			1	
					35 %	
611 50 00	Kunststoff, 7.1 x 10.3 cm, H: 33 cm	1	1	99.00	64.35	
		Stück			1	
611 03 00	CNS 18/10 matt, gebürstet, 7.1 x 10.3 cm, H: 33 cm	1	1		198.00	
		Stück	1	6	12	
				5 %	10 %	
611 30 06	Seifenschäumkonzentrat , 650 ml	1	9	69.50	66.03	62.55
			1 =	7.72	7.33	6.95



hulu Flüssig-Seifenspender Küche

Perfekte Handhygiene für die Profi-Küch.
Das Reinigungs- u. Desinfektions-Konzentrat reinigt und dekontaminiert, d.h. es ist antimikrobiell wirksam gegen Bakterien, sparsam in der Anwendung da konzentriert, sehr wirksam, dermatologisch geprüft

		Stück			1	
					35 %	
611 58 01	Kunststoff, 7.1 x 10.3 cm, H: 33 cm	1	1	99.00	64.35	
		Stück			1	
611 59 01	CNS 18/10 matt, gebürstet, 7.1 x 10.3 cm, H: 33 cm	1	1		198.00	
		Stück	1	6	12	
				5 %	10 %	
611 32 06	Reinigungs- u. Desinfektions-Konzentrat, 650 ml	1	9	165.00	156.75	148.50
			1 =	18.33	17.41	16.50



Seifenspender Alphamouss XL

Das elegante System mit 2 l Inhalt für Sporthallen und Fitnesscenter, Pumpe wartungs- und abnützungsfrei

		Stück			1	
611 80 00	Spender XL, 17.6 x 9.9 cm, H: 36.2 cm	1	1		69.90	
		Stück	1	6	12	
				10 %	20 %	
611 82 20	Seife extra mild, 2000 ml	1	6	89.80	80.82	71.84
			1 =	14.97	13.47	11.98
611 83 20	Duschgel und Shampoo, 2000 ml	1	6	109.70	98.73	87.76
			1 =	18.28	16.45	14.62



Seifencrème

Rosa Perlmutterglanz, parfümiert, hautschonend, konzentriert

		Stück	1	6	12	
				10 %	20 %	
611 47 50	Bidon à 5 l, extra mild	1	1	27.80	25.02	22.24





Katrin System

Katrin System – Spender und Papiere, die perfekt zueinander passen.

Katrin ist der Spezialist für Frische, Wohlbefinden und Funktionalität in grossen und kleinen Waschräumen. Erste Wahl für besonders hoch frequentierte Waschräume sind die Katrin Systemspender, die eine hygienische Anwendung und hohe Kapazität gewährleisten.

Alle Vorteile auf einen Blick

- +++ äusserst funktional gestaltet und komfortabel für jeden Nutzer
- +++ einfache Installation und Wartung
- +++ problemlose Reinigung und Instandhaltung
- +++ hohe Wirtschaftlichkeit durch kontrollierten Verbrauch
- +++ Haltbarkeit, Sicherheit und Handling sind zertifiziert
- +++ gut erreichbar und leicht bedienbar
- +++ leichtes Nachfüllen
- +++ schönes Design in weiss oder schwarz
- +++ zu 100 % recycelbar



KATRIN

Handtuchrollenspender Katrin System

Für 1 Handtuchrolle

Handtücher sind immer sauber und unberührt. Dank dem gut konzipierten System werden die Rollen vollständig aufgebraucht und sind leicht nach zu füllen

		Stück	1	16	32
610 02 00	Handtuchrollenspender weiss, 33.5 x 21.6 cm, H: 40.3 cm	1	1	106.00	
610 02 99	Handtuchrollenspender schwarz, 33.5 x 21.6 cm, H: 40.3 cm	1	1	106.00	



KATRIN

Handtuchrollen Katrin System

Voluminöses, weiches und extrastarkes Tissue-Papier, weiss, für die hygienische und extraschnelle Trocknung, ein Blatt reicht zur Händetrocknung

		Stück	1	16	32
610 05 00	B: 23.6 cm, Lagen: 2, 2 x 23 g/m ² , Coupons: 680	1	6 1 =	75.00 12.50	60.00 10.00 10 % 20 %
610 07 00	B: 21 cm, Lagen: 2, 2 x 31 g/m ² , Coupons: 420	1	6	75.00	60.00



KATRIN

Handtuchspender Katrin System

		Stück	1	16	32
610 03 00	Handtuchspender weiss, 30.1 x 14.6 cm, H: 45 cm	1	1	53.00	
610 03 99	Handtuchspender schwarz, 30.1 x 14.6 cm, H: 45 cm	1	1	53.00	



Handtücher 100 % Tissue, 2-lagig, weiss

Spezial-Falztechnik gewährleistet einen kontrollierten Verbrauch und bewirkt, dass der Verbraucher nur das Handtuch berührt, das er verwendet

		Stück	1	16	32
610 62 02	One Stop M2, Lagen: 2, 2 x 22 g/m ² , weiss	1	3045 1000 =	55.00 18.06	44.00 14.45 10 % 20 %
610 64 02	One Stop M2 Plus, Lagen: 2, 2 x 24 g/m ² , hochweiss	1	3045 1000 =	59.00 19.38	47.20 15.50

Hygiene / Reinigung

WC-Rollenspender Katrin System

Für zwei Langzeitrollen Toilettenpapier, mit Ersatzrollenautomatik, Sichtfenster, Reibungsbremse, die das Nachlaufen verhindert

Code	Produkt	Stück	Preis
610 13 00	WC-Rollenspender weiss, 15.4 x 17.4 cm, H: 31.3 cm	1	53.00
610 13 99	WC-Rollenspender schwarz, 15.4 x 17.4 cm, H: 31.3 cm	1	53.00



WC-Rollen Katrin System

Code	Produkt	Stück	Preis	15 %	30 %
610 16 02	Lagen: 2, Coupons: 800, 13.5 cm Ø, 9.9 x 12 cm	1	96.00	86.40	76.80
610 16 03	Lagen: 3, Coupons: 500, 13.5 cm Ø, 9.9 x 12 cm	1	113.00	101.70	90.40

Toilettensitz-Reinigungsschaum Katrin

Mit antibakterieller Wirkung

Code	Produkt	Stück	Preis
611 36 05	Toilettensitz-Reinigungsschaum 500 ml	1	178.00
611 33 00	Seifenspender weiss, 10 x 12.5 cm, H: 20.4 cm, 500 ml	1	31.00
611 33 99	Seifenspender schwarz, 10 x 12.5 cm, H: 20.4 cm, 500 ml	1	31.00



Duftspender Katrin Easy

Code	Produkt	Stück	Preis
612 02 00	Duftspender weiss, 9.4 x 8 cm, H: 19.2 cm	1	53.00
612 02 99	Duftspender schwarz, 9.4 x 8 cm, H: 31.3 cm	1	53.00
612 03 00	Wirkstoffdosen Citrus	1	81.00



Seifenspender Katrin

Code	Produkt	Stück	Preis
611 33 00	Seifenspender weiss, 10 x 12.5 cm, H: 20.4 cm, 500 ml	1	31.00
611 33 99	Seifenspender schwarz, 10 x 12.5 cm, H: 20.4 cm, 500 ml	1	31.00
611 35 05	Handwaschseife, 500 ml	1	76.00
611 37 05	Handwaschschaum, 500 ml	1	92.00



Seifenspender Katrin

Code	Produkt	Stück	Preis
611 34 00	Seifenspender weiss, 1000 ml, 10 x 13 cm, H: 29.1 cm	1	42.00
611 34 99	Seifenspender schwarz, 1000 ml, 10 x 13 cm, H: 29.1 cm	1	42.00
611 35 10	Handwaschseife, 1000 ml	1	63.00
611 37 10	Handwaschschaum, 1000 ml	1	85.00



Hygiene-Beutelspender und Abfallboy

Die saubere Lösung! Hygienebeutel-Dispenser und Abfallboy in einem, für eine hygienische, geruchlose Entsorgung von Hygienebeuteln. Passende Hygienebeutel und Abfallsäcke gleich mitbestellen

Code	Produkt	Stück	Preis
610 25 01	Hygiene-Beutelspender, 28.5 x 11.4 cm, H: 27.9 cm	1	46.00
610 25 50	Abfallsäcke mit Gripverschluss	1	92.00
610 25 51	Hygienebeutel verschliessbar	1	106.00





Spender Smart

Eleganter und platzsparender Dosierspender für tropfsichere und einfach zu wechselnde Einwegpatronen, unzerbrechlich, aus Polycarbonat
Optimal geeignet für Hotelzimmer, Dusche, Bad, Toiletten etc.

		Stück	1	12	24
611 86 00	Spender weiss, 8,7 x 6,5 cm, H: 16,5 cm	12	1	49.50	15.60
611 86 90	Spender silber, 8,7 x 6,5 cm, H: 16,5 cm	12	1	49.50	15.60



Patronen Smart

3 Produkte in einem: Seife - Shampoo - Duschgel. Spitzenqualität, aus pflanzlichen Grundstoffen, ph-neutral, dermatologisch geprüft, angenehm parfümiert, biologisch abbaubar

		Stück	1	12	24
611 87 30	300 ml	1	12	79.00	63.20
			1 =	6.58	5.26



hulu Matic Organic Air-Freshener

Ideal für Toilettenräume mit 1 - 2 WC-Kabinen, Fläche ca. 30 m³. Für Dauerbetrieb oder Einschaltung mittels Sensor nur bei Licht, mit organischen, natürlichen Essenzen werden Gerüche neutralisiert und mit frischem, angenehmem Duft ersetzt
1 Dose reicht für ca. 4 - 5 Wochen

		Stück	1	6	12
612 00 00*	Airfreshener, 24 x 8,5 cm, H: 10 cm	1	1	66.50	59.85
612 00 50	Alkali-Batterien LR 20A	1	2	7.90	7.11
			1 =	3.95	3.56
612 01 06	Wirkstoffdosen "Lemon"	1	12	75.00	60.00
			1 =	6.25	5.00



Duftspender AirFreshener

Duftspender AirFreshener - das automatische und programmierbare Luftverbesserungssystem, für Räume von 50 bis 100 m³ (Volumen), Intervalle der Sprühdosis 10, 15 oder 30 Min. einstellbar

Zwei Alkali-Batterien LR20 gewährleisten eine Betriebsdauer von 12 Monaten (Lieferung ohne Batterien)

		Stück	1	6	12
612 17 00	AirFreshener, 10,5 x 10 cm, H: 26 cm	1	1	99.00	
612 18 01	Duftstoff Lemonfresh 250 ml	1	6	69.00	11.50
			1 =	11.50	
612 18 02	Duftstoff Lavendel 250 ml	1	6	69.00	



Pissoir-Hygienewürfel Piso

Verhindert Urinstein und Kalk, sorgt für offene Ablaufrohre und angenehmen Duft giftklassenfrei

		Stück	1	10	20
612 14 01	Dose à 12 Stück	1	1	40.50	32.40
				10 %	20 %



Toiletten-Reiniger

Löst Kalk, Schmutz mit Abperleffekt und angenehmen Duft

		Stück	1	3	6
600 32 10	Toilettenreiniger, Giftklasse 3, 10 l	1	1	72.00	57.60
				10 %	20 %

Hygiene / Reinigung

Pissoir-Matten

Bietet ein angenehmes Dufterlebnis für Toiletten in den Duftvariationen Mango und Ocean, die zahlreichen Noppen reduzieren Urinspritzer und setzen wohlriechenden Duft frei
Passend für alle gängigen Urinale, Wirkungsdauer bis zu 60 Tage

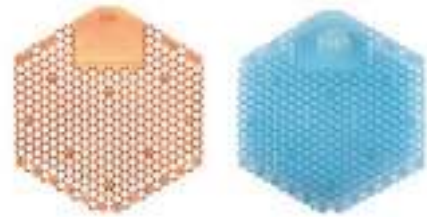

		Stück		1	10 %
612 20 00	Mango, orange	1	10	65.00	58.50
612 20 01	Ocean, blau	1	10	65.00	58.50

WC-Clip

Erfrischt die Luft bis zu 45 Tagen und sorgt für ein angenehmes Dufterlebnis für Toilette und Garderobe, umweltfreundlich und 100% recyclebar
Lässt sich ganz einfach an der Aussenseite der Toilette fixieren und passt auf sämtliche herkömmlichen Sanitäranlagen



		Stück		1	10 %
612 21 00	Mango, orange	1	12	79.00	71.10

WC-Fresh-Reiniger

Für 500 - 600 Spülungen



		Stück		1	3	6
612 10 00	WC-Fresh-Reiniger	1	12	24.90	22.41	19.92
				2.08	1.87	1.66

Feuchttuchspender WC-Sitz-Reinigung

Aus unzerbrechlichem ABS-Kunststoff, die Tücher werden im Spender luftdicht abgeschlossen, so dass ein Austrocknen verhindert wird, leichte Montage an die Wand: der Spender kann entweder mit beiliegendem doppelten Klebeband oder mit beiliegenden Schrauben an der Wand befestigt werden



		Stück		1	3	6
612 19 00	Spender 12 x 8.2 cm, H: 19 cm	1	1	19.50	15.60	10 %
612 19 01	Feuchttuch 12.5 x 15 cm (350 Stück)	1	12	124.00	99.20	20 %

Feuchttücher Seat Septil

Entfernt Bakterien und Viren auf Toilettensitzen innert Sekunden und hinterlässt eine saubere Oberfläche
Karton enthält 12 Beutel, (Beutel à 350 Feuchttücher)



		Stück		1	10 %
612 19 01	Feuchttuch 12.5 x 15 cm (350 Stück)	1	12	124.00	99.20

Handwaschbürstenset

Das praktische Handwaschbürstenset mit Wandhalterung, mit Selbstklebestreifen



		Stück		1
602 49 12	Handwaschbürstenset, 12 x 5 cm	1	1	5.20
602 49 51	Ersatz Handwaschbürste	1	1	2.70

Hygiene-Einweg-Handschuhe Latex

		Stück		1	10	30
401 78 01	Grösse M	1	100	14.90	13.41	11.92
401 78 02	Grösse L	1	100	14.90	13.41	11.92



Gummi-Handschuhe

Farben assortiert

		Stück		1	10	60
602 55 01	Grösse 6.5 S	10	1	1.60	1.44	1.28
602 55 02	Grösse 7.5 M	10	1	1.60	1.44	1.28
602 55 03	Grösse 8.5 L	10	1	1.60	1.44	1.28





Allzwecktuch

Hohe Saugkraft, weich, staubmagnetisch, kochfest bis 95°C, 38 x 40 cm

		Stück	1	6	12
602 60 00	3 Farben assortiert	1 45 1=	26.00 0.58	23.40 0.52	22.10 0.49
602 60 15	gelb	1 15 1=	9.20 0.61	8.28 0.55	7.82 0.52
602 60 42	rosa	1 15	9.20	8.28	7.82
602 60 55	grün	1 15	9.20	8.28	7.82
602 60 60	blau	1 15	9.20	8.28	7.82



Micro-Fasertuch

Grosse Reinigungskraft ohne Reinigungsmittel, waschbar bis 90°C (ohne Weichspüler), 40 x 40 cm

		Stück	1	15	30
602 61 50	hellgrün	5 1	7.30	6.57	5.84
602 61 35	rosa	5 1	7.30	6.57	5.84

1 Rolle ab
2.20



hulu Küchenrolle

100 % reine weisse Zellulose, stark saugfähig

2-lagig - günstiger und mehr auf der Rolle

		Stück	1	12	24
466 30 00	Coupons: 160, 22.6 x 25 cm	1 18 1=	49.50 2.75	44.55 2.48	39.60 2.20



Copper-Reiniger

Für Kupfer, Chromstahl und Messing

		Stück	1	6	12
600 20 07	Copper, für: Kupfer, Chromstahl, Messing, 0.75 kg	1 1	16.90	16.06	15.21
600 20 50	Copper, für: Kupfer, Inox, Messing, 5 kg	1 1	74.00	70.30	66.60
		Stück	1	12	36
600 21 07	Inox-Cleaner, für: Inox, Glaskeramik, Kupfer, Messing, 0.75 kg	1 1	16.90	16.06	15.21



Etolit Porzellanreiniger

Zur Beseitigung von Metallabrieb auf Porzellanteilen

Reinigt schonend Geschirr, Behälter, Pfannen, Besteck und Cerankochfelder

		Stück	1	12
600 24 00	Porzellanreiniger 1 l	1 1		21.50
600 24 01	Porzellanreiniger 4 x 1 l	1 4 1=		79.60 19.90



Silberpolierschaum

Reinigt Silber, mit dauerhaftem Anlaufschutz

		Stück	1	6	12
600 22 02	Dose à 200 g	1 1	14.80	14.06	13.32

Hygiene / Reinigung

AdeSectin – hält Spinnen fern

Wo Mücken und andere Insekten sich tummeln, sind auch Spinnen mit ihren Netzen aktiv. Dank AdeSectin ist dieses Problem gelöst! AdeSectin ist ein wasserlösliches, geruch- und farbloses Insektizid mit hoher Berührungs- und Frasswirkung gegen Mücken, Fliegen, Milben, Spinnen und deren Larven. AdeSectin ist gegen Witterungseinflüsse weitgehend beständig. AdeSectin bildet einen unsichtbaren, kristallinen Film, welcher der Bildung von neuen Spinnnetzen für mindestens 3 – 6 Monate wirksam vorbeugt! 1000 ml Konzentrat ergeben 20 Liter Spritzgut.

		Stück			
600 40 01	Inkl. Sprühflasche, 100 ml	1	1		39.90
600 40 02	Inkl. Sprühflasche, 250 ml	1	1		69.90
600 41 10	Inkl. Sprühflasche, 1000 ml	1	1		189.00
		Stück			1
					5 %
600 41 02	Ohne Sprühflasche, 250 ml	1	1	70.00	66.50
600 40 10	Ohne Sprühflasche, 1000 ml	1	1	189.00	179.55



3M Chromstahlreiniger

Reinigt, glänzt, schützt und pflegt

		Stück	1	6	12
600 26 06	3M Chromstahlreiniger	1	1	24.80	23.56
					5 %
					10 %
					22.32



Holz- und Edelstahlspezialpflege

Für alle empfindlichen Oberflächen und Materialien aus Holz, Kunststoff, Keramik, Messing, Bronze, Kupfer, Chrom, Edelstahl, als Cockpitpflege, und zur Farbauffrischung geeignet, antistatisch, schmutzabweisend, materialschonend, Korrosionsschutz, verhindert rasche Wiederanschmutzung

		Stück			
600 27 30	300 ml	12	1		12.80



Fensterreinigungsset

Die saubere Lösung! Bestehend aus Fensterwischer 24 cm und Microfaserhandschuh, waschbar bis 60°C (ohne Weichspüler)

		Stück			
602 74 00*	Set 2-teilig	1	2		13.80



Fenster-Reinigungsgerät

CNS, für hohe Fenster, passend zu Besenstiel 6021600

		Stück			
602 65 35	35 cm	1	1		19.80
602 65 45	45 cm	1	1		22.00
602 66 35	Ersatz-Gummi, 35 cm	1	1		4.60
602 66 45	Ersatz-Gummi, 45 cm	1	1		5.90



Scheuer-Pads

		Stück	1	20	60
601 21 00	Grob, schwarz, 16 x 21 cm, H: 1.2 cm	20	1	1.60	1.44
					10 %
					15 %
					1.36
		Stück			1
					30 %
601 22 00	Fein, grün, 15 x 20 cm	1	10	14.00	9.80



Abwasch-Pad/-Schwamm

		Stück	1	5	10
601 05 10	grün-gelb, 15 x 7 cm, H: 5 cm	1	10	15.80	15.01
601 06 00	grün-weiss, 15 x 9 cm, H: 5 cm	1	10	19.80	18.81
601 07 00	weiss-orange, 15 x 9 cm, H: 5 cm	1	10	19.80	18.81
					5 %
					10 %





Spiral-Stahlschwamm

Effiziente Reinigung, müheloses Ausspülen

		Stück	1	5	10
601 25 50	5-8 cm Ø	1	10 1 =	19.50 1.95	17.55 1.76
					15.60 1.56



Kupferlappen

Extra solid, schwere Qualität, mit Aufhänger

		Stück	1	25	50
601 26 20	20 x 17 cm	25	1	2.10	1.89
601 26 25	25 x 25 cm	25	1	4.70	4.23
					1.68
					3.76

1 Stück ab
4.20



Gläsertücher

Zwirn-Halbleinen mit 2 Aufhängern

		Stück	1	25	1
601 30 45	rot-weiss, 47 x 85 cm	1	25		105.00
601 30 65	blau-weiss, 47 x 85 cm	1	25 1 =		105.00 4.20



Gläsertücher Vileda

Geschmeidig, sehr saugfähig, staubmagnetisch, fasert nicht, kochfest, dauerhaft

		Stück	1	10	30
601 32 00	37 x 53 cm	5	1	8.50	7.65
					6.80



Abwasch-Bürste

Farben assortiert

		Stück	1	10	30
601 08 26	Grösse: 4.5 x 8 cm, 26 cm	10	1	2.00	1.90
					1.80



Bierglas-Bürste

Holzgriff, Kopf 7.5 cm Ø

		Stück	1	12	30
601 09 35	35 cm, 7.5 cm Ø	1	1	9.30	8.84
					8.37



Casserole-Bürste

Buchenholz-Stiel mit Union-Borsten

		Stück	1	12	30
601 10 30	30 cm, Grösse: 4.3 cm	1	1	12.00	11.40
					10.80



Flaschen-Bürste

Nylonborsten

		Stück	1	12	30
601 11 42	42 cm, Grösse: 4.5 x 16 cm	1	1	3.50	3.33
					3.15



Überlauf-Bürste

		Stück	1	6	12
601 14 00	22 cm, 2.5 cm Ø	1	1	3.80	3.61
					3.42



Abwasch-/ Badewannen-Bürste

		Stück	1	12	30
601 15 00	27.5 cm	1	1	5.80	5.22
					4.64

Hygiene / Reinigung

Hahnen-Bürsten

Nylonborsten

		Stück	1	6	12
601 12 10	10 mm Ø	10	1		2.60
601 12 15	15 mm Ø	10	1		2.60

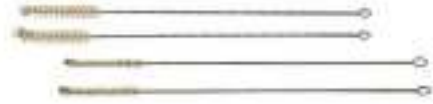

Rosshaar-Wischer

Aus Schweifhaar, für Besenstiele mit Gewinde

		Stück	1	6	12
602 15 35	35 cm	1	1	17.00	16.15
602 15 40	40 cm	1	1	21.00	19.95
602 15 50	50 cm	1	1	25.00	23.75



Besenstiele

		Stück	1	12	30
602 16 00	Stiel, Raminholz lackiert, 150 cm	1	1	4.50	4.28
602 17 00	Stiel, Buchenholz, Metallgewinde, 150 cm, 2.4 cm Ø	1	1	5.00	4.75



Reisbesen

4-bündig inkl. Akazienholzstiel

		Stück	1	6	12
602 27 00	Reisbesen	1	1	9.30	8.84



Handwischer

Schweifhaar gemischt

		Stück	1	12	30
602 18 28	28 cm	1	1	5.80	5.51



Kehrichtschaufel

Kunststoff

		Stück	1	12	30
602 20 00*		1	1	3.80	3.04



Profi-Kehrgarnitur 2-teilig

Solide Hotelqualität, Rosshaarmischung

		Stück	1	12	30
602 28 00	grau granit	1	1	8.80	8.36



Set ab
7.92

Kehrgarnitur Butler

Besenlänge: 80 - 145 cm

Kehrschaufel: 27 x 24 cm

		Stück	1	12	30
602 25 00	Kehrgarnitur Butler	1	1		30.00



Staubwedel Static Master

		Stück	1	12	30
602 71 54	54 cm	1	1		7.30
602 71 13	Mit Ausziehstiel, 113 - 200 cm	1	1		13.00



Bürsten Hygiene Programm

Hygiene-Bürsten lassen sich in kochend heissem Wasser reinigen und sind auch für die Dampfsterilisation geeignet. Bürsten bleiben hygienisch sauber, speziell für die Küche



Geschirrspülbürste

		Stück		1
602 06 00	28 x 6.5 cm	1	1	5.00 4.50
				10 %



Stielbürste

		Stück		1
602 04 40	40 cm, weiss, Borsten 0.5 mm Ø	1	1	15.00 13.50
				10 %



Mehlbesen

		Stück		1
602 07 29*	29 x 3 cm, H: 5 cm	1	1	24.00 21.60
				10 %



Besen

		Stück		1
602 10 30	30 cm, blau, Borsten 0.25 mm Ø	1	1	27.00 24.30
602 00 40	40 cm, blau, Borsten 0.25 mm Ø	1	1	37.00 33.30
				10 %



Schrubber

		Stück		1
602 02 30	Schrubber Polyester Borsten 0.5 Ø cm	1	1	17.00 15.30
602 03 00	Teleskop-Stiel Aluminium, 83 - 150 cm	1	1	15.00 13.50
				10 %
602 12 15	Glasfaserstiel, 150 cm	1	1	23.00



Handwischer/Kehrgarnitur

Polyester

		Stück		1
602 08 30	Handwischer, 30 cm, 0.25 mm Ø	1	1	11.00 9.90
				10 %
602 09 00	Kehrgarnitur	1	1	12.80 11.52
				20 %



Aufhängeschiene All-Fix

CNS, mit 3 Aufhängern, für alle Stiele geeignet

		Stück		1
602 80 00	50 cm	1	1	33.10



Plastik-Schrubber

Mit Stahlrohrstiel

		Stück		1
602 40 23	23 x 6 cm	1	1	13.00 11.70
				10 %



Hand-Fegebürsten

Polyester, spitz-rund

		Stück		1
602 39 00	18 cm	1	1	7.80

Hygiene / Reinigung

Clipper-Mop

Mop zum Auspressen, ausklinkbar

		Stück	1	12	30
				5 %	10 %
602 32 00	Mop, 50 x 16 cm	1	1	18.00	17.10
602 33 00	Klapphalter Clipper-Mop, 50 x 13 cm	1	1	58.00	55.10
		Stück			1
602 43 00	150 cm, Alustiel	1	1		13.00



Nasswisch-Mop

100 % Baumwolle

		Stück	1	10	50
				10 %	20 %
602 41 00	Mop	1	1	21.00	18.90
602 42 00	Schnellverschluss-Halter	1	1		20.00
602 43 00	150 cm, Alustiel	1	1		13.00



Schrubber mit Metallstiel

Unionsborsten

		Stück	1		1
602 49 28	21 x 7.5 cm, 145 cm	1	1		19.00
602 49 50	Ersatzbürste	1	1		14.00



Wasserschieber ohne Stiel

		Stück	1	12	30
				5 %	10 %
602 67 60	Wasserschieber, 60 cm	1	1		61.00
602 68 60	Ersatz-Gummi 60cm	1	1		17.00
602 16 00	Stiel, Raminholz lackiert, 150 cm	1	1	4.50	4.28



Bodenlappen

75% Baumwolle, verstärkt mit 25% Nylon

		Stück	1	50	100
				5 %	10 %
602 46 00	44 x 65 cm, 140 g	10	1	3.20	3.04



Putz-Eimer

Kunststoff, rechteckig (für Fegbürsten)

		Stück	1		1
602 36 12	12 l, 24.5 x 28.5 cm, H: 26.5 cm	1	1		17.50



155,70



Doppelfahreimer MidMop Comfort plus

2 x 16 Liter Behälter für Frischwasser und Schmutzwasser

		Stück	1	10 %	1
602 52 00	70 x 48 cm, H: 89 cm	1	1	173.00	155.70

Nasswisch-/Eimer-Wagen

Gestell verchromt, mit Presse

		Stück	1	10 %	1
602 45 02	2 Eimer	1	1	384.00	345.60



Staubsauger HENRY plus

Profi-Trockensauger

Das Gerät ist mit einem effizienten und langlebigen Hochleistungsmotor ausgestattet, manuelle Umschaltung von 420 auf 620 Watt möglich, Energieeffizienzklasse A, Kabelaufroll- und Schnellwechselsystem, leichte und platzsparende Aufbewahrung des Saugrohrs und der Bodendüse, Ausstattung mit Parkfunktion, enthalten: Zubehörset mit Saugrohren und trittfestem FloMax Saugschlauch, HiPro Kombidüse, Trockensaugdüse mit Bürste und umfangreichem Kleinteile-Zubehör. Kabellänge 12.5 m

		Stück	1	10 %	1
602 81 45	Rot, 35.5 x 35.5 cm, H: 41.5 cm, 9 l	1	1		310.00
602 81 65	Blau, 35.5 x 35.5 cm, H: 41.5 cm, 9 l	1	1		310.00
602 81 50	Hepa-Floh Vliesstaubeutel zu HENRY plus	1	10		25.50

Mehrzweck-Beutel

Plastik transparent, für Küche, Reisen, Abfallkörbe



		Stück	1	6	12
620 10 18	22 l, 50 x 56 cm	1	800	29.80	26.82
			100 =	3.73	3.36
620 10 33	33 l, H: 60 cm	1	600	28.00	25.20
			100 =	4.67	4.20
620 12 55	55 l, H: 77 cm	1	400	33.00	29.70
			100 =	8.25	7.43
620 11 70	70 l, H: 92 cm	1	400	50.90	45.81
620 11 77	77 l, H: 91 cm	1	600	69.00	62.10
			100 =	11.50	10.35

Kehrriechsäcke HDPE/LLDPE



		Stück	1	12	30
620 00 03	35 l, Grösse: 28 x 28 x 70 cm, my: 20	1	400	37.00	33.30
			20 =	1.85	1.67
620 00 06	60 l, Grösse: 27 x 28 x 90 cm, my: 24	1	200	33.60	30.24
			10 =	1.68	1.51
620 00 11	110 l, 33 x 37 x 110 cm, my: 25	1	200	39.50	35.55
			10 =	1.98	1.78

Kehrriechsäcke HDPE/LLDPE

Mit Städtesignet, starke, reissfeste Qualität, LD/PE



		Stück	1	12	30
620 07 03	35 l, Grösse: 28x29x70 cm, my: 50	1	400	59.90	53.91
			20 =	3.00	2.70
620 06 03	35 l, Quick-Bag, Grösse: 28x28x70 cm, my: 50	1	400	63.30	56.97
			20 =	3.17	2.85
620 07 06	60 l, Grösse: 27x28x90 cm, my: 55	1	200	58.00	52.20
			10 =	2.90	2.61
620 06 06	60 l, Quick-Bag, my: 55	1	250	63.30	56.97
			10 =	2.53	2.28
620 07 11	110 l, Grösse: 33x37x110 cm, my: 60	1	200	74.00	66.60
			10 =	3.70	3.33
620 06 11	110 l, Quick-Bag, my: 60	1	150	66.90	60.21
			10 =	4.46	4.01

Hygiene / Reinigung



Kehrichtsack-Halter

Kunststoff, mit Deckel und Fusspedal, wetterfest, leicht zu reinigen

620 09 11	110 l, 54 cm Ø, H: 88 cm	 Stück	1	1	79.00
------------------	--------------------------	---	---	---	-------



Abfalleimer

620 25 00	Rolleimer, Kunststoff, 100 l, 55 x 53 cm, H: 85 cm	 Stück	1	1	60.10
280 40 01	Push, CNS, 60 l, 40 cm Ø, H: 82 cm	 Stück	1	1	225.00 202.50



Kehrichtsackhalterung "Zacki"

Rostfreier Edelstahl mit Klemmhalterung für 110 Liter Kehrichtsäcke, einfaches Öffnen des Hygiene-Patentverschlusses mit Fusspedal

620 26 11	110 l, B x T: 45 x 53.5 cm, H: 97 cm	 Stück	1	1	373.00 298.40
------------------	--------------------------------------	---	---	---	--------------------------



Hygiene Abfallbehälter

Mit Fusspedal, Behälter aus rostfreiem Edelstahl mit Frontöffnung für einfaches Austauschen der 110 Liter Kehrichtsäcke, Deckel und Traggriff aus Polypropylen inkl. 2 Rollen 150 mm Ø

620 26 12	110 l, B x T: 45 x 53.5 cm, H: 90 cm	 Stück	1	1	594.00 475.20
------------------	--------------------------------------	---	---	---	--------------------------



Container-Einlegesäcke

Plastik transparent, mit Seitenfalten

620 21 00	800 l, 120x75 cm, H: 155 cm	 Stück	1	12	30
			1	50	49.00
					44.10 39.20



Table Top

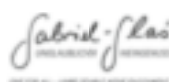



Table Top

Porzellan
Glas
Besteck
Kaffee / Tee

Eventi



NEW

Eventi

Klassisch in der Form passt Eventi in jedes Ambiente, sei es ins Bistro, das klassische Restaurant aber auch für Betriebe mit reger Beanspruchung eignet sich Eventi. Diese Porzellanlinie ist im Bankett-Bereich und auch in Kantinen ideal einsetzbar. Eventi ist formschön und widerstandsfähig, speziell für die Gastronomie konzipiert.

Table Top

Teller flach Eventi

	Stück		1
			30 %
134 020 15 15 cm Ø	6	1	2.94
134 020 18 18 cm Ø	6	1	3.36
134 020 21 21 cm Ø	6	1	3.50
134 020 23 23 cm Ø	6	1	3.92
134 020 28 28 cm Ø	6	1	6.93
134 020 31 31 cm Ø	6	1	9.45



ab
2.94

Teller tief Eventi

	Stück		1
			30 %
134 021 23 23 cm Ø	6	1	3.92
134 021 26 25.5 cm Ø	6	1	5.74
134 021 30 30 cm Ø	6	1	9.45



ab
3.92

Teller oval Eventi

	Stück		1
			30 %
134 022 23 23 x 16 cm	6	1	5.39
134 022 30 30.5 x 21 cm	6	1	9.80
134 022 35 35.5 x 25 cm	6	1	10.85



Teller extra tief Eventi

	Stück		1
			30 %
134 023 23 23 cm Ø	6	1	9.66



30%

Gourmet-Teller tief Eventi

	Stück		1
			30 %
134 024 27 27 cm Ø	6	1	14.70



Beilagen-/Salatschalen Eventi

	Stück		1
			30 %
134 025 12 12 cm Ø	6	1	3.43
134 025 14 14 cm Ø	6	1	3.92
134 025 16 16 cm Ø	6	1	4.13



Tassen und Untertassen Eventi

	Stück		1
			30 %
134 024 08 Espresso-Obertasse, 8.5 cl	12	1	2.73
134 024 12 Espresso-Untertasse, 12 cm Ø	12	1	1.89
134 024 18 Kaffee-Obertasse, 18 cl	12	1	3.85
134 024 14 Kaffee-Untertasse, 14 cm Ø	6	1	2.52
134 024 32 Cappuccino-Obertasse, 32 cl	6	1	4.62
134 024 16 Cappuccino-Untertasse, 16 cm Ø	12	1	3.08



Move



premio *Star*

NEW

Move

Spielerisch kombinieren und variieren lassen sich die verschiedenen Teile von Move. Einzeln eingesetzt oder in Kombination miteinander können Sie zum Beispiel eine Variation von Amuse-Bouches oder mehrere Desserts miteinander servieren. Move ist jung, dynamisch, flexibel. Ihrer Fantasie sind keine Grenzen gesetzt.

Table Top

Cube Move

	Stück		1
134 050 05 5 x 5 cm, H: 5 cm	6	1	4.20 2.94 30 %



30%

Schale quadratisch Move

	Stück		1
134 050 10 10 x 10 cm	6	1	5.60 3.92 30 %
134 050 12 12 x 12 cm	6	1	9.60 6.72 30 %



ab
3.92

Platte rechteckig Move

	Stück		1
134 050 26 26 x 13 cm	6	1	21.00 14.70 30 %



14.70

Platte Wings rechteckig Move

	Stück		1
134 051 26 26 x 13 cm	6	1	21.00 14.70 30 %



Holz-Tablett Serve and Move

aus edlem Walnussholz

	Stück		1
281 90 20 20 x 10 cm, H: 2 cm	1	1	31.00 24.80 20 %
281 90 28 28 x 16 cm, H: 2 cm	1	1	37.00 29.60 20 %



Schale rechteckig Move

	Stück		1
240 30 52 24 x 12 cm	1	1	13.00 9.75 25 %



Mini Teller Linea Move

Perfekt geeignet für das Präsentieren von Häppchen

	Stück		1
131 99 07 7 cm Ø	6	1	2.10 1.47 25 %
131 99 09 9 cm Ø	6	1	2.50 1.75 25 %



Meridi

premio *Star*

NEW



Meridi

Die feine Serie für das elegante Ambiente und den gepflegten Service. Aus New Bone China-Porzellan gefertigt besticht Meridi durch seine Feinheit, Formschönheit und hat den klassischen Ecu-Farbtönen von Bone-China-Porzellan. Das feine Porzellan für Ihre feinen Speisen.



ab
5.88

Teller flach Meridi

		Stück		1
				30 %
134 035 15	15 cm Ø	6	1	8.40 5.88
134 035 23	23 cm Ø	6	1	11.00 7.70
134 035 27	27 cm Ø	6	1	14.00 9.80
134 035 31	31 cm Ø	6	1	18.00 12.60
134 035 32	32 cm Ø	6	1	22.80 15.96



Teller tief Meridi

		Stück		1
				30 %
134 036 23	23 cm Ø	6	1	11.30 7.91
134 036 27	27 cm Ø	6	1	14.00 9.80



30%

Bowl Meridi

		Stück		1
				30 %
134 037 09	9 cm Ø	6	1	6.40 4.48
134 037 12	12 cm Ø	6	1	7.00 4.90
134 037 15	15 cm Ø	6	1	11.20 7.84



Tassen und Untertassen Meridi

		Stück		1
				30 %
134 038 09	Espresso-Obertasse, 9.5 cl	12	1	6.40 4.48
134 038 11	Espresso-Untertasse, 11.5 cm Ø	12	1	4.90 3.43
134 038 21	Kaffee-Obertasse, 21 cl	12	1	8.40 5.88
134 038 14	Kaffee-Untertasse, 14.5 cm Ø	6	1	5.60 3.92

Norim

premi^oStar

NEW



Norim

Norim zeichnet sich durch seine randlosen Formen aus. Die Anrichtfläche ist grösser da sich diese Linie ohne Fahne präsentiert. Norim entspricht mit seiner Coupe-Form dem heutigen Zeitgeist und hat einen leicht asiatischen Touch. Sehr vielseitig einsetzbar, ansprechend in der Form. Ihre Kreationen werden auf Norim perfekt präsentiert.

Coupeteller flach Norim

	Stück		1
			30 %
134 030 15 15 cm Ø	6 1	4.20	2.94
134 030 21 21 cm Ø	6 1	5.50	3.85
134 030 25 25.5 cm Ø	6 1	6.40	4.48
134 030 28 28 cm Ø	6 1	8.50	5.95
134 030 30 30.5 cm Ø	6 1	12.80	8.96



ab
2.94

Coupeplatte oval Norim

	Stück		1
			30 %
134 031 25 25 x 16 cm	6 1	8.50	5.95
134 031 30 30 x 21.5 cm	6 1	12.80	8.96
134 031 35 35 x 25 cm	6 1	15.60	10.92



Gourmetplatten oval Norim

	Stück		1
			30 %
132 16 22 21.5 x 11.6 cm	6 1	4.90	3.43
132 16 27 26.5 x 14.5 cm	6 1	6.80	4.76
132 16 32 32 x 16.5 cm	6 1	9.90	6.93



ab
3.43

Tassen Linea Norim

	Stück		1
			30 %
131 96 10 Espresso-Obertasse, 0.09 l	6 1	6.80	4.76
131 97 13 Espresso-Untertasse, 13 cm Ø	6 1	4.20	2.94
131 96 20 Kaffee-Obertasse, 0.2 l	6 1	7.90	5.53
131 96 27 Milchkafee-Obertasse, 0.27 l	6 1	8.80	6.16
131 97 15 Kaffee-Untertasse zu 131 96 20/131 96 27, 15 cm Ø	6 1	4.90	3.43
131 98 22 Untertasse mit Ablage zu 131 96 10/ 131 96 20/131 96 27, 22 x 13.3 cm	6 1	8.90	6.23





Steelite ist einer der Weltmarktführer für Gastronomie-Porzellan mit der grössten Porzellanproduktion in Europa und mit einer über 100-jährigen Tradition. In England gefertigt, speziell für den professionellen Einsatz konzipiert, zeichnet sich Steelite Porzellan durch seine Langlebigkeit, seine Bruchresistenz und seine sehr gute Wärmespeicherung aus. Auf hohe Funktionalität wird schon beim kreieren neuer Formen geachtet. Die Teller von Steelite sind optimal stapelbar und daher platzsparend. Die breite Palette Porzellan von Steelite kommt in vielen grossen Hotelketten weltweit erfolgreich zum Einsatz.

Neben den klassischen Linien, welche gerne im Bankettbereich eingesetzt werden, hat Steelite auch neue Trends gesetzt. Mit der Serie Craft gelang es ein gastrotaugliches Porzellan aussehen zu lassen als ob es aus der Töpferei um die Ecke käme. Die verschiedenen der Natur nachempfundenen Farben von Craft lassen sich bestens kombinieren und harmonieren perfekt. Craft widerspiegelt genau den aktuellen Zeitgeist.

Steelite produziert sehr umweltfreundlich und nachhaltig. Zusammen mit der Langlebigkeit der Produkte ergibt dies eine optimale Ökobilanz für die Produkte von Steelite. Für Unternehmen mit regem Betrieb sind die robusten, bruchresistenten Steelite Produkte ideal.

Simplicity



Simplicity - Steelite Porzellan

(G) - 5 Jahre Garantie auf Tellerkantenabsplitterung | (%) Mengenrabatte innerhalb der Marke Steelite, auch gemischt



Teller flach Simplicity Harmony

			Stück	1	60	120
					15 %	25 %
137 00 06	(G), 16,5 cm Ø	12	1	6.10	5.19	4.58
137 00 07	(G), 20 cm Ø	12	1	8.10	6.89	6.08
137 00 08	(G), 25,5 cm Ø	12	1	10.00	8.50	7.50
137 00 09	(G), 27 cm Ø	12	1	10.80	9.18	8.10
137 00 10	(G), 30 cm Ø	6	1	14.60	12.41	10.95
137 00 11	(G), 31,5 cm Ø	6	1	16.20	13.77	12.15

ab
4.35



Teller flach Simplicity Slimline

			Stück	1	60	120
					15 %	25 %
137 00 14	(G), 16 cm Ø	12	1	5.80	4.93	4.35
137 00 15	(G), 20,5 cm Ø	12	1	7.70	6.55	5.78
137 00 16	(G), 25,5 cm Ø	12	1	9.60	8.16	7.20
137 00 17	(G), 27 cm Ø	12	1	10.40	8.84	7.80
137 00 18	(G), 30 cm Ø	6	1	13.90	11.82	10.43

ab
6.60



Teller flach oval Simplicity

			Stück	1	60	120
					15 %	25 %
137 00 31	(G), 20 cm Ø	24	1	8.80	7.48	6.60
137 00 32	(G), 25,5 cm Ø	12	1	10.70	9.10	8.03
137 00 33	(G), 28 cm Ø	12	1	12.30	10.46	9.23
137 00 34	(G), 30 cm Ø	12	1	16.40	13.94	12.30
137 00 35	(G), 34 cm Ø	12	1	17.50	14.88	13.13
137 00 80	(G), 39,5 cm Ø	6	1	43.20	36.72	32.40

Teller flach oval mit Rand Simplicity



			Stück	1	60	120
					15 %	25 %
137 00 81	(G), 27 cm Ø	12	1	37.20	31.62	27.90
137 00 82	(G), 32 cm Ø	12	1	41.50	35.28	31.13



Teller tief Simplicity Harmony

			Stück	1	60	120
					15 %	25 %
137 00 12	(G), 24 cm Ø	12	1	11.90	10.12	8.93
137 00 90	(G), 27 cm Ø	6	1	15.80	13.43	11.85
137 00 13	(G), 30 cm Ø	6	1	20.00	17.00	15.00

Table Top

Taste Tulip Bowl

		Stück	1	60	120
				15 %	25 %
137 05 01	(G), 10 cm Ø	12	1	6.90	5.87
137 05 02	(G), 14 cm Ø	12	1	8.20	6.97
137 05 03	(G), 17.5 cm Ø	12	1	11.10	9.44
137 05 04	(G), 21.5 cm Ø	6	1	26.50	22.53



Suppentopf und Untertasse Simplicity Slimline

		Stück	1	60	120
				15 %	25 %
137 00 26	(G), Suppen-Obertasse, 0.28 l	12	1	8.00	6.80
137 00 62	(G), Suppen-Obertasse, 0.28 l	12	1	10.50	8.93
137 00 63	(G), Suppen-Obertasse ohne Griff, 0.28 l	12	1	7.90	6.72
137 00 54	(G), Kombi-Untertasse, 16.5 cm Ø	12	1	5.50	4.68
137 00 64	(G), Suppentopf mit Henkel inkl. Deckel, 0.425 l	6	1	20.40	17.34
137 00 65	(G), Deckel zu Suppentopf	6	1	7.00	5.95



Tassen und Untertassen Simplicity Slimline

		Stück	1	60	120
				15 %	25 %
137 00 28	(G), Espresso-Obertasse stap., 0.1 l	12	1	5.00	4.25
137 00 52	(G), Espresso-Untertasse, 12 cm Ø	12	1	3.60	3.06
137 00 29	(G), Kaffee-Obertasse stap., 0.17 l	12	1	6.00	5.10
137 00 30	(G), Kaffee-Obertasse stap., 0.2 l	12	1	6.40	5.44
137 00 46	(G), Mug, 0.24 l	12	1	6.40	5.44
137 00 47	(G), Mug, 0.28 l	12	1	6.70	5.70
137 00 53	(G), Kombi-Untertasse, 15 cm Ø	12	1	4.10	3.49



Combi Simplicity Slimline

		Stück	1	60	120
				15 %	25 %
137 00 25	(G), Schälchen, 16.5 cm Ø	6	1	5.80	4.93
137 00 27	(G), Bowl, 0.45 l	6	1	8.20	6.97
137 00 57	(G), Snack Tablett, 25.5 cm Ø	12	1	17.40	14.79



Tassen Simplicity Slimline

		Stück	1	60	120
				15 %	25 %
137 00 41	(G), Espresso-Obertasse, 0.09 l	12	1	5.00	4.25
137 00 52	(G), Espresso-Untertasse, 12 cm Ø	12	1	3.60	3.06
137 00 43	(G), Kaffee-Obertasse, 0.23 l	12	1	5.80	4.93
137 00 44	(G), Cappuccino-Obertasse, 0.34 l	12	1	7.60	6.46
137 00 45	(G), Milchkaffee-Obertasse, 0.45 l	6	1	9.10	7.74
137 00 53	(G), Kombi-Untertasse, 15 cm Ø	12	1	4.10	3.49
137 00 54	(G), Kombi-Untertasse, 16.5 cm Ø	12	1	5.50	4.68



Aroma Mug stapelbar Simplicity Slimline

		Stück	1	60	120
				15 %	25 %
137 00 59	(G), Espresso-Obertasse stap., 0.085 l	6	1	5.70	4.85
137 00 58	(G), Kaffee-Obertasse stap., 0.19 l	6	1	7.30	6.21



Taste



steelite
INTERNATIONAL



Table Top

Taste - Steelite Porzellan

Steelite Taste bringt Stil in jedes "Casual-Dining" Konzept. Die Kombinationsmöglichkeiten sind endlos und setzen der Fantasie keine Grenzen.

(G) - 5 Jahre Garantie auf Tellerkantenabsplitterung | (%) Mengenrabatte innerhalb der Marke Steelite, auch gemischt

Teller flach Taste

		Stück	1	60	120	
				15 %	25 %	
138 12 15	(G), 15.25 cm Ø	12	1	5.50	4.68	4.13
138 12 20	(G), 20.25 cm Ø	12	1	7.20	6.12	5.40
138 12 25	(G), 25.5 cm Ø	12	1	9.60	8.16	7.20
138 12 28	(G), 28 cm Ø	12	1	12.80	10.88	9.60
138 12 30	(G), 30 cm Ø	12	1	13.10	11.14	9.83



Teller tief Taste

		Stück	1	60	120	
				15 %	25 %	
138 13 21	(G), 21.5 cm Ø	12	1	11.60	9.86	8.70
138 13 25	(G), 25.25 cm Ø	12	1	13.90	11.82	10.43
138 13 29	(G), 30.5 cm Ø	12	1	17.50	14.88	13.13



Teller flach rechteckig Taste

		Stück	1	60	120	
				15 %	25 %	
138 10 16	(G), 27 x 16.8 cm	6	1	21.40	18.19	16.05
138 10 17	(G), 37 x 16.5 cm	6	1	28.90	24.57	21.68
138 10 19	(G), 33 x 19 cm	6	1	25.00	21.25	18.75
138 10 27	(G), 33 x 27 cm	6	1	33.30	28.31	24.98



Teller flach quadratisch Taste

		Stück	1	60	120	
				15 %	25 %	
138 11 27	(G), 27 x 27 cm	6	1	32.70	27.80	24.53



Schalen Taste

		Stück	1	60	120	
				15 %	25 %	
137 04 06	(G), 11.2 cm Ø	12	1	5.00	4.25	3.75
137 03 97	(G), 13.5 cm Ø	6	1	5.60	4.76	4.20
137 03 98	(G), 16.5 cm Ø	6	1	6.10	5.19	4.58
137 03 99	(G), 20.25 cm Ø	12	1	12.10	10.29	9.08



Mug Quench

		Stück	1	60	120	
				15 %	25 %	
137 00 01	(G), Espresso-Obertasse, 0.08 l	6	1	5.70	4.85	4.28
137 00 02	(G), Kaffee-Obertasse, 0.22 l	12	1	8.00	6.80	6.00
137 00 03	(G), Kaffee-Obertasse, 0.28 l	12	1	8.40	7.14	6.30
137 00 04	(G), Milch-Obertasse, 0.34 l	12	1	8.80	7.48	6.60
137 00 05	(G), Milch-Obertasse, 0.45 l	12	1	10.50	8.93	7.88



Schalen Taste

		Stück	1	60	120	
				15 %	25 %	
137 04 01	(G), Dipp Schale rund, 6.5 cm Ø	6	1	5.00	4.25	3.75
137 04 00	(G), Bol eckig, 13 x 13 cm	6	1	7.40	6.29	5.55
137 04 02	(G), Schale rechteckig, 25.5 x 13 cm	6	1	21.60	18.36	16.20





FreeStyle - Steelite Porzellan

FreeStyle ist kreativ und funktional, das neue Konzept für jede Casual-Dining-Gelegenheit. Gerichte spannend und modern zu präsentieren ohne dabei den Gebrauch aus dem Auge zu verlieren, das ist FreeStyle.

Lässig und mit viel spielerischem Charakter fusionieren kurvige Formen zu multifunktionalen Teilen.

(G) - 5 Jahre Garantie auf Tellerkantenabsplitterung | (%) Mengenrabatte innerhalb der Marke Steelite, auch gemischt



Teller flach FreeStyle

		Stück	1	60	120
138 30 16	(G), 15.5 x 13 cm	12	1	9.00	7.65
138 30 25	(G), 25 x 20.5 cm	12	1	19.90	16.92



Teller flach FreeStyle

		Stück	1	60	120
138 30 31	(G), 30.5 x 27.5 cm	12	1	28.30	24.06



Platte FreeStyle

		Stück	1	60	120
138 31 38	(G), 37.5 cm	6	1	36.90	31.37

ab
6.68



Schüsseln FreeStyle

		Stück	1	60	120
138 32 13	(G), 13 x 9.5 cm	6	1	8.90	7.57
138 32 15	(G), 15 x 12.5 cm	6	1	11.20	9.52
138 32 18	(G), 18 x 14 cm	12	1	13.40	11.39
138 32 24	(G), 24.5 x 21 cm	12	1	16.00	13.60
138 32 25	(G), 25.5 x 20 cm	6	1	20.50	17.43



Schüssel FreeStyle

		Stück	1	60	120
138 32 28	(G), 28 x 24.5 cm	12	1	17.00	14.45

Table Top



Scape - Steelite Porzellan

Scape hat sich in Form und Farbe die Natur als Vorbild genommen. Ansprechende organische Formen die dem Auge schmeicheln. Auch die unregelmässigen Oberflächen spiegeln diesen natürlichen Effekt.

(G) - 5 Jahre Garantie auf Tellerkantenabsplitterung | (%) Mengenrabatte innerhalb der Marke Steelite, auch gemischt

Coupe Teller Scape

		Stück	1	60	120	
				15 %	25 %	
137 21 30	(G), Teller flach, weiss, 20.25 cm Ø	12	1	8.00	6.80	6.00
137 21 31	(G), Teller flach, grau, 20.25 cm Ø	12	1	14.00	11.90	10.50
137 21 32	(G), Teller flach, weiss, 28.5 cm Ø	12	1	14.00	11.90	10.50
137 21 33	(G), Teller flach, weiss, 28.5 cm Ø	12	1	25.00	21.50	18.75
137 05 85	(G), Teller tief, weiss, 25 cm Ø	12	1	15.00	12.75	11.25
137 05 92	(G), Teller tief, grau, 25 cm Ø	12	1	24.00	20.40	18.00



Teller flach organisch Scape

		Stück	1	60	120	
				15 %	25 %	
137 05 84	(G), weiss, 37.5 cm Ø	6	1	42.70	36.30	32.03
137 05 91	(G), grau, 37.5 cm Ø	6	1	54.00	45.90	40.50



Schüsseln Scape

		Stück	1	60	120	
				15 %	25 %	
137 05 89	(G), weiss, 13 cm Ø	12	1	9.80	8.33	7.35
137 05 96	(G), grau, 13 cm Ø	12	1	13.30	11.31	9.98
137 05 88	(G), weiss, 18 cm Ø	12	1	14.80	12.58	11.10
137 05 95	(G), grau, 18 cm Ø	12	1	19.80	16.83	14.85



Mugs Scape

		Stück	1	60	120	
				15 %	25 %	
137 05 90	(G), weiss, 0.34 l	24	1	9.60	8.16	7.20
137 05 97	(G), grau, 0.34 l	24	1	14.90	12.67	11.18



Recency



Table Top

Regency - Steelite Porzellan

Regency verkörpert in seiner zeitlosen Klassik die Qualität einer vergangenen Epoche, von der es seinen Namen hat, Regency: 1810-1820 König Georg IV. von England

(G) - 5 Jahre Garantie auf Tellerkantenabsplitterung | (%) Mengenrabatte innerhalb der Marke Steelite, auch gemischt

Teller flach Regency

		Stück	1	60	120	
				15 %	25 %	
137 02 30	(G), 16 cm Ø	12	1	7.10	6.04	5.33
137 02 31	(G), 20 cm Ø	12	1	9.10	7.74	6.83
137 02 32	(G), 23 cm Ø	12	1	10.30	8.76	7.73
137 02 34	(G), 27 cm Ø	12	1	12.90	10.97	9.68
137 02 35	(G), 30.5 cm Ø	6	1	18.10	15.39	13.58
137 02 38	(G), 32 cm Ø	6	1	22.30	18.96	16.73



Teller tief Regency

		Stück	1	60	120	
				15 %	25 %	
137 02 36	(G), 22.3 cm Ø	12	1	10.40	8.84	7.80
137 02 62	(G), 30 cm Ø	6	1	22.50	19.13	16.88



Platten oval Regency

		Stück	1	60	120	
				15 %	25 %	
137 02 42	(G), 20.3 x 16 cm	12	1	11.10	9.44	8.33
137 02 43	(G), 28 x 22 cm	6	1	15.80	13.43	11.85
137 02 44	(G), 33 x 26 cm	6	1	22.70	19.30	17.03



Salat-/Müeslischalen Regency

		Stück	1	60	120	
				15 %	25 %	
137 02 37	(G), 16.5 cm Ø	6	1	7.50	6.38	5.63
137 02 65	(G), 20 cm Ø	6	1	22.70	19.30	17.03
137 02 77	(G), 13.5 cm Ø, Mit Rand	12	1	5.10	4.34	3.83
137 02 78	(G), 16.5 cm Ø, Mit Rand	12	1	7.50	6.38	5.63



Suppentassen und Untertasse Regency

		Stück	1	60	120	
				15 %	25 %	
137 02 66	(G), Suppen-Obertasse, 0.28 l	12	1	12.20	10.37	9.15
137 02 67	(G), Suppen-Obertasse, 0.28 l	12	1	9.30	7.91	6.98
137 02 84	(G), Kombi-Untertasse, 15.3 cm Ø	12	1	5.10	4.34	3.83



Tassen und Untertassen stapelbar Regency

		Stück	1	60	120	
				15 %	25 %	
137 02 68	(G), Espresso-Obertasse, 0.09 l	12	1	6.80	5.78	5.10
137 02 83	(G), Espresso-Untertasse, 12 cm Ø	12	1	4.70	4.00	3.53
137 02 69	(G), Kaffee-Obertasse, 0.17 l	12	1	7.40	6.29	5.55
137 02 70	(G), Milchkaffee-Obertasse, 0.21 l	12	1	7.40	6.29	5.55
137 02 84	(G), Kombi-Untertasse, 15.3 cm Ø	12	1	5.10	4.34	3.83



Vogue



Table Top

Vogue - Steelite Porzellan

Vogue steht für Chic und Glamour. Die konkave und breite Fahne der Teller verleiht diesem Porzellan aussergewöhnliche Klasse und eine Prise Extravaganz.

(G) - 5 Jahre Garantie auf Tellerkantenabsplitterung | (%) Mengenrabatte innerhalb der Marke Steelite, auch gemischt

Teller flach Vogue

		Stück	1	60	120
137 04 10	(G), 16.5 cm Ø	12	1	7.30	6.21 5.48
137 04 11	(G), 20.2 cm Ø	12	1	9.40	7.99 7.05
137 04 12	(G), 23 cm Ø	12	1	10.80	9.18 8.10
137 04 14	(G), 27 cm Ø	12	1	13.50	11.48 10.13
137 04 15	(G), 30 cm Ø	6	1	19.00	16.15 14.25
137 04 16	(G), 32 cm Ø	6	1	21.10	17.94 15.83



Teller tief Vogue

		Stück	1	60	120
137 04 37	(G), 24 cm Ø	12	1	11.50	9.78 8.63
137 04 19	(G), 27 cm Ø	6	1	18.30	15.56 13.73
137 04 38	(G), 30 cm Ø	6	1	26.00	22.10 19.50



Platten oval Vogue

		Stück	1	60	120
137 04 22	(G), 20.3 x 15.6 cm	12	1	11.60	9.86 8.70
137 04 23	(G), 28 x 22 cm	6	1	16.50	14.03 12.38
137 04 24	(G), 33 x 26 cm	6	1	23.90	20.32 17.93



Schalen Mandarin

		Stück	1	60	120
137 01 40	(G), 9.4 cm Ø, 0.13 l	6	1	5.90	5.02 4.43
137 01 41	(G), 10.3 cm Ø, 0.2 l	6	1	6.40	5.44 4.80
137 01 42	(G), 11.2 cm Ø, 0.26 l	6	1	7.10	6.04 5.33
137 01 43	(G), 12.7 cm Ø, 0.46 l	12	1	9.00	7.65 6.75
137 01 44	(G), 16 cm Ø, 0.8 l	6	1	9.80	8.33 7.35



Schalen flach

		Stück	1	60	120
137 01 47	(G), 7 cm Ø, 0.03 l	6	1	4.40	3.74 3.30
137 01 46	(G), 10.5 cm Ø, 0.09 l	6	1	4.80	4.08 3.60



Tassen und Untertassen Vogue

		Stück	1	60	120
137 02 39	(G), Espresso-Obertasse, 0.08 l	12	1	6.80	5.78 5.10
137 02 83	(G), Espresso-Untertasse, 12 cm Ø	12	1	4.70	4.00 3.53
137 02 71	(G), Kaffee-Obertasse, 0.23 l	12	1	8.00	6.80 6.00
137 02 72	(G), Milchkaffee-Obertasse, 0.34 l	12	1	10.50	8.93 7.88
137 02 61	(G), 0.24 l, Mug	12	1	8.20	6.97 6.15
137 02 40	(G), Tee-Tasse, 0.2275 l	12	1	8.00	6.80 6.00
137 02 84	(G), Kombi-Untertasse, 15.3 cm Ø	12	1	5.10	4.34 3.83





Contour



Contour



Quadro



Sheer



Neo

Table Top

Contour / Sheer / Quadro / Neo - Steelite Porzellan

Ungewöhnlich, dramatisch, faszinierend - eine neue Dimension der Speisepäsentation.

(G) - 5 Jahre Garantie auf Tellerkantenabsplitterung | (%) Mengenrabatte innerhalb der Marke Steelite, auch gemischt

Coupeteller flach Contour

		Stück	1	60	120
				15 %	25 %
137 01 25	(G), 15.3 cm Ø	12	1	7.30	6.21 5.48
137 01 26	(G), 20.3 cm Ø	12	1	9.40	7.99 7.05
137 01 09	(G), 23 cm Ø	12	1	11.80	10.03 8.85
137 01 27	(G), 25.5 cm Ø	12	1	12.20	10.37 9.15
137 01 08	(G), 28 cm Ø	12	1	18.50	15.73 13.88
137 01 10	(G), 30 cm Ø	6	1	19.90	16.92 14.93



ab
5.48

Coupeteller tief Contour

		Stück	1	60	120
				15 %	25 %
137 01 13	(G), 15.2 cm Ø	12	1	9.50	8.08 7.13
137 01 14	(G), 20.2 cm Ø	12	1	12.20	10.37 9.15
137 01 15	(G), 25.5 cm Ø	6	1	15.80	13.43 11.85
137 01 07	(G), 28 cm Ø	12	1	20.70	17.60 15.53
137 01 16	(G), 30 cm Ø	6	1	26.00	22.10 19.50



Schalen schräg Sheer

		Stück	1	60	120
				15 %	25 %
137 01 17	(G), 10.3 cm Ø	12	1	8.60	7.31 6.45
137 01 18	(G), 14.5 cm Ø	12	1	13.50	11.48 10.13
137 01 19	(G), 17.8 cm Ø	12	1	18.40	15.64 13.80
137 01 20	(G), 21.5 cm Ø	12	1	24.80	21.08 18.60
137 01 21	(G), 25.5 cm Ø	6	1	29.50	25.08 22.13



Teller schräg Sheer

		Stück	1	60	120
				15 %	25 %
137 01 12	(G), 30.5 cm Ø	6	1	34.80	29.58 26.10



Teller Quadro

		Stück	1	60	120
				15 %	25 %
137 02 85	(G), 14 x 14 cm	12	1	9.60	8.16 7.20
137 02 81	(G), 18 x 18 cm	12	1	11.30	9.61 8.48
137 02 82	(G), 28 x 28 cm	12	1	23.30	19.81 17.48
137 02 60	(G), 23 x 23 cm	12	1	14.20	12.07 10.65



Platten oval Neo

		Stück	1	60	120
				15 %	25 %
137 02 73	(G), 35.5 x 10 cm	12	1	24.80	21.08 18.60
137 02 74	(G), 35.5 x 15.3 cm	12	1	44.40	37.74 33.30
137 02 75	(G), 35.5 x 20.3 cm	6	1	48.10	40.89 36.08



Spyro



Table Top

Spyro - Steelite Porzellan

Das spiralförmige Reliefdekor verleiht dem Porzellan Dynamik wie auch Eleganz. Spyro passt in jedes Ambiente, sowohl für klassische wie auch moderne Umgebungen.

(G) - 5 Jahre Garantie auf Tellerkantenabsplitterung | (%) Mengenrabatte innerhalb der Marke Steelite, auch gemischt



Teller flach Spyro

		Stück	1	60	120
137 03 35	(G), Teller quadratisch, 28 cm Ø	6	1	24.30	18.23
137 03 15	(G), Teller rechteckig, 15.25 x 13 cm	12	1	9.40	7.05
137 02 90	(G), 16.5 cm Ø	12	1	7.90	5.93
137 02 92	(G), 23 cm Ø	12	1	11.50	8.63
137 02 93	(G), 25.5 cm Ø	12	1	12.90	9.68
137 02 94	(G), 28 cm Ø	12	1	14.30	10.73
137 02 95	(G), 30 cm Ø	12	1	20.20	15.15
137 02 96	(G), 32 cm Ø	6	1	22.50	16.88



Teller tief Spyro

		Stück	1	60	120
137 03 17	(G), 24 cm Ø	12	1	11.60	8.70
137 02 97	(G), 27 cm Ø	6	1	20.50	15.38
137 03 18	(G), 30 cm Ø	6	1	27.30	20.48



Platten oval Spyro

		Stück	1	60	120
137 03 03	(G), 20.3 x 16 cm	12	1	12.40	9.30
137 03 04	(G), 28 x 22 cm	12	1	17.50	13.13
137 03 05	(G), 33 x 26 cm	12	1	25.40	19.05



Suppentassen und Untertasse Spyro

		Stück	1	60	120
137 03 20	(G), Suppen-Obertasse, 0.285 l	12	1	13.60	10.20
137 03 21	(G), Suppen-Obertasse, 0.285 l	12	1	10.30	7.73
137 03 34	(G), Kombi-Untertasse, 15.25 cm Ø	12	1	5.70	4.28



Tassen und Untertassen stapelbar Spyro

		Stück	1	60	120
137 03 22	(G), Espresso-Obertasse, 0.09 l	12	1	7.60	5.70
137 03 33	(G), Espresso-Untertasse, 11.75 cm Ø	12	1	5.20	3.90
137 03 24	(G), Kaffee-Obertasse, 0.21 l	12	1	8.20	6.15
137 03 34	(G), Kombi-Untertasse, 15.25 cm Ø	12	1	5.70	4.28



Tassen und Untertassen Spyro

		Stück	1	60	120
137 03 00	(G), Espresso-Obertasse, 0.09 l	12	1	7.60	5.70
137 03 33	(G), Espresso-Untertasse, 11.75 cm Ø	12	1	5.20	3.90
137 03 01	(G), Kaffee-Obertasse, 0.23 l	12	1	8.90	6.68
137 03 28	(G), Milchkaffee-Obertasse, 0.34 l	12	1	11.70	8.78
137 03 16	(G), Mug, 0.34 l	24	1	12.80	9.60
137 03 34	(G), Kombi-Untertasse, 15.25 cm Ø	12	1	5.70	4.28

Craft



Table Top

Craft - Steelite Porzellan

Craft erinnert in seinem rustikalen Ausdruck an traditionelle, handwerklich hergestellte Töpferware, wie wir sie seit Jahrhunderten kennen. Jedes einzelne Porzellanstück ist von Hand dekoriert und somit ein Unikat. Craft besitzt eine Authentizität, die einzigartig ist.

(G) - 5 Jahre Garantie auf Tellerkantenabsplitterung | (%) Mengenrabatte innerhalb der Marke Steelite, auch gemischt

Teller flach Craft

		Stück	1	60 15 %	120 25 %	
138 40 27	(G), 15.5 cm Ø, terracotta	12	1	9.30	7.91	6.98
138 40 55	(G), 15.5 cm Ø, green	12	1	9.30	7.91	6.98
138 40 65	(G), 15.5 cm Ø, celadon	12	1	9.30	7.91	6.98
138 40 85	(G), 15.5 cm Ø, brown	12	1	9.30	7.91	6.98
138 41 27	(G), 20.5 cm Ø, terracotta	12	1	13.40	11.39	10.05
138 41 55	(G), 20.5 cm Ø, green	12	1	13.40	11.39	10.05
138 41 65	(G), 20.5 cm Ø, celadon	12	1	13.40	11.39	10.05
138 41 85	(G), 20.5 cm Ø, brown	12	1	13.40	11.39	10.05
138 41 95	(G), 20.5 cm Ø, grey	12	1	13.40	11.39	10.05
138 42 27	(G), 25.5 cm Ø, terracotta	12	1	20.10	17.09	15.08
138 42 55	(G), 25.5 cm Ø, green	12	1	20.10	17.09	15.08
138 42 65	(G), 25.5 cm Ø, celadon	12	1	20.10	17.09	15.08
138 42 85	(G), 25.5 cm Ø, brown	12	1	20.10	17.09	15.08
138 42 95	(G), 25.5 cm Ø, grey	12	1	20.10	17.09	15.08
137 76 55	(G), 28 cm Ø, green	12	1	25.60	21.76	19.20
137 76 65	(G), 28 cm Ø, celadon	12	1	25.60	21.76	19.20
138 43 27	(G), 30 cm Ø, terracotta	12	1	26.30	22.36	19.73
138 43 55	(G), 30 cm Ø, green	12	1	26.30	22.36	19.73
138 43 65	(G), 30 cm Ø, celadon	12	1	26.30	22.36	19.73
138 43 85	(G), 30 cm Ø, brown	12	1	26.30	22.36	19.73
138 43 95	(G), 30 cm Ø, grey	12	1	26.30	22.36	19.73

ab
6.98



Teller flach Craft

		Stück	1	60 15 %	120 25 %	
138 48 27	(G), 27 x 16.8 cm, terracotta	6	1	43.80	37.23	32.85
138 48 65	(G), 27 x 16.8 cm, celadon	6	1	43.80	37.23	32.85
138 48 85	(G), 27 x 16.8 cm, brown	6	1	43.80	37.23	32.85
138 21 55	(G), 33 x 19 cm, green	6	1	54.20	46.07	40.65
138 21 65	(G), 33 x 19 cm, celadon	6	1	54.20	46.07	40.65
138 20 65	(G), 37 x 16.5 cm, celadon	6	1	59.20	50.32	44.40
138 22 55	(G), 27 x 27 cm, green	6	1	67.00	56.95	50.25
138 22 65	(G), 27 x 27 cm, celadon	6	1	67.00	56.95	50.25
138 49 65	(G), 33 x 27 cm, celadon	6	1	68.40	58.14	51.30



Teller tief Craft

		Stück	1	60 15 %	120 25 %	
138 44 27	(G), 13 cm Ø, terracotta	12	1	17.00	14.45	12.75
138 44 65	(G), 13 cm Ø, celadon	12	1	17.00	14.45	12.75
138 44 85	(G), 13 cm Ø, brown	12	1	17.00	14.45	12.75
138 18 55	(G), 20.5 cm Ø, green	12	1	20.10	17.09	15.08
138 18 65	(G), 20.5 cm Ø, celadon	12	1	20.10	17.09	15.08
138 18 85	(G), 20.5 cm Ø, brown	12	1	20.10	17.09	15.08
138 18 95	(G), 20.5 cm Ø, grey	12	1	20.10	17.09	15.08
138 19 85	(G), 25.5 cm Ø, brown	12	1	26.60	22.61	19.95
138 19 27	(G), 25.5 cm Ø, terracotta	12	1	26.60	22.61	19.95
138 19 55	(G), 25.5 cm Ø, green	12	1	26.60	22.61	19.95
138 19 65	(G), 25.5 cm Ø, celadon	12	1	26.60	22.61	19.95
138 19 95	(G), 25.5 cm Ø, grey	12	1	26.60	22.61	19.95





Gratin-/Eierplatte oval Craft

			Stück	1	60	120
					15 %	25 %
135 20 65	(G), 20 x 11 cm, celadon	12	1	26.60	22.61	19.95
135 21 27	(G), 24.5 x 13.5 cm, terracotta	12	1	31.50	26.78	23.63
135 22 85	(G), 30.5 x 17 cm, brown	6	1	44.70	38.00	33.53
135 23 55	(G), 34 x 19 cm, green	6	1	52.80	44.88	39.60



Gratin-/Eierplatte rund Craft

			Stück	1	60	120
					15 %	25 %
135 24 27	(G), 16,5 cm Ø, terracotta	12	1	24.30	20.66	18.23
135 25 65	(G), 19 cm Ø, celadon	12	1	32.50	27.63	24.38
135 26 55	(G), 21.5 cm Ø, green	12	1	39.70	33.75	29.78
135 26 85	(G), 21.5 cm Ø, brown	12	1	39.70	33.75	29.78

Schüsseln Craft



			Stück	1	60	120
					15 %	25 %
138 45 27	(G), 13 cm Ø, terracotta	12	1	15.00	12.75	11.25
138 45 55	(G), 13 cm Ø, green	12	1	15.00	12.75	11.25
138 45 65	(G), 13 cm Ø, celadon	12	1	15.00	12.75	11.25
138 45 85	(G), 13 cm Ø, brown	12	1	15.00	12.75	11.25
138 45 95	(G), 13 cm Ø, grey	12	1	15.00	12.75	11.25
138 46 27	(G), 18 cm Ø, terracotta	12	1	22.70	19.30	17.03
138 46 55	(G), 18 cm Ø, green	12	1	22.70	19.30	17.03
138 46 65	(G), 18 cm Ø, celadon	12	1	22.70	19.30	17.03
138 46 85	(G), 18 cm Ø, brown	12	1	22.70	19.30	17.03
138 46 95	(G), 18 cm Ø, grey	12	1	22.70	19.30	17.03

Schüsseln Craft



			Stück	1	60	120
					15 %	25 %
138 47 27	(G), 12,8 cm Ø, terracotta	12	1	14.10	11.99	10.58
138 47 55	(G), 12,8 cm Ø, green	12	1	14.10	11.99	10.58
138 47 65	(G), 12,8 cm Ø, celadon	12	1	14.10	11.99	10.58
138 47 85	(G), 12,8 cm Ø, brown	12	1	14.10	11.99	10.58
138 47 95	(G), 12,8 cm Ø, grey	12	1	14.10	11.99	10.58

ab
5,55



Tassen und Untertassen Craft

			Stück	1	60	120
					15 %	25 %
138 23 55	(G), Espresso-Obertasse, 0.085 l, green	12	1	7.40	6.29	5.55
138 23 65	(G), Espresso-Obertasse, 0.085 l, celadon	12	1	7.40	6.29	5.55
138 23 85	(G), Espresso-Obertasse, 0.085 l, brown	12	1	7.40	6.29	5.55
138 23 95	(G), Espresso-Obertasse, 0.085 l, grey	12	1	7.40	6.29	5.55
138 28 55	(G), Espresso-Untertasse, 11.8 cm Ø, green	12	1	5.70	4.85	4.28
138 28 65	(G), Espresso-Untertasse, 11.8 cm Ø, celadon	12	1	5.70	4.85	4.28
138 28 85	(G), Espresso-Untertasse, 11.8 cm Ø, brown	12	1	5.70	4.85	4.28
138 28 95	(G), Espresso-Untertasse, 11.8 cm Ø, grey	12	1	5.70	4.85	4.28
138 24 55	(G), Kaffee-Obertasse, 0.23 l, green	12	1	9.80	8.33	7.35
138 24 65	(G), Kaffee-Obertasse, 0.23 l, celadon	6	1	9.80	8.33	7.35
138 24 85	(G), Kaffee-Obertasse, 0.23 l, brown	12	1	9.80	8.33	7.35
138 25 55	(G), Cappuccino-Obertasse, 0.34 l, green	12	1	14.30	12.16	10.73
138 29 55	(G), Kombi-Untertasse, 14.5 cm Ø, green	12	1	6.90	5.87	5.18
138 29 65	(G), Kombi-Untertasse, 14.5 cm Ø, celadon	12	1	6.90	5.87	5.18
138 29 85	(G), Kombi-Untertasse, 14.5 cm Ø, brown	12	1	6.90	5.87	5.18
137 90 55	(G), Mug, 0.28 l, green	12	1	15.60	13.26	11.70
137 90 65	(G), Mug, 0.28 l, celadon	12	1	15.60	13.26	11.70

Table Top

Teller flach Craft

		Stück	1	60	120
				15 %	25 %
138 40 00	(G), 15.5 cm Ø, white	12	1	9.30	7.91 6.98
138 41 00	(G), 20.5 cm Ø, white	12	1	13.40	11.39 10.05
138 42 00	(G), 25.5 cm Ø, white	12	1	20.10	17.09 15.08
138 43 00	(G), 30 cm Ø, white	12	1	26.30	22.36 19.73
137 76 00	(G), 28 cm Ø, white	12	1	25.60	21.76 19.20



ab
6.98

Teller tief Craft

		Stück	1	60	120
				15 %	25 %
138 44 00	(G), 13 cm Ø, white	12	1	17.00	14.45 12.75
138 18 00	(G), 20.5 cm Ø, white	12	1	20.10	17.09 15.08
138 19 00	(G), 25.5 cm Ø, white	12	1	26.60	22.61 19.95



Nouveau Teller tief Craft

		Stück	1	60	120
				15 %	25 %
137 98 00	(G), 27 cm Ø, white	6	1	29.80	25.33 22.35



Teller flach Craft

		Stück	1	60	120
				15 %	25 %
138 48 00	(G), 27 x 16.8 cm, white	6	1	43.80	37.23 32.85
138 21 00	(G), 33 x 19 cm, white	6	1	54.20	46.07 40.65
138 49 00	(G), 33 x 27 cm, white	6	1	68.40	58.14 51.30
138 20 00	(G), 37 x 16.5 cm, white	6	1	59.20	50.32 44.40
138 22 00	(G), 27 x 27 cm, white	6	1	67.00	56.95 50.25



Schüsseln Craft

		Stück	1	60	120
				15 %	25 %
138 45 00	(G), 13 cm Ø, white	12	1	15.00	12.75 11.25
138 46 00	(G), 18 cm Ø, white	12	1	22.70	19.30 17.03



Schüssel Craft

		Stück	1	60	120
				15 %	25 %
138 47 00	(G), 12.8 cm Ø, white	12	1	14.10	11.99 10.58



Tassen und Untertasse Craft

		Stück	1	60	120
				15 %	25 %
138 23 00	(G), Espresso-Obertasse, 0.085 l, white	12	1	7.40	6.29 5.55
138 24 00	(G), Kaffee-Obertasse, 0.23 l, white	12	1	9.80	8.33 7.35
138 25 00	(G), Cappuccino-Obertasse, 0.34 l, white	12	1	14.30	12.16 10.73
138 29 00	(G), Kombi-Untertasse, 14.5 cm Ø, white	12	1	6.90	5.87 5.18
137 90 00	(G), Mug, 0.28 l, white	12	1	15.60	13.26 11.70





Brown Dapple



Table Top

(G) - 5 Jahre Garantie auf Tellerkantenabsplitterung | (%) Mengenrabatte innerhalb der Marke Steelite, auch gemischt

Teller flach mit Fahne Brown Dapple

		Stück	1	60	120	
				15 %	25 %	
137 03 50	(G), 15.75 cm Ø	12	1	7.20	6.12	5.40
137 03 51	(G), 20.25 cm Ø	12	1	9.20	7.82	6.90
137 03 52	(G), 23 cm Ø	12	1	11.20	9.52	8.40
137 03 53	(G), 25.5 cm Ø	12	1	12.70	10.80	9.53
137 03 54	(G), 27 cm Ø	12	1	13.80	11.73	10.35



Coupeteller flach Brown Dapple

		Stück	1	60	120	
				15 %	25 %	
137 03 40	(G), 15.25 cm Ø	12	1	7.80	6.63	5.85
137 03 41	(G), 20.25 cm Ø	12	1	10.20	8.67	7.65
137 03 42	(G), 23 cm Ø	12	1	12.50	10.63	9.38
137 03 43	(G), 25.25 cm Ø	12	1	13.80	11.73	10.35
137 03 44	(G), 28 cm Ø	12	1	18.60	15.81	13.95
137 03 45	(G), 30 cm Ø	12	1	18.90	16.07	14.18



Coupeteller tief Brown Dapple

		Stück	1	60	120	
				15 %	25 %	
137 03 49	(G), 13 cm Ø	12	1	12.80	10.88	9.60
137 03 48	(G), 20.5 cm Ø	12	1	16.90	14.37	12.68
137 03 47	(G), 25.25 cm Ø	12	1	20.20	17.17	15.15
137 03 46	(G), 29 cm Ø	6	1	25.40	21.59	19.05



Teller flach rechteckig Brown Dapple

		Stück	1	60	120	
				15 %	25 %	
137 03 58	(G), 20 x 10 cm	6	1	28.80	24.48	21.60
137 03 56	(G), 27 x 16.75 cm	6	1	31.70	26.95	23.78
137 03 57	(G), 33 x 19 cm	6	1	35.50	30.18	26.63



Gratin-/Eierplatte und Suppentopf Brown Dapple

		Stück	1	60	120	
				15 %	25 %	
137 03 76	(G), Gratin-/Eierplatte, 16.5 cm Ø	12	1	17.50	14.88	13.13
137 03 77	(G), Gratin-/Eierplatte, 19 cm Ø	12	1	23.80	20.23	17.85
137 01 92	(G), Gratin-/Eierplatte, 21.5 cm Ø	12	1	29.50	25.08	22.13
137 01 93	(G), Suppentopf ohne Deckel, 0.425 l	6	1	24.80	21.08	18.60
137 01 94	(G), Deckel zu Suppentopf	6	1	9.70	8.25	7.28



Schalen Brown Dapple

		Stück	1	60	120	
				15 %	25 %	
137 03 72	(G), 11.5 cm Ø	12	1	7.10	6.04	5.33
137 03 73	(G), 14 cm Ø	12	1	7.40	6.29	5.55
137 03 74	(G), 16.5 cm Ø	12	1	8.90	7.57	6.68
137 03 75	(G), 20.25 cm Ø	12	1	17.90	15.22	13.43



Tassen und Untertassen Brown Dapple

		Stück	1	60	120	
				15 %	25 %	
137 03 60	(G), Espresso-Obertasse, 0.085 l	12	1	7.20	6.12	5.40
137 03 67	(G), Espresso-Untertasse, 12.5 cm Ø	12	1	5.30	4.51	3.98
137 03 61	(G), Kaffee-Obertasse, 0.23 l	12	1	8.40	7.14	6.30
137 03 62	(G), Cappuccino-Obertasse, 0.285 l Ø	12	1	10.60	9.01	7.95
137 03 63	(G), Milchkaffee-Obertasse, 0.35 l	12	1	11.10	9.44	8.33
137 03 65	(G), Mug, 0.285 l	12	1	10.90	9.27	8.18
137 03 66	(G), Kombi-Untertasse, 15 cm Ø	12	1	6.40	5.44	4.80





Willow - Steelite Porzellan

Fast wie wärmende Sonnenstrahlen wirkt das edle Relief das die Serie Willow schmückt. Elegante Serie für den gepflegten Service auch im Gourmet-Bereich. Und der positive Nebeneffekt, auf dem Relief sind keine Abdrücke zu sehen.

(G) - 5 Jahre Garantie auf Tellerkantenabsplitterung | (%) Mengenrabatte innerhalb der Marke Steelite, auch gemischt



Teller flach Willow

		Stück	1	60	120
139 53 16	(G), 15 cm Ø	12	1	7.80	6.63
139 53 20	(G), 20 cm Ø	12	1	10.00	8.50
139 53 23	(G), 23 cm Ø	12	1	11.50	9.78
139 53 25	(G), 25 cm Ø	12	1	12.90	10.97
139 53 27	(G), 27 cm Ø	12	1	14.30	12.16
139 53 28	(G), 28.5 cm Ø	12	1	18.50	15.73
139 53 30	(G), 30 cm Ø	12	1	19.80	16.83
					5.85
					15 %
					25 %



Accent Teller flach Willow

		Stück	1	60	120
139 53 18	(G), 18.5 cm Ø	12	1	9.70	8.25
					7.28
					15 %
					25 %

Table Top

Gourmet-Teller flach Willow

		Stück	1	60	120
				15 %	25 %
139 54 28	(G), Gourmet-Teller medium Fahne, 28.5 cm Ø	6	1	26.50	22.53 19.88
139 54 29	(G), Gourmet-Teller breite Fahne, 28.5 cm Ø	6	1	26.50	22.53 19.88



Gourmet-Coupteller Willow

		Stück	1	60	120
				15 %	25 %
139 55 28	(G), 28 cm Ø	6	1	20.50	17.43 15.38



ab
15.38

Gourmet-Coupeteller tief Willow

		Stück	1	60	120
				15 %	25 %
139 57 29	(G), Gourmet Coupe-Teller tief, 28.5 cm Ø	6	1	26.50	22.53 19.88
139 57 28	(G), Gourmet Coupe-Teller tief, 28 cm Ø	6	1	22.90	19.47 17.18



Gourmet-Teller tief Willow

		Stück	1	60	120
				15 %	25 %
139 56 28	(G), 28.5 cm Ø	6	1	26.50	22.53 19.88
139 56 31	(G), 31.5 cm Ø	6	1	27.20	23.12 20.40



Schalen Willow

		Stück	1	60	120
				15 %	25 %
139 59 10	(G), 10 cm Ø	12	1	7.50	6.38 5.63
139 59 13	(G), 13 cm Ø	12	1	9.90	8.42 7.43
139 59 16	(G), 16 cm Ø	12	1	13.10	11.14 9.83



Suppentasse und Untertasse Willow

		Stück	1	60	120
				15 %	25 %
139 58 29	(G), Suppen-Obertasse stapelbar, 0.28 l	12	1	10.20	8.67 7.65
139 58 15	(G), Kombi-Untertasse, 15.25 cm Ø	12	1	5.60	4.76 4.20



Tassen und Untertassen Willow

		Stück	1	60	120
				15 %	25 %
139 58 21	(G), Kaffee-Obertasse stap., 0.21 l	12	1	8.20	6.97 6.15
139 58 22	(G), Kaffee-Obertasse, 0.23 l	12	1	8.80	7.48 6.60
139 58 28	(G), Mug, 0.285 l	12	1	12.70	10.80 9.53
139 58 15	(G), Kombi-Untertasse, 15.25 cm Ø	12	1	5.60	4.76 4.20





Pier - Porzellan by Robert Gordon

Einzigartig, natürlich, außergewöhnlich

Ein wunderschönes, naturalistisches Porzellan mit einem aufregenden Sortiment an geprägten Tellern, Schalen und Zubehörteilen. Pier bietet eine neutrale, reaktive Glasurfarbe und ein einzigartiges Finish. Die Farbintensität wird von Stück zu Stück variieren, wodurch ein handgefertigter Look für Ihre Speisenpräsentation entsteht.



Teller flach Pier

		Stück	1	60	120	
				15 %	25 %	
139 97 01	Teller flach, 19 cm Ø	12	1	13.00	11.05	9.75
139 97 02	Teller flach, 23 cm Ø	12	1	16.80	14.28	12.60
139 97 03	Teller flach, 26.7 cm Ø	24	1	21.00	17.85	15.75



Coupeteller Pier

		Stück	1	60	120	
				15 %	25 %	
139 97 04	Coupeteller, 12.7 cm Ø	12	1	6.50	5.53	4.88
139 97 05	Coupeteller, 18.4 cm Ø	12	1	13.20	11.22	9.90
139 97 06	Coupeteller tief, 23 cm Ø	12	1	19.50	16.58	14.63
139 97 07	Coupeteller tief, 29 cm Ø	6	1	28.00	23.80	21.00



Teller flach mit Rand Pier

		Stück	1	60	120	
				15 %	25 %	
139 97 09	Teller flach mit Rand, 16.5 cm Ø, H: 2 cm	12	1	9.00	7.65	6.75
139 97 10	Teller flach mit Rand, 16.5 cm Ø, H: 4 cm	12	1	11.90	10.12	8.93



Schalen/Bowl/Mug Pier

		Stück	1	60	120	
				15 %	25 %	
139 97 16	Mini-Schale, oval, 6.7 x 6 cm	12	1	3.30	2.81	2.48
139 97 17	Mini-Schale, oval, 10 x 8.5 cm	12	1	4.20	3.57	3.15
139 97 08	Schale tief, 20 cm Ø, H: 6 cm, 100 cl	12	1	15.80	13.43	11.85
139 97 11	Mug, 9.5 cm Ø, H: 9.5 cm, 33.4 cl	12	1	8.50	7.23	6.38



Gratinformen/Ramequin Pier

		Stück	1	60	120	
				15 %	25 %	
139 97 14	Mini Ramequin, 8 cm Ø, H: 2 cm	12	1	3.50	2.98	2.63
139 97 13	Ramequin, 8.5 cm Ø, H: 5 cm, 18 cl	12	1	5.60	4.76	4.20
139 97 12	Gratinform mit Griff, 13 cm Ø, H: 3.5 cm	12	1	11.80	10.03	8.85
139 97 15	Bowl mit Griff, 10 cm Ø, H: 6 cm, 25.6 cl	12	1	8.20	6.97	6.15



porcini



liquorice

Craft Porcini/Liquorice - Steelite Porzellan

Craft erinnert in seinem rustikalen Ausdruck an traditionelle, handwerklich hergestellte Töpferware, wie wir sie seit Jahrhunderten kennen. Jedes einzelne Porzellanstück ist von Hand dekoriert und somit ein Unikat. Craft besitzt eine Authentizität, die einzigartig ist. Die neuen erdigen Farben porcini und liquorice ergänzen das erfolgreiche Programm.

(G) - 5 Jahre Garantie auf Tellerkantenabsplitterung | (%) Mengenrabatte innerhalb der Marke Steelite, auch gemischt.

Teller flach Craft

		Stück	1	60	120	
				15 %	25 %	
138 40 03	(G) 15.5 cm Ø, porcini	12	1	9.30	7.91	6.98
138 40 99	(G) 15.5 cm Ø, liquorice	12	1	9.30	7.91	6.98
138 41 03	(G) 20.5 cm Ø, porcini	12	1	13.40	11.39	10.05
138 41 99	(G) 20.5 cm Ø, liquorice	12	1	13.40	11.39	10.05
138 42 03	(G) 25.5 cm Ø, porcini	12	1	20.10	17.09	15.08
138 42 99	(G) 25.5 cm Ø, liquorice	12	1	20.10	17.09	15.08
138 43 03	(G) 30 cm Ø, porcini	12	1	26.30	22.36	19.73
138 43 99	(G) 30 cm Ø, liquorice	12	1	26.30	22.36	19.73



NEW

Teller tief Craft

		Stück	1	60	120	
				15 %	25 %	
138 18 03	(G) 21.5 cm Ø, porcini	12	1	20.10	17.09	15.08
138 18 99	(G) 21.5 cm Ø, liquorice	12	1	20.10	17.09	15.08
138 19 03	(G) 25.5 cm Ø, porcini	12	1	26.60	22.61	19.95
138 19 99	(G) 25.5 cm Ø, liquorice	12	1	26.60	22.61	19.95



Dippschale/Schüsseln Craft

		Stück	1	60	120	
				15 %	25 %	
137 97 03	(G) 6.5 cm Ø, Dippschale, porcini	12	1	10.80	9.18	8.10
137 97 99	(G) 6.5 cm Ø, Dippschale, liquorice	12	1	10.80	9.18	8.10
138 45 03	(G) 13 cm Ø, porcini	12	1	15.00	12.75	11.25
138 45 99	(G) 13 cm Ø, liquorice	12	1	15.00	12.75	11.25
138 46 03	(G) 18 cm Ø, porcini	12	1	22.70	19.30	17.03
138 46 99	(G) 18 cm Ø, liquorice	12	1	22.70	19.30	17.03



Tassen und Untertassen Craft

		Stück	1	60	120	
				15 %	25 %	
138 23 03	(G) Espr.Obertasse, 0.085 l, porcini	12	1	7.40	6.29	5.55
138 23 99	(G) Espr.Obertasse, 0.085 l, liquorice	12	1	7.40	6.29	5.55
138 28 03	(G) Espresso-Untertasse, 11.8 cm Ø, porcini	12	1	5.70	4.85	4.28
138 28 99	(G) Espresso-Untertasse, 11.8 cm Ø, liquorice	12	1	5.70	4.85	4.28
138 24 03	(G) Kaffee-Obertasse, 0.23 l, porcini	12	1	9.80	8.33	7.35
138 24 99	(G) Kaffee-Obertasse, 0.23 l, liquorice	12	1	9.80	8.33	7.35
138 29 03	(G) Kaffee-Untertasse, 14.5 cm Ø, porcini	12	1	6.90	5.87	5.18
138 29 99	(G) Kaffee-Untertasse, 14.5 cm Ø, liquorice	12	1	6.90	5.87	5.18





Koto - Steelite Porzellan

Koto ist von den antiken japanischen Tenmoku-Glasuren inspiriert. Diese wunderschönen Glasuren, welche durch Beigabe von Eisenoxyd erzeugt werden, variieren geringfügig sowohl in Bezug auf die Oberfläche wie auch in Bezug auf die Farbe von Teil zu Teil. Somit ist jedes Porzellanteil ein von Hand glasiertes Unikat.

(G) - 5 Jahre Garantie auf Tellerkantenabsplitterung | (%) Mengenrabatte innerhalb der Marke Steelite, auch gemischt



ab
10.35

Teller flach Koto

		Stück	1	60	120
				15 %	25 %
138 17 09	15.5 cm Ø, (G)	36	1	13.80	10.35
138 17 08	(G), 20.5 cm Ø	24	1	18.00	13.50
138 17 07	(G), 25.5 cm Ø	24	1	24.40	18.30
138 17 06	(G), 30 cm Ø	12	1	33.40	25.05



Teller tief Koto

		Stück	1	60	120
				15 %	25 %
138 17 11	(G), 20.5 cm Ø	24	1	28.30	21.23
138 17 10	(G), 25.5 cm Ø	12	1	34.00	25.50



Teller flach rechteckig Koto

		Stück	1	60	120
				15 %	25 %
138 17 01	(G), 27 x 16.8 cm	6	1	53.20	39.90
138 17 02	(G), 33 x 27 cm	6	1	83.10	62.33
138 17 03	(G), 37 x 16.5 cm	6	1	71.90	53.93
138 17 05	(G), 33 x 19 cm	6	1	59.70	44.78



Teller flach quadratisch Koto

		Stück	1	60	120
				15 %	25 %
138 17 04	(G), 27 x 27 cm	6	1	81.40	61.05



Schalen Koto

		Stück	1	60	120
				15 %	25 %
138 17 15	(G), 7 cm Ø	12	1	10.00	7.50
138 17 18	(G), 10.3 cm Ø	12	1	14.90	11.18
138 17 17	(G), 11.2 cm Ø	12	1	16.40	12.30
138 17 16	(G), 15.9 cm Ø	12	1	29.20	21.90
138 17 14	(G), 12.8 cm Ø	12	1	20.90	15.68
138 17 19	(G), Sake, 8.5 cl	36	1	13.00	9.75

Table Top

Teller flach Rio

		Stück	1	60	120	
				15 %	25 %	
137 40 44	(G), 15.8 cm Ø, rosa	12	1	9.10	7.74	6.83
137 40 55	(G), 15.8 cm Ø, grün	12	1	9.10	7.74	6.83
137 40 65	(G), 15.8 cm Ø, blau	12	1	9.10	7.74	6.83
137 41 55	(G), 20.3 cm Ø, grün	12	1	11.80	10.03	8.85
137 41 65	(G), 20.3 cm Ø, blau	12	1	11.80	10.03	8.85
137 42 55	(G), 23 cm Ø, grün	12	1	14.60	12.41	10.95
137 42 65	(G), 23 cm Ø, blau	12	1	14.60	12.41	10.95
137 43 55	(G), 27 cm Ø, vert	12	1	17.80	15.13	13.35
137 43 65	(G), 27 cm Ø, blau	12	1	16.50	14.03	12.38
137 44 44	(G), 30 cm Ø, rosa	6	1	24.40	20.74	18.30
137 44 65	(G), 30 cm Ø, blau	6	1	24.40	20.74	18.30



Teller tief Rio

		Stück	1	60	120	
				15 %	25 %	
137 45 65	(G), 21.5 cm Ø, blau	12	1	14.70	12.50	11.03
137 46 65	(G), 30 cm Ø, blau	6	1	30.50	25.93	22.88



Suppentassen und Untertasse Rio

		Stück	1	60	120	
				15 %	25 %	
137 50 44	(G), Bouillon-Obertasse, 0.285 l, rosa	12	1	12.40	10.54	9.30
137 53 44	(G), Kombi-Untertasse, 16.5 cm Ø, rosa	12	1	8.70	7.40	6.53



Schalen Rio

		Stück	1	60	120	
				15 %	25 %	
137 47 65	(G), 14 cm Ø, blau	6	1	9.10	7.74	6.83
137 47 44	(G), 14 cm Ø, rosa	6	1	9.10	7.74	6.83
137 47 15	(G), 14 cm Ø, gelb	6	1	9.10	7.74	6.83
137 48 55	(G), 16.5 cm Ø, grün	6	1	9.70	8.25	7.28
137 48 65	(G), 16.5 cm Ø, blau	6	1	9.70	8.25	7.28

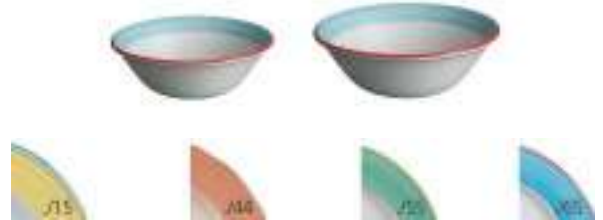

Tassen und Untertassen stapelbar Rio

		Stück	1	60	120	
				15 %	25 %	
137 55 65	(G), Espresso-Obertasse, 0.1 l, blau	12	1	7.10	6.04	5.33
137 51 44	(G), Espresso-Untertasse, 11.8 cm Ø, rosa	12	1	5.50	4.68	4.13
137 56 65	(G), Kaffee-Obertasse, 0.17 l, blau	12	1	9.20	7.82	6.90
137 57 65	(G), Kaffee-Obertasse, 0.2 l, blau	12	1	10.80	9.18	8.10
137 52 44	(G), Kombi-Untertasse, 14.5 cm Ø, rosa	12	1	6.70	5.70	5.03
137 63 65	(G), Mug, 0.28 l, blau	12	1	12.90	10.97	9.68
137 53 44	(G), Kombi-Untertasse, 16.5 cm Ø, rosa	12	1	8.70	7.40	6.53





Maxim



Table Top

Maxim - Seltmann Weiden Porzellan

(%) Mengenrabatte innerhalb der Marke Seltmann, auch gemischt

Teller flach Maxim

	Stück	1	60	120
			10 %	20 %
117 254 24 Teller flach, 17 cm Ø	6	7.90	7.11	6.32
117 254 25 Teller flach, 21.5 cm Ø	6	11.10	9.99	8.88
117 254 26 Teller flach, 23 cm Ø	6	13.10	11.79	10.48
117 254 27 Teller flach, 26 cm Ø	6	15.50	13.95	12.40
117 254 28 Teller flach, 28 cm Ø	6	21.80	19.62	17.44
117 254 29 Teller flach, 30 cm Ø	6	26.80	24.12	21.44
117 254 30 Teller flach, 33 cm Ø	6	36.20	32.58	28.96



ab
6,32

Teller tief Maxim

	Stück	1	60	120
			10 %	20 %
117 254 50 Teller tief, 19 cm Ø	6	11.10	9.99	8.88
117 254 31 Teller tief, 23 cm Ø	6	14.10	12.69	11.28
117 254 52 Teller tief, 27 cm Ø	2	18.10	16.29	14.48
117 254 51 Teller tief, 30 cm Ø	2	24.90	22.41	19.92



Platte oval Maxim

	Stück	1	60	120
			10 %	20 %
117 254 63 Platte oval, 25 x 18 cm	2	22.20	19.98	17.76
117 254 64 Platte oval, 28 x 21 cm	2	27.40	24.66	21.92
117 254 65 Platte oval, 31 x 24 cm	2	31.40	28.26	25.12
117 254 66 Platte oval, 35 x 28 cm	2	35.70	32.13	28.56



Suppentasse und Untertasse Maxim

	Stück	1	60	120
			10 %	20 %
117 254 36 Suppen-Obertasse, 0.27 l	6	13.20	11.88	10.56
117 254 96 Kombi-Untertasse, 16.5 cm Ø	6	6.00	5.40	4.80



Salat-/Müeslischale Maxim

	Stück	1	60	120
			10 %	20 %
117 254 43 13 cm Ø, 0.3 l	4	7.20	6.48	5.76
117 254 44 15 cm Ø, 0.47 l	2	9.60	8.64	7.68
117 254 45 18 cm Ø, 0.8 l	2	13.70	12.33	10.96
117 254 48 21 cm Ø, 1.3 l	2	17.50	15.75	14.00
117 254 49 24 cm Ø, 2 l	2	20.30	18.27	16.24



Eventbowl oval Maxim

	Stück	1	60	120
			10 %	20 %
117 254 42 18 x 12.5 cm, 0.38 l	2	12.00	10.80	9.60



Tassen und Untertassen Tulpe Maxim



	Stück	1	60	120
117 254 87 Espresso-Obertasse, 0.09 l	6	1	7.80	7.02
117 254 88 Espresso-Untertasse, 13.5 cm Ø	6	1	5.20	4.68
117 254 94 Kaffee-Obertasse, 0.18 l	6	1	8.90	8.01
117 254 95 Kaffee-Obertasse, 0.22 l	6	1	10.70	9.63
117 254 85 Milchkaffee-Obertasse, 0.37 l	6	1	12.30	11.07
117 254 96 Kombi-Untertasse, 16.5 cm Ø	6	1	6.00	5.40
117 255 04 Mug mit Henkel, 0.28 l	6	1	10.30	9.27



Kaffee- und Teekrug Maxim

	Stück	1	60	120
117 254 68 Kaffeekrug, 0.38 l	2	1	28.80	25.92
117 254 71 Teekrug, 0.55 l	2	1	33.80	30.42
117 255 12 Teesieb	2	1	10.50	9.45
117 269 47 Teesieb Bowl, 0.18 l	6	1	8.90	8.01



Crémier Maxim

	Stück	1	60	120
117 254 81 Crémier, 0.3 dl	12	1	8.80	7.92
117 254 82 Crémier, 1.5 dl	6	1	14.20	12.78
117 254 83 Crémier, 2.5 dl	6	1	19.20	17.28



Accessoires Maxim

	Stück	1	60	120
117 255 11 Partylöffel, 15 x 5 cm, 0.8 dl	6	1	9.10	8.19
117 254 46 Dipschälchen klein, 8.5 cm Ø, 0.4 dl	6	1	7.60	6.84
117 254 47 Dipschälchen gross, 11 cm Ø, 0.9 dl	6	1	9.10	8.19
117 254 54 Buttersauciere, 1.5 dl	4	1	14.20	12.78
117 254 53 Sauciere, 4.5 dl	2	1	34.60	31.14



Table Top



Maxim Organic - Seltmann Weiden Porzellan

(%) Mengenrabatte innerhalb der Marke Seltmann, auch gemischt

Gourmetteller flach Maxim Organic

	Stück	1	60	120	
			10 %	20 %	
117 254 32 Gourmetteller flach, 19 x 16 cm	6	1	7.40	6.66	5.92
117 254 33 Gourmetteller flach, 24 x 20 cm	6	1	9.80	8.82	7.84
117 254 34 Gourmetteller flach, 29.5 x 24 cm	6	1	17.30	15.57	13.84
117 254 35 Gourmetteller flach, 34 x 28 cm	2	1	29.00	26.10	23.20



Gourmetteller tief Maxim Organic

	Stück	1	60	120	
			10 %	20 %	
117 254 37 Gourmetschale tief, 8 x 7 cm	6	1	7.60	6.84	6.08
117 254 38 Gourmetschale tief, 12 x 10 cm	6	1	8.70	7.83	6.96
117 254 39 Gourmetschale tief, 16 x 14 cm	4	1	9.40	8.46	7.52
117 254 40 Gourmetschale tief, 20 x 16 cm	2	1	9.80	8.82	7.84
117 254 41 Gourmetschale tief, 26 x 22 cm	2	1	22.20	19.98	17.76



ab
6.08



Maxim Coup Fine Dining



Table Top

Maxim Coup Fine Dining - Seltmann Weiden Porzellan

(%) Mengenrabatte innerhalb der Marke Seltmann, auch gemischt

Coupeteller flach Maxim Coup Fine Dining

	Stück	1	60	120
			10 %	20 %
117 324 10 Coupeteller flach, 16.5 cm Ø	6	1	9.30	8.37 7.44
117 324 09 Coupeteller flach, 21.5 cm Ø	6	1	13.10	11.79 10.48
117 324 08 Coupeteller flach, 26 cm Ø	6	1	16.80	15.12 13.44
117 324 07 Coupeteller flach, 28 cm Ø	6	1	22.20	19.98 17.76
117 324 06 Coupeteller flach, 30 cm Ø	6	1	27.40	24.66 21.92



Coupeteller tief Maxim Coup Fine Dining

	Stück	1	60	120
			10 %	20 %
117 324 15 Coupeteller tief, 14.5 cm Ø	6	1	9.30	8.37 7.44
117 324 14 Coupeteller tief, 20 cm Ø	6	1	15.20	13.68 12.16
117 324 13 Coupeteller tief, 23 cm Ø	6	1	17.50	15.75 14.00
117 324 12 Coupeteller tief, 26 cm Ø	6	1	19.60	17.64 15.68
117 324 11 Coupeteller tief, 28 cm Ø	6	1	27.10	24.39 21.68



Coupeplatte oval Maxim Coup Fine Dining

	Stück	1	60	120
			10 %	20 %
117 343 45 Coupeplatte oval, 33 x 18 cm	2	1	30.10	27.09 24.08
117 324 16 Coupeplatte oval, 40 x 25.5 cm	2	1	67.10	60.39 53.68
117 324 17 Coupeplatte oval, 43 x 19 cm	2	1	63.90	57.51 51.12



Coupeplatte oval Maxim Coup Fine Dining

	Stück	1	60	120
			10 %	20 %
117 343 47 Coupeplatte oval, 35 x 11 cm	2	1	24.00	21.60 19.20
117 324 18 Coupeplatte oval, 44 x 14 cm	2	1	60.60	54.54 48.48
117 343 49 Setplatte oval, 44 x 14 cm	2	1	60.60	54.54 48.48



Bowls Maxim Coup Fine Dining

	Stück	1	60	120
			10 %	20 %
117 343 51 8 cm Ø, 0.18 l, H: 6 cm	6	1	9.40	8.46 7.52
117 343 52 9.5 cm Ø, 0.21 l, H: 5 cm	6	1	11.30	10.17 9.04





Diamant



Table Top

Diamant - Seltmann Weiden Porzellan

(%) Mengenrabatte innerhalb der Marke Seltmann, auch gemischt

Teller flach Diamant

	Stück	1	60	120
			10 %	20 %
117 086 83 Teller flach, 17 cm Ø	6	1	8.50	7.65 6.80
117 086 86 Teller flach, 19 cm Ø	6	1	9.10	8.19 7.28
117 086 94 Teller flach, 22.5 cm Ø	6	1	13.10	11.79 10.48
117 086 89 Teller flach, 26 cm Ø	6	1	15.50	13.95 12.40
117 086 97 Teller flach, 29 cm Ø	6	1	23.00	20.70 18.40
117 087 00 Teller flach, 31.5 cm Ø	6	1	31.10	27.99 24.88
117 086 92 Teller flach, 33 cm Ø	6	1	36.20	32.58 28.96



TOP

Teller tief Diamant

	Stück	1	60	120
			10 %	20 %
117 145 78 Teller tief, 17 cm Ø	6	1	8.60	7.74 6.88
117 087 19 Teller tief, 20 cm Ø	6	1	11.10	9.99 8.88
117 087 03 Teller tief, 23 cm Ø	6	1	14.10	12.69 11.28
117 087 23 Teller tief, 27 cm Ø	2	1	18.10	16.29 14.48
117 087 21 Teller tief, 30 cm Ø	2	1	24.90	22.41 19.92



Platte oval Diamant

	Stück	1	60	120
			10 %	20 %
117 087 39 Platte oval, 33 x 26 cm	2	1	31.50	28.35 25.20
117 087 41 Platte oval, 38 x 31 cm	2	1	38.90	35.01 31.12



Teller tief oval Diamant

	Stück	1	60	120
			10 %	20 %
117 087 26 Teller tief oval, 24 x 19 cm	2	1	22.20	19.98 17.76
117 087 28 Teller tief oval, 28 x 22.4 cm	2	1	26.90	24.21 21.52



Eventteller flach Diamant

	Stück	1	60	120
			10 %	20 %
117 145 81 Eventteller flach, 22 cm Ø	6	1	8.80	7.92 7.04
117 145 82 Eventteller flach, 25 cm Ø	6	1	12.80	11.52 10.24



Eventteller tief Diamant

	Stück	1	60	120
			10 %	20 %
117 145 80 Eventteller tief, 26 cm Ø	2	1	17.60	15.84 14.08



Suppentasse und Untertasse Diamant



		Stück	1	60	120	
				10 %	20 %	
117 087 07	Suppen-Obertasse, 0.27 l	6	1	13.20	11.88	10.56
117 087 70	Kombi-Untertasse, 17 cm Ø	6	1	5.40	4.86	4.32

Salat-/Müeslischale Diamant



		Stück	1	60	120	
				10 %	20 %	
117 087 09	15 cm Ø, 0.17 l	4	1	9.60	8.64	7.68
117 087 11	18 cm Ø, 0.36 l	2	1	13.70	12.33	10.96
117 087 13	23 cm Ø, 0.72 l	2	1	17.60	15.84	14.08
117 087 15	26 cm Ø, 1 l	2	1	20.30	18.27	16.24
117 087 17	29 cm Ø, 1.35 l	2	1	24.30	21.87	19.44

Eventschale schräg Diamant



		Stück	1	60	120	
				10 %	20 %	
117 145 83	10 cm Ø, 0.03 l	6	1	13.70	12.33	10.96
117 145 84	14 cm Ø, 0.05 l	6	1	16.80	15.12	13.44
117 145 85	18 cm Ø, 0.13 l	4	1	22.90	20.61	18.32
117 145 86	22 cm Ø, 0.29 l	2	1	36.20	32.58	28.96

Crémier Diamant



		Stück	1	60	120	
				10 %	20 %	
117 087 46	Crémier, 0.3 dl	12	1	8.80	7.92	7.04
117 087 47	Crémier, 1.5 dl	6	1	14.20	12.78	11.36
117 087 48	Crémier, 2.5 dl	6	1	19.20	17.28	15.36
117 175 53	Crémier, 5 dl	6	1	24.80	22.32	19.84

Tassen und Untertassen stapelbar Diamant



		Stück	1	60	120	
				10 %	20 %	
117 087 64	Espresso-Obertasse, 0.08 l	12	1	7.80	7.02	6.24
117 087 62	Espresso-Untertasse, 13.5 cm Ø	12	1	4.60	4.14	3.68
117 087 68	Milchkaffee-Obertasse, 0.18 l	6	1	8.90	8.01	7.12
117 087 76	Milchkaffee-Obertasse, 0.25 l	6	1	11.60	10.44	9.28
117 087 80	Milchkaffee-Obertasse, 0.32 l	6	1	10.40	9.36	8.32
117 087 70	Kombi-Untertasse, 17 cm Ø	6	1	5.40	4.86	4.32
117 087 82	Mug mit Henkel, 0.28 l	6	1	10.30	9.27	8.24

Teetassen und Untertassen Diamant



		Stück	1	60	120	
				10 %	20 %	
117 087 54	Tee-Obertasse, 0.21 l	6	1	10.70	9.63	8.56
117 145 92	Tee-Obertasse, 0.25 l	6	1	10.40	9.36	8.32
117 145 93	Tee-Obertasse, 0.32 l	6	1	11.00	9.90	8.80
117 087 70	Kombi-Untertasse, 17 cm Ø	6	1	5.40	4.86	4.32

Tassen und Untertassen Tulpe Diamant



		Stück	1	60	120	
				10 %	20 %	
117 087 61	Espresso-Obertasse, 0.09 l	12	1	7.80	7.02	6.24
117 087 59	Espresso-Untertasse, 13.5 cm Ø	12	1	4.60	4.14	3.68
117 087 58	Kaffee-Obertasse, 0.23 l	6	1	10.70	9.63	8.56
117 087 51	Milchkaffee-Obertasse, 0.37 l	6	1	12.30	11.07	9.84
117 087 70	Kombi-Untertasse, 17 cm Ø	6	1	5.40	4.86	4.32
117 087 83	Mug mit Henkel, 0.3 l	6	1	11.60	10.44	9.28



Bild: Seltmann GmbH Weiden



Bild: Seltmann GmbH Weiden

Die im Jahre 1910 gegründete »Porzellanfabriken Christian Seltmann« hat sich durch Übernahme der »Königlich privilegierte Porzellanfabrik Tettau« mit den 1990 eingegliederten vier spezialisierten Porzellanmanufakturen und einer Kunstabteilung zu einer Unternehmensgruppe entwickelt, die bis heute als Familienunternehmen geführt wird.

In 5 Werken wird mit ca. 1000 Mitarbeitern erlesenes Porzellan für die Bereiche Haushalt, Hotellerie / Gastronomie, Sozial- und Systemgastronomie gefertigt.

Mit der Übernahme der Porzellanfabrik Königlich Tettau und den Manufakturen verfügt die Seltmann Gruppe über 250 Jahre Erfahrung in der Porzellanherstellung.

Dabei erfüllt das Porzellan der Firmengruppe höchste internationale Ansprüche an Design, Funktionalität, Langlebigkeit und Exklusivität. Gerade diese Produkt-Eigenschaften sind es, deren hoher Qualitäts-Standard ausschliesslich am Standort Deutschland gehalten werden kann.

Dieser Philosophie treu, hält die Seltmann Gruppe – als einer von wenigen Porzellanherstellern – sämtliche Produktionsstandorte in Deutschland.

Um die qualitäts- und arbeitsplatzsichernde Unternehmensausrichtung glaubhaft und nachhaltig zu kommunizieren, hat Seltmann Weiden ein eigenes »Made in Germany«-Siegel entwickelt.





HOTEL

Meran



Table Top

Meran - Seltmann Weiden Porzellan

(%) Mengenrabatte innerhalb der Marke Seltmann, auch gemischt

Teller flach Meran

	Stück	1	60	120	
			10 %	20 %	
116 908 15 Teller flach, 15 cm Ø	6	1	4.40	3.96	3.52
111 531 80 Teller flach, 17 cm Ø	6	1	4.90	4.41	3.92
111 540 13 Teller flach, 20 cm Ø	6	1	5.10	4.59	4.08
111 548 54 Teller flach, 23 cm Ø	6	1	6.70	6.03	5.36
111 551 88 Teller flach, 26 cm Ø	6	1	7.90	7.11	6.32
111 560 22 Teller flach, 28 cm Ø	6	1	11.00	9.90	8.80
111 570 14 Teller flach, 30 cm Ø	6	1	18.40	16.56	14.72
111 578 57 Teller flach, 33 cm Ø	6	1	25.50	22.95	20.40



ab
3,52

Teller tief Meran

	Stück	1	60	120	
			10 %	20 %	
111 665 89 Teller tief, 19 cm Ø	6	1	5.80	5.22	4.64
111 609 41 Teller tief, 23 cm Ø	6	1	7.50	6.75	6.00



Pastateller Meran

	Stück	1	60	120	
			10 %	20 %	
111 673 88 Pastateller, 23 cm Ø	6	1	11.10	9.99	8.88
111 670 68 Pastateller, 27 cm Ø	2	1	17.70	15.93	14.16
111 677 30 Pastateller, 30 cm Ø	2	1	24.40	21.96	19.52



Pastateller oval Meran

	Stück	1	60	120	
			10 %	20 %	
111 662 67 Pastateller oval, 32 x 26 cm	1	1	38.30	34.47	30.64



Platte oval Meran

	Stück	1	60	120	
			10 %	20 %	
111 715 54 Platte oval, 25 x 16 cm	2	1	16.20	14.58	12.96
111 720 56 Platte oval, 28 x 21 cm	2	1	26.40	23.76	21.12
111 725 47 Platte oval, 31 x 23 cm	2	1	30.10	27.09	24.08
111 730 49 Platte oval, 35 x 26 cm	2	1	34.20	30.78	27.36



Suppentasse und Untertasse Meran

	Stück	1	60	120	
			10 %	20 %	
111 811 54 Kombi-Untertasse, 16 cm Ø	6	1	4.60	4.14	3.68
111 622 64 Suppentasse, 0.28 l	6	1	10.40	9.36	8.32



Bowl Meran Steak & More

	Stück	1	60	120	
			10 %	20 %	
110 044 28 Bowl, 13 cm Ø, 0.6 l	6	1	11.20	10.08	8.96



ab
4.96



Salat-/Müeslischalen Meran

		Stück	1	60	120
				10 %	20 %
111 629 49	13 cm Ø, 0.24 l	6	1	6.20	4.96
111 636 10	15 cm Ø, 0.35 l	4	1	7.70	6.16
111 641 23	16 cm Ø, 0.5 l	2	1	8.10	6.48
111 646 37	20 cm Ø, 1 l	2	1	13.40	10.72
111 652 87	23 cm Ø, 1.5 l	2	1	18.70	14.96
111 657 78	25 cm Ø, 1.9 l	2	1	24.10	19.28



Tassen und Untertassen Meran

		Stück	1	60	120
				10 %	20 %
111 772 13	Espresso-Obertasse, 0.09 l	6	1	7.90	6.32
111 778 55	Espresso-Untertasse, 12 cm Ø	6	1	5.20	4.16
111 844 84	Cappuccino-Obertasse, 0.25 l	6	1	8.80	7.04
111 839 83	Kombi-Untertasse, 14.7 cm Ø	6	1	5.80	4.64
111 851 56	Milchkaffee-Obertasse, 0.35 l	6	1	9.80	7.84
116 588 37	Kombi-Untertasse, 16 cm Ø	6	1	6.50	5.20



Tassen und Untertassen Meran

		Stück	1	60	120
				10 %	20 %
111 785 16	Espresso-Obertasse, 0.09 l	6	1	7.90	6.32
111 778 55	Espresso-Untertasse, 12 cm Ø	6	1	5.20	4.16
111 883 18	Kaffee-Obertasse, 0.18 l	6	1	8.10	6.48
111 869 71	Cappuccino-Obertasse, 0.22 l	6	1	8.80	7.04
111 839 83	Kombi-Untertasse, 14.7 cm Ø	6	1	5.80	4.64
116 588 38	Cappuccino-Obertasse, 0.29 l	6	1	9.30	7.44
111 893 12	Milchkaffee-Obertasse, 0.37 l	6	1	9.80	7.84
116 588 37	Kombi-Untertasse, 16 cm Ø	6	1	6.50	5.20
111 854 87	Jumbo-Obertasse, 0.5 l	6	1	11.90	9.52
111 853 27	Jumbo-Untertasse, 19 cm Ø	6	1	6.60	5.28
111 859 89	Tasse ohne Henkel, 0.5 l	6	1	10.40	8.32



Tassen und Untertassen stapelbar Meran

		Stück	1	60	120
				10 %	20 %
111 798 38	Espresso-Obertasse hoch, 0.09 l	12	1	5.20	4.16
111 806 62	Espresso-Obertasse, 0.09 l	12	1	5.20	4.16
111 795 19	Espresso-Untertasse, 13.6 cm Ø	12	1	3.90	3.12
111 818 15	Kaffee-Obertasse, 0.18 l	6	1	5.80	4.64
111 874 84	Kaffee-Obertasse, 0.2 l	6	1	5.80	4.64
111 832 98	Cappuccino-Obertasse, 0.25 l	6	1	8.40	6.72
111 898 12	Mug stapelbar, 0.25 l	6	1	8.40	6.72
111 811 54	Kombi-Untertasse, 16 cm Ø	6	1	4.60	3.68



Mugs Meran

		Stück	1	60	120
				10 %	20 %
111 899 72	Mug stapelbar, 0.25 l	6	1	6.50	5.20
111 901 32	Mug stapelbar, 0.3 l	6	1	6.70	5.36



Tassen und Untertassen Meran Steak & More

		Stück	1	60	120
				10 %	20 %
110 044 27	Espresso-Obertasse, 0.09 l	6	1	7.90	6.32
110 044 26	Espresso-Untertasse, 12.7 cm Ø	6	1	5.20	4.16
110 044 25	Kaffee-Obertasse, 0.2 l	6	1	8.80	7.04
110 044 23	Cappuccino-Obertasse, 0.25 l	6	1	9.80	7.84
110 044 24	Kombi-Untertasse, 16 cm Ø	6	1	5.80	4.64
110 044 29	Mug Diva, 0.35 l	6	1	9.80	7.84
110 044 21	Kombi-Untertasse, 17.5 cm	6	1	6.50	5.20



Meran Steak & More



Meran Steak & More- Seltmann Weiden Porzellan

(%) Mengenrabatte innerhalb der Marke Seltmann, auch gemischt



Teller flach Meran Steak & More

		Stück	1	60	120	
				10 %	20 %	
111 585 40	Teller flach, 15.5 cm Ø	6	1	8.10	7.29	6.48
111 590 20	Teller flach, 17.5 cm Ø	6	1	8.90	8.01	7.12
116 183 97	Teller flach, 21.5 cm Ø	6	1	11.50	10.35	9.20
116 185 86	Teller flach, 25.5 cm Ø	6	1	13.40	12.06	10.72
116 187 75	Teller flach, 29 cm Ø	6	1	19.90	17.91	15.92



Teller tief Meran Steak & More

		Stück	1	60	120	
				10 %	20 %	
110 044 16	Teller tief, 14.5 cm Ø	6	1	8.10	7.29	6.48
110 044 17	Teller tief, 23 cm Ø	6	1	12.50	11.25	10.00
116 189 64	Teller tief, 29 cm Ø	6	1	24.70	22.23	19.76



Teller flach oval Meran Steak & More

		Stück	1	60	120	
				10 %	20 %	
110 044 14	Teller flach oval, 21 x 19 cm	6	1	12.30	11.07	9.84
111 604 60	Teller flach oval, 25 x 23 cm	6	1	13.40	12.06	10.72
111 599 80	Teller flach oval, 27 x 24.5 cm	6	1	15.50	13.95	12.40
111 595 00	Teller flach oval, 29 x 28 cm	6	1	20.90	18.81	16.72
110 044 15	Teller flach oval, 34 x 30 cm	2	1	26.40	23.76	21.12



Fitnesssteller Meran Steak & More

		Stück	1	60	120	
				10 %	20 %	
116 594 39	Fitnesssteller 2 geteilt, 34 x 30 cm	2	1	29.50	26.55	23.60
117 059 25	Fitnesssteller 4 geteilt, 34 x 30 cm	2	1	29.50	26.55	23.60



Platte oval tief Meran Steak & More

		Stück	1	60	120	
				10 %	20 %	
117 089 48	Platte tief oval, 18.5 x 12 cm	2	1	11.70	10.53	9.36
117 089 47	Platte tief oval, 23.5 x 15 cm	2	1	15.40	13.86	12.32



Bowls oval Meran Steak & More

		Stück	1	60	120	
				10 %	20 %	
117 222 08	9 x 6.5 cm, 0.05 l	6	1	7.00	6.30	5.60
117 222 13	12 x 9.5 cm, 0.18 l	6	1	8.30	7.47	6.64



Bowls oval Meran Steak & More

		Stück	1	60	120	
				10 %	20 %	
110 044 18	16 x 13.5 cm, 0.42 l	4	1	10.30	9.27	8.24
110 044 19	21 x 18 cm, 1 l	2	1	19.10	17.19	15.28
110 044 20	25.5 x 21.5 cm, 1.9 l	2	1	29.00	26.10	23.20

Table Top

Seltmann
Weiden

HOTEL



Meran Organic - Seltmann Weiden Porzellan

(%) Mengenrabatte innerhalb der Marke Seltmann, auch gemischt

Gourmetteller flach Meran Organic

		Stück	1	60	120
				10 %	20 %
117 253 20	Gourmetteller flach, 19 x 16.5 cm	6	1	7.80	7.02 6.24
117 253 21	Gourmetteller flach, 24 x 19.5 cm	6	1	10.30	9.27 8.24
117 253 22	Gourmetteller flach, 29.5 x 23.6 cm	6	1	18.20	16.38 14.56
117 253 23	Gourmetteller flach, 34 x 28.5 cm	2	1	30.60	27.54 24.48



Gourmetschale tief Meran Organic

		Stück	1	60	120
				10 %	20 %
117 253 24	Gourmetschale tief, 8,5 x 7 cm	6	1	8.00	7.20 6.40
117 253 25	Gourmetschale tief, 12 x 10 cm	6	1	9.20	8.28 7.36
117 253 26	Gourmetschale tief, 16 x 14 cm	4	1	9.80	8.82 7.84
117 253 27	Gourmetschale tief, 20 x 16 cm	2	1	10.30	9.27 8.24
117 253 28	Gourmetschale tief, 26 x 22 cm	2	1	23.50	21.15 18.80



Bowl Meran Steak & More

		Stück	1	60	120
				10 %	20 %
110 044 28	Bowl, 13 cm Ø, 0,6 l	6	1	11.20	10.08 8.96





Coup Fine Dining



Table Top

Coup Fine Dining - Seltmann Weiden Porzellan

(%) Mengenrabatte innerhalb der Marke Seltmann, auch gemischt

Coupeteller flach Coup Fine Dining

	Stück	1	60	120
			10 %	20 %
117 294 66 Coupeteller flach, 16.5 cm Ø	6	1	9.30	8.37 7.44
117 294 67 Coupeteller flach, 21.5 cm Ø	6	1	13.10	11.79 10.48
117 294 68 Coupeteller flach, 26 cm Ø	6	1	16.80	15.12 13.44
117 294 69 Coupeteller flach, 28 cm Ø	6	1	22.20	19.98 17.76
117 294 70 Coupeteller flach, 30 cm Ø	6	1	27.40	24.66 21.92



Coupeteller tief Coup Fine Dining

	Stück	1	60	120
			10 %	20 %
117 294 71 Coupeteller tief, 14.5 cm Ø	6	1	9.30	8.37 7.44
117 294 72 Coupeteller tief, 20 cm Ø	6	1	15.20	13.68 12.16
117 294 73 Coupeteller tief, 23 cm Ø	6	1	17.50	15.75 14.00
117 294 74 Coupeteller tief, 26 cm Ø	6	1	19.60	17.64 15.68
117 294 75 Coupeteller tief, 28 cm Ø	4	1	27.10	24.39 21.68



Coupeplatte oval Coup Fine Dining

	Stück	1	60	120
			10 %	20 %
117 337 89 Coupeplatte oval, 33 x 18 cm	2	1	30.10	27.09 24.08
117 294 77 Coupeplatte oval, 40 x 25.5 cm	2	1	67.10	60.39 53.68
117 294 78 Coupeplatte oval, 43 x 19 cm	2	1	63.90	57.51 51.12



Coupeplatte oval Coup Fine Dining

	Stück	1	60	120
			10 %	20 %
117 337 88 Coupeplatte oval, 35 x 11 cm	2	1	24.00	21.60 19.20
117 294 79 Coupeplatte oval, 44 x 14 cm	2	1	60.60	54.54 48.48
117 326 30 Setplatte oval, 44 x 14 cm	2	1	60.60	54.54 48.48



Bowls Coup Fine Dining

	Stück	1	60	120
			10 %	20 %
117 326 31 8 cm Ø, 0.18 l, H: 6 cm	6	1	9.40	8.46 7.52
117 326 32 9.5 cm Ø, 0.21 l, H: 5 cm	6	1	11.30	10.17 9.04





Savoy



Table Top

Savoy - Seltmann Weiden Porzellan

(%) Mengenrabatte innerhalb der Marke Seltmann, auch gemischt

Teller flach Savoy

	Stück	1	60	120
			10 %	20 %
114 963 07 Teller flach, 16 cm Ø	6	1	9.30	8.37 7.44
114 963 85 Teller flach, 18 cm Ø	6	1	9.90	8.91 7.92
114 965 41 Teller flach, 21 cm Ø	6	1	12.90	11.61 10.32
114 966 97 Teller flach, 23 cm Ø	6	1	15.40	13.86 12.32
114 968 53 Teller flach, 26 cm Ø	6	1	18.10	16.29 14.48
114 970 09 Teller flach, 28 cm Ø	6	1	25.40	22.86 20.32
114 971 65 Teller flach, 30 cm Ø	6	1	31.30	28.17 25.04
114 973 21 Teller flach, 33 cm Ø	6	1	42.40	38.16 33.92
115 011 43 Teller flach, 34 cm Ø	2	1	44.70	40.23 35.76



Gourmetteller tief Savoy

	Stück	1	60	120
			10 %	20 %
115 008 31 Gourmetteller tief, 12 cm Ø	6	1	9.30	8.37 7.44
115 006 75 Gourmetteller tief, 16 cm Ø	6	1	11.20	10.08 8.96
115 009 87 Gourmetteller tief, 18 cm Ø	6	1	12.90	11.61 10.32
115 010 65 Gourmetteller tief, 21 cm Ø	6	1	16.50	14.85 13.20
115 005 19 Gourmetteller tief, 27 cm Ø	2	1	21.10	18.99 16.88
115 003 63 Gourmetteller tief, 30 cm Ø	2	1	29.10	26.19 23.28



Teller tief Savoy

	Stück	1	60	120
			10 %	20 %
115 001 68 Teller tief, 19 cm Ø	6	1	12.90	11.61 10.32
114 974 77 Teller tief, 23 cm Ø	6	1	16.50	14.85 13.20



Platte oval Savoy

	Stück	1	60	120
			10 %	20 %
115 043 02 Platte oval, 24 x 17 cm	2	1	26.10	23.49 20.88
115 044 58 Platte oval, 28 x 19 cm	2	1	32.20	28.98 25.76
115 046 14 Platte oval, 32 x 22 cm	2	1	36.90	33.21 29.52
115 047 70 Platte oval, 36 x 25.5 cm	2	1	41.80	37.62 33.44



Platte eckig Savoy

	Stück	1	60	120
			10 %	20 %
115 036 78 Platte eckig, 16 x 12 cm	2	1	18.80	16.92 15.04
115 038 34 Platte eckig, 23 x 14 cm	2	1	27.80	25.02 22.24
115 039 90 Platte eckig, 30 x 14 cm	2	1	33.70	30.33 26.96
115 041 46 Platte eckig, 36 x 14 cm	2	1	42.40	38.16 33.92



Suppentasse und Untertasse Savoy

	Stück	1	60	120
			10 %	20 %
114 977 89 Suppen-Obertasse, 0.27 l	6	1	15.40	13.86 12.32
114 976 33 Kombi-Untertasse, 16.5 cm Ø	6	1	6.30	5.67 5.04



ab
6.72



Schalen Savoy

		Stück	1	60	120	
				10 %	20 %	
114 979 06	12 cm Ø, 0.26 l	6	1	8.40	7.56	6.72
114 980 62	14 cm Ø, 0.35 l	4	1	11.20	10.08	8.96
114 982 18	17 cm Ø, 0.72 l	2	1	15.90	14.31	12.72
114 986 08	20 cm Ø, 1.27 l	2	1	20.50	18.45	16.40
114 991 54	24 cm Ø, 1.85 l	2	1	28.40	25.56	22.72

Schalen eckig Savoy



		Stück	1	60	120	
				10 %	20 %	
114 984 91	9 x 9 cm, 0.06 l	6	1	8.90	8.01	7.12
114 987 64	11 x 11 cm, 0.18 l	6	1	10.90	9.81	8.72
114 993 10	14 x 14 cm, 0.29 l	6	1	18.80	16.92	15.04
114 994 66	17.5 x 17.5 cm, 0.52 l	2	1	24.30	21.87	19.44
114 996 22	22 x 22 cm, 1 l	2	1	42.20	37.98	33.76
114 997 78	25.5 x 25.5 cm, 1.53 l	2	1	47.20	42.48	37.76



Eventbowl oval Savoy

		Stück	1	60	120	
				10 %	20 %	
116 973 23	18 x 12.5 cm, 0.35 l	4	1	14.10	12.69	11.28



Crémier Savoy

		Stück	1	60	120	
				10 %	20 %	
115 068 37	Crémier, 0.3 dl	12	1	10.30	9.27	8.24
115 069 54	Crémier, 1.5 dl	6	1	16.70	15.03	13.36
115 070 71	Crémier, 2.5 dl	6	1	22.40	20.16	17.92
115 071 88	Crémier, 5 dl	6	1	29.10	26.19	23.28



Tassen und Untertassen stapelbar Savoy

		Stück	1	60	120	
				10 %	20 %	
115 085 14	Espresso-Obertasse, 0.09 l	12	1	9.00	8.10	7.20
115 083 58	Espresso-Untertasse, 14.5 cm Ø	12	1	6.00	5.40	4.80
115 087 87	Kaffee-Obertasse, 0.18 l	6	1	10.30	9.27	8.24
115 096 06	Milchkaffee-Obertasse, 0.36 l	6	1	13.70	12.33	10.96
115 086 31	Kombi-Untertasse, 16 cm Ø	6	1	7.00	6.30	5.60
115 097 23	Mug mit Henkel, 0.25 l	6	1	11.90	10.71	9.52



Tassen und Untertassen Kelch Savoy

		Stück	1	60	120	
				10 %	20 %	
115 082 41	Espresso-Obertasse, 0.09 l	12	1	9.00	8.10	7.20
115 080 85	Espresso-Untertasse, 14.5 cm Ø	12	1	5.30	4.77	4.24
115 079 68	Kaffee-Obertasse, 0.18 l	6	1	10.30	9.27	8.24
115 093 33	Cappuccino-Obertasse, 0.22 l Ø	6	1	13.70	12.33	10.96
115 076 95	Milchkaffee-Obertasse, 0.37 l	6	1	13.70	12.33	10.96
115 086 31	Kombi-Untertasse, 16 cm Ø	6	1	7.00	6.30	5.60



Accessoires Savoy

		Stück	1	60	120	
				10 %	20 %	
115 103 47	Partylöffel, 15 x 5 cm, 0.9 dl	6	1	10.80	9.72	8.64
114 983 74	Dipschälchen schräg, 8.5 cm Ø, 0.4 dl	6	1	8.90	8.01	7.12
114 988 81	Dipschälchen schräg, 11 cm Ø, 0.9 dl	6	1	10.80	9.72	8.64
115 026 25	Buttersauciere, 1.5 dl	4	1	16.70	15.03	13.36
115 017 67	Sauciere, 3.5 dl	2	1	40.30	36.27	32.24



Mandarin



Mandarin - Seltmann Weiden Porzellan

(%) Mengenrabatte innerhalb der Marke Seltmann, auch gemischt



Teller flach Mandarin

		Stück	1	60	120
				10 %	20 %
116 812 10	Teller flach, 16 cm Ø	6	1	9.10	7.28
116 812 11	Teller flach, 23 cm Ø	6	1	15.00	12.00
116 817 51	Teller flach, 26 cm Ø	6	1	17.40	13.92
116 812 12	Teller flach, 28 cm Ø	6	1	24.70	19.76
116 812 13	Teller flach, 30 cm Ø	6	1	30.20	24.16



Teller flach oval Mandarin

		Stück	1	60	120
				10 %	20 %
116 812 14	Teller flach oval, 18 x 16 cm	6	1	9.50	7.60
116 812 15	Teller flach oval, 24 x 21.5 cm	6	1	12.50	10.00
116 812 16	Teller flach oval, 30 x 27 cm	6	1	24.70	19.76
116 812 17	Teller flach oval, 34 x 31 cm	6	1	30.20	24.16
116 817 52	Teller flach oval, 38 x 34 cm	2	1	41.00	32.80



Teller tief oval Mandarin

		Stück	1	60	120
				10 %	20 %
116 812 18	Teller tief oval, 25 x 23.4 cm	6	1	16.80	13.44



Gourmetteller tief Mandarin

		Stück	1	60	120
				10 %	20 %
116 812 20	Gourmetteller tief, 23 cm Ø	6	1	16.60	13.28
116 817 61	Gourmetteller tief, 27 cm Ø	2	1	20.40	16.32
116 812 19	Gourmetteller tief, 30 cm Ø	2	1	25.20	20.16

ab
16,32



Pastateller tief Mandarin

		Stück	1	60	120
				10 %	20 %
117 228 93	Pastateller tief, 26.5 cm Ø	6	1	20.40	16.32



Platten oval Mandarin

		Stück	1	60	120
				10 %	20 %
116 837 68	Platte oval, 28 x 21 cm	2	1	31.20	24.96
116 812 21	Platte oval, 31 x 23 cm	2	1	35.50	28.40
116 812 22	Platte oval, 35 x 26 cm	2	1	40.40	32.32



Suppentasse und Untertassen Mandarin

		Stück	1	60	120
				10 %	20 %
116 811 77	Suppentasse, 0.27 l	6	1	15.00	12.00
116 839 07	Kombi-Untertasse, 16 cm Ø	6	1	6.10	4.88
116 839 08	Kombi-Untertasse oval, 18 x 16 cm	6	1	7.10	5.68

Table Top

Schalen oval Mandarin

		Stück	1	60	120	
				10 %	20 %	
116 831 69	15 x 14 cm, 0.2 l	6	1	8.20	7.38	6.56
116 831 70	17 x 15.5 cm, 0.3 l	4	1	10.90	9.81	8.72
116 817 59	20 x 18.5 cm, 0.45 l	2	1	15.20	13.68	12.16
116 817 60	24 x 22 cm, 0.75 l	2	1	19.80	17.82	15.84
116 837 64	27 x 25 cm, 1.25 l	2	1	20.60	18.54	16.48



Salat-/Müeslischalen Mandarin

		Stück	1	60	120	
				10 %	20 %	
116 831 66	14 cm Ø, 0.15 l	4	1	7.30	6.57	5.84
116 831 67	21 cm Ø, 0.4 l	2	1	15.20	13.68	12.16
116 831 68	28 cm Ø, 0.85 l	2	1	20.50	18.45	16.40



Tassen und Untertassen konisch Mandarin

		Stück	1	60	120	
				10 %	20 %	
116 812 25	Espresso-Obertasse, 0.09 l	12	1	8.70	7.83	6.96
116 813 36	Kaffee-Obertasse, 0.18 l	6	1	10.00	9.00	8.00
116 812 26	Kaffee-Obertasse, 0.25 l	6	1	12.10	10.89	9.68
116 813 37	Milchkaffee-Obertasse, 0.37 l	6	1	13.20	11.88	10.56
116 813 46	Mug mit Henkel, 0.28 l	6	1	11.50	10.35	9.20



Tassen und Untertassen stapelbar Mandarin

		Stück	1	60	120	
				10 %	20 %	
116 813 39	Espresso-Obertasse, 0.09 l	12	1	8.70	7.83	6.96
116 812 27	Espresso-Untertasse, 13.7 cm Ø	12	1	5.70	5.13	4.56
116 817 62	Espresso-Untertasse oval, 15.5 x 14 cm	6	1	6.40	5.76	5.12
116 813 42	Kaffee-Obertasse, 0.18 l	6	1	9.10	8.19	7.28
116 812 31	Milchkaffee-Obertasse, 0.25 l	6	1	13.20	11.88	10.56
116 812 32	Mug mit Henkel, 0.28 l	6	1	11.50	10.35	9.20
116 812 30	Kombi-Untertasse oval, 18 x 16 cm	6	1	7.10	6.39	5.68
116 812 29	Kombi-Untertasse, 16 cm Ø	6	1	6.80	6.12	5.44



Kaffee- und Teekrug Mandarin

		Stück	1	60	120	
				10 %	20 %	
116 813 19	Kaffeekrug, 0.35 l	2	1	32.50	29.25	26.00
116 813 20	Teekrug, 0.45 l	2	1	38.10	34.29	30.48
116 860 21	Teesieb Finum	2	1	13.00	11.70	10.40
116 860 22	Teesiebablagebehälter, 8 cm Ø	6	1	10.00	9.00	8.00



Crémier Mandarin

		Stück	1	60	120	
				10 %	20 %	
116 813 26	Crémier, 1.5 dl	6	1	16.20	14.58	12.96
116 812 24	Crémier, 2.5 dl	6	1	21.60	19.44	17.28



Accessoires Mandarin

		Stück	1	60	120	
				10 %	20 %	
116 813 08	Buttertopf, 5,5 cm Ø, 0.4 dl	2	1	6.30	5.67	5.04
116 813 09	Buttersauciere, 1.5 dl	4	1	16.20	14.58	12.96
116 813 06	Sauciere, 5 dl	2	1	39.00	35.10	31.20





No Limits



Table Top

No Limits - Seltmann Weiden Porzellan

(%) Mengenrabatte innerhalb der Marke Seltmann, auch gemischt

Gourmetteller eckig flach No Limits

	Stück	1	60	120
			10 %	20 %
117 172 79 Gourmetteller flach, 24 x 12 cm	1	1	9.40	8.46 7.52
117 172 80 Gourmetteller flach, 24 x 24 cm	6	1	13.50	12.15 10.80
117 172 81 Gourmetteller flach, 36 x 12 cm	1	1	22.10	19.89 17.68
117 172 82 Gourmetteller flach, 36 x 24 cm	2	1	30.90	27.81 24.72



ab
7,52

Gourmetteller eckig tief No Limits

	Stück	1	60	120
			10 %	20 %
117 184 25 Gourmetteller tief, 24 x 12 cm	2	1	9.40	8.46 7.52
117 172 83 Gourmetteller tief, 24 x 24 cm	6	1	13.50	12.15 10.80



Schalen rund No Limits

	Stück	1	60	120
			10 %	20 %
117 108 73 Schale, 13 cm Ø, 0.35 l, H: 4 cm	1	1	13.90	12.51 11.12
117 108 69 Schale, 13 cm Ø, 0.75 l, H: 8 cm	1	1	15.30	13.77 12.24
117 108 74 Schale, 18 cm Ø, 0.65 l, H: 4 cm	1	1	20.30	18.27 16.24
117 108 70 Schale, 18 cm Ø, 1.5 l, H: 8 cm	1	1	21.70	19.53 17.36
117 108 75 Schale, 20 cm Ø, 0.8 l, H: 4 cm	1	1	21.20	19.08 16.96
117 108 71 Schale, 20 cm Ø, 1.9 l, H: 8 cm	1	1	23.20	20.88 18.56
117 108 76 Schale, 24 cm Ø, 1.7 l, H: 4 cm	1	1	29.00	26.10 23.20
117 108 72 Schale, 24 cm Ø, 2.75 l, H: 8 cm	1	1	31.90	28.71 25.52



Schalen eckig No Limits

	Stück	1	60	120
			10 %	20 %
117 115 96 Schale, 11 x 11 cm, 0.25 l, H: 4 cm	1	1	16.00	14.40 12.80
117 115 92 Schale, 11 x 11 cm, 0.6 l, H: 8 cm	1	1	17.40	15.66 13.92
117 115 94 Schale, 23 x 23 cm, 1.3 l, H: 4 cm	1	1	34.80	31.32 27.84
117 108 77 Schale, 23 x 23 cm, 3.25 l, H: 8 cm	1	1	38.80	34.92 31.04
117 115 95 Schale, 23 x 11 cm, 0.55 l, H: 4 cm	1	1	25.00	22.50 20.00
117 115 91 Schale, 23 x 11 cm, 1.45 l, H: 8 cm	1	1	26.40	23.76 21.12
117 115 93 Schale, 35 x 11 cm, 2.2 l, H: 8 cm	1	1	36.50	32.85 29.20
117 117 03 Schale, 35 x 23 cm, 5 l, H: 8 cm	1	1	61.00	54.90 48.80



Platten/Teller rund No Limits

Können als Deckel zu Schalen rund verwendet werden

	Stück	1	60	120
			10 %	20 %
117 114 16 Platte/Teller flach, 14 cm Ø	1	1	12.40	11.16 9.92
117 114 17 Platte/Teller flach, 19 cm Ø	1	1	19.10	17.19 15.28
117 108 91 Platte/Teller flach, 21 cm Ø	1	1	20.00	18.00 16.00
117 114 28 Platte/Teller flach, 25 cm Ø	1	1	27.60	24.84 22.08



Platten/Teller eckig No Limits

Können als Deckel zu Schalen eckig verwendet werden

	Stück	1	60	120
			10 %	20 %
117 184 24 Platte/Teller flach, 9 x 9 cm	6	1	5.60	5.04 4.48
117 115 98 Platte/Teller flach, 12 x 12 cm	1	1	6.70	6.03 5.36
117 108 92 Platte/Teller flach, 24 x 24 cm	1	1	26.10	23.49 20.88
117 115 97 Platte/Teller flach, 24 x 12 cm	1	1	19.40	17.46 15.52
117 115 99 Platte/Teller flach, 36 x 12 cm	1	1	26.10	23.49 20.88
117 117 04 Platte/Teller flach, 36 x 24 cm	1	1	36.50	32.85 29.20





reddot award 2016



AWARD FOR DESIGN EXCELLENCE
NORWEGIAN DESIGN COUNCIL

Die Werkstätten von Figgjo liegen in idyllischer Landschaft im gleichnamigen Ort Figgjo im Süden Norwegens. Und dieser Landschaft wird Sorge getragen. Figgjo produziert sehr ökologisch, benutzt nur umweltfreundliche Materialien und reinigt sogar die Luft, welche die Werkstätten verlässt.

Figgjo Porzellan wird nur für die Gastronomie hergestellt. Es ist besonders hart und widerstandsfähig und hält härtester Beanspruchung stand. Figgjo besticht nicht nur durch Qualität, sondern auch durch unverkennbares Design. Immer wieder hat Figgjo neue Trends im Table Top gesetzt und wurde dafür schon mehrfach mit dem reddot design award und dem Award for Design Excellence ausgezeichnet.

Figgjo zeichnet sich auch durch Flexibilität aus. Bereits ab 48 Stück können Sie Ihr Porzellan nach Ihren Vorstellungen dekorieren lassen, sei es mit Ihrem Logo, einer speziellen Farbe oder einem eigenen Dekor. Die Möglichkeiten sind fast unbegrenzt. Wer auf gutes Design, Qualität und Nachhaltigkeit Wert legt, ist bei Figgjo genau richtig.

Table Top



Classic - Figgjo Porzellan

Zeitlos, unaufgeregt und praktisch, das ist Classic von Figgjo. Die Fahne des Tellers ist im Verhältnis zum Spiegel relativ schmal und ergibt eine optimale Anrichtfläche. Optisch ansprechend, harmonisch geformt und durch und durch praktisch.

(G) - 5 Jahre Garantie auf Tellerkantenabsplitterung | (%) Mengenrabatte innerhalb der Marke Figgjo, auch gemischt

Teller flach Classic

		Stück	1	60	120	
				10 %	20 %	
137 08 20	(G), Teller flach, 17 cm Ø	6	1	8.40	7.56	6.72
137 08 21	(G), Teller flach, 21 cm Ø	6	1	11.60	10.44	9.28
137 08 22	(G), Teller flach, 24 cm Ø	6	1	13.50	12.15	10.80
137 08 23	(G), Teller flach, 26.5 cm Ø	6	1	16.50	14.85	13.20
137 08 24	(G), Teller flach, 30 cm Ø	6	1	20.10	18.09	16.08



ab
6.72

Teller tief Classic

		Stück	1	60	120	
				10 %	20 %	
137 08 39	(G), Teller tief, 21 cm Ø	6	1	13.50	12.15	10.80
137 08 26	(G), Teller tief, 24 cm Ø	6	1	14.60	13.14	11.68



Tassen Classic

		Stück	1	60	120	
				10 %	20 %	
137 08 42	Espresso-Obertasse, 0.1 l	6	1	11.70	10.53	9.36
137 08 73	(G), Espresso-Untertasse, 12.5 cm Ø	6	1	9.30	8.37	7.44
137 08 43	Kaffee-Obertasse, 0.22 l	6	1	12.00	10.80	9.60
137 08 44	Cappuccino-Obertasse, 0.3 l	6	1	13.20	11.88	10.56
137 08 74	(G), Kombi-Untertasse, 14.5 cm Ø	6	1	10.00	9.00	8.00



Mug

		Stück	1	60	120	
				10 %	20 %	
137 09 54	4.0, Mug	6	1	21.50	19.35	17.20





Schüsseln / Schalen rund

		Stück	1	60	120
				10 %	20 %
137 06 08	6 cm Ø, H: 3.4 cm, 4 cl	6	1	11.50	10.35 9.20
137 06 27	7.8 cm Ø, H: 4.2 cm, 10 cl	6	1	12.70	11.43 10.16
137 06 10	9.5 cm Ø, H: 4.8 cm, 17 cl	6	1	13.70	12.33 10.96
137 06 11	11.5 cm Ø, H: 5.6 cm, 30 cl	6	1	14.40	12.96 11.52
137 06 09	12 cm Ø, H: 8 cm, 45 cl	6	1	15.60	14.04 12.48
137 06 13	14 cm Ø, H: 7 cm, 0.5 l	6	1	23.40	21.06 18.72
137 06 28	18.5 cm Ø, H: 7.5 cm, 1.1 l	6	1	41.20	37.08 32.96
137 06 15	22.5 cm Ø, H: 8.6 cm, 2.0 l	6	1	57.50	51.75 46.00



Schalen rund

		Stück	1	60	120
				10 %	20 %
137 08 65	12 cm Ø, H: 6 cm, 50 cl	6	1	18.80	16.92 15.04
137 08 66	17.5 cm Ø, H: 7.5 cm, 1.4 l	6	1	32.00	28.80 25.60
137 08 67	22.5 cm Ø, H: 9 cm, 2.8 l	5	1	49.30	44.37 39.44



Schüssel stapelbar

		Stück	1	60	120
				10 %	20 %
137 08 48	6 cm Ø, H: 2.2 cm, 3 cl	6	1	10.00	9.00 8.00
137 08 49	8 cm Ø, H: 3.6 cm, 8 cl	6	1	12.00	10.80 9.60
137 08 50	10 cm Ø, H: 4.5 cm, 18 cl	6	1	13.40	12.06 10.72
137 08 51	12 cm Ø, H: 5 cm, 28 cl	6	1	14.90	13.41 11.92
137 08 52	14.5 cm Ø, H: 6.5 cm, 0.5 l	6	1	16.60	14.94 13.28
137 08 53	17 cm Ø, H: 7.5 cm, 0.8 l	6	1	18.10	16.29 14.48
137 08 54	21 cm Ø, H: 8.2 cm, 1.5 l	6	1	23.90	21.51 19.12
137 08 55	24 cm Ø, H: 8.8 cm, 2.3 l	6	1	35.20	31.68 28.16
137 08 56	27.5 cm Ø, H: 9.4 cm, 3.3 l	6	1	52.50	47.25 42.00
137 08 59	35.5 cm Ø, H: 10.5 cm, 6 l	1	1	79.80	71.82 63.84



Schüsseln Ellipse

		Stück	1	60	120
				10 %	20 %
137 07 67	19.5 x 14 cm, H: 6.5 cm, 40 cl	6	1	33.00	29.70 26.40
137 07 66	21.5 x 15 cm, H: 7.5 cm, 60 cl	6	1	34.70	31.23 27.76



Teller Ellipse

		Stück	1	60	120
				10 %	20 %
137 11 87	(G), Teller mit Vertiefung, 24 x 17 cm	6	1	28.10	25.29 22.48
137 11 88	(G), Teller flach, 24 x 17 cm	6	1	28.10	25.29 22.48
137 11 97	(G), Teller flach, 29.5 x 20.5 cm	6	1	36.60	32.94 29.28
137 11 89	(G), Teller flach, 34.5 x 24 cm	6	1	46.40	41.76 37.12
137 11 90	(G), Teller flach, 39 x 27 cm	3	1	63.50	57.15 50.80
137 11 98	(G), Platte, 44.5 x 31.2 cm	1	1	86.30	77.67 69.04
137 11 92	(G), Teller mit Vertiefung, 29.5 x 20.5 cm	6	1	36.60	32.94 29.28

Porzellan mit eigenem Dekor oder Signet ab 48 Stk



Table Top



Europa - Figgjo Porzellan

Die flache, breite Fahne verleiht Figgjo Europa das klassische und elegante Aussehen. Durch die ästhetische und unaufdringliche Form ist Figgjo Europa sowohl in klassischen wie in modernen Betrieben beliebt.

(G) - 5 Jahre Garantie auf Tellerkantenabsplitterung | (%) Mengenrabatte innerhalb der Marke Figgjo, auch gemischt

Teller flach Europa

		Stück	1	60	120	
				10 %	20 %	
137 06 00	(G), Teller flach, 14,5 cm Ø	6	1	11.10	9.99	8.88
137 06 01	(G), Teller flach, 17 cm Ø	6	1	11.30	10.17	9.04
137 06 02	(G), Teller flach, 21 cm Ø	6	1	15.50	13.95	12.40
137 06 03	(G), Teller flach, 24 cm Ø	6	1	19.90	17.91	15.92
137 06 04	(G), Teller flach, 27 cm Ø	6	1	22.70	20.43	18.16
137 06 05	(G), Teller flach, 30 cm Ø	6	1	25.60	23.04	20.48
137 06 06	(G), Teller flach, 32 cm Ø	6	1	32.90	29.61	26.32



Teller tief Europa

		Stück	1	60	120	
				10 %	20 %	
137 06 07	(G), Teller tief, 24 cm Ø	6	1	21.00	18.90	16.80



Schüsseln / Schalen rund

		Stück	1	60	120	
				10 %	20 %	
137 06 08	6 cm Ø, 4 cl, H: 3.4 cm	6	1	11.50	10.35	9.20
137 06 27	7.8 cm Ø, H: 4.2 cm, 10 cl	6	1	12.70	11.43	10.16
137 06 10	9.5 cm Ø, H: 4.8 cm, 17 cl	6	1	13.70	12.33	10.96
137 06 11	11.5 cm Ø, H: 5.6 cm, 30 cl	6	1	14.40	12.96	11.52
137 06 09	12 cm Ø, H: 8 cm, 45 cl	6	1	15.60	14.04	12.48
137 06 13	14 cm Ø, H: 7 cm, 0.5 l	6	1	23.40	21.06	18.72
137 06 28	18.5 cm Ø, H: 7.5 cm, 1.1 l	6	1	41.20	37.08	32.96
137 06 15	22.5 cm Ø, H: 8.6 cm, 2.0 l	6	1	57.50	51.75	46.00



Tassen Europa

		Stück	1	60	120	
				10 %	20 %	
137 06 50	Espresso-Obertasse, 0.1 l	6	1	12.00	10.80	9.60
137 06 74	(G), Espresso-Untertasse, 12.5 cm Ø	6	1	9.30	8.37	7.44
137 06 52	Kaffee-Obertasse, 0.18 l	6	1	12.70	11.43	10.16
137 06 75	(G), Kombi-Untertasse, 14.5 cm Ø	6	1	9.80	8.82	7.84
137 06 72	Kaffee-Obertasse, 0.28 l	6	1	14.20	12.78	11.36
137 06 76	(G), Kombi-Untertasse, 16 cm Ø	6	1	11.20	10.08	8.96





Norge - Figgjo Porzellan

Funktionell, zeitlos und praktisch. Die Serie Norge besticht durch klare Linien. Die schmale Fahne sorgt für grosse Servierflächen. Die Teller lassen sich perfekt stapeln. Optisch ansprechend und sehr zweckmässig im Einsatz.

(G) - 5 Jahre Garantie auf Tellerkantenabsplitterung | (%) Mengenrabatte innerhalb der Marke Figgjo, auch gemischt

ab
5.44



Teller flach Norge

		Stück	1	60	120	
				10 %	20 %	
137 11 74	(G), Teller flach, 17 cm Ø	6	1	6.80	6.12	5.44
137 11 72	(G), Teller flach, 21 cm Ø	6	1	9.70	8.73	7.76
137 11 77	(G), Teller flach, 22.5 cm Ø	6	1	9.50	8.55	7.60
137 11 75	(G), Teller flach, 24 cm Ø	6	1	11.50	10.35	9.20
137 11 76	(G), Teller flach, 26.5 cm Ø	6	1	13.50	12.15	10.80



Teller tief Norge

		Stück	1	60	120	
				10 %	20 %	
137 11 78	(G), Teller tief, 21.5 cm Ø	6	1	11.00	9.90	8.80



Tassen und Untertassen Norge stapelbar

		Stück	1	60	120	
				10 %	20 %	
137 11 79	Kaffee-Obertasse stapelbar, 0.15 l	6	1	7.80	7.02	6.24
137 11 83	Kaffee-Obertasse stapelbar, 0.22 l	6	1	9.00	8.10	7.20
137 11 81	Mug stapelbar, 0.26 l	6	1	7.20	6.48	5.76
137 11 85	(G), Kombi-Untertasse, 14.5 cm Ø	6	1	9.50	8.55	7.60



Tassen und Untertassen Norge stapelbar

		Stück	1	60	120	
				10 %	20 %	
137 11 83	Kaffee-Obertasse stapelbar, 0.22 l	6	1	9.00	8.10	7.20
137 11 84	(G), Kombi-Untertasse, 14 cm Ø	6	1	7.80	7.02	6.24
137 11 85	(G), Kombi-Untertasse, 14.5 cm Ø	6	1	9.50	8.55	7.60

Table Top



Verde - Figgjo Porzellan

Die randlosen Coupe-Teller von Figgjo Verde bestechen durch ihre schlichte Form. Die Teller bieten eine grosse, offene Servierfläche. So kommen sowohl kleine Kreationen wie grössere Portionen perfekt zur Geltung.

(G) - 5 Jahre Garantie auf Tellerkantenabsplitterung | (%) Mengenrabatte innerhalb der Marke Figgjo, auch gemischt

Coupeteller Verde

		Stück	1	60	120	
				10 %	20 %	
137 10 36	(G), Teller flach, 17 cm Ø	6	1	12.20	10.98	9.76
137 10 37	(G), Teller flach, 21 cm Ø	6	1	16.30	14.67	13.04
137 10 30	(G), Teller flach, 26.5 cm Ø	6	1	22.10	19.89	17.68
137 10 31	(G), Teller flach, 30 cm Ø	6	1	25.00	22.50	20.00



Coupeteller tief Verde

		Stück	1	60	120	
				10 %	20 %	
137 10 33	(G), Teller tief, 21 cm Ø	6	1	19.00	17.10	15.20
137 10 44	(G), Teller tief, 27 cm Ø	6	1	27.60	24.84	22.08
137 10 45	(G), Teller tief, 29 cm Ø	6	1	29.10	26.19	23.28



Schale rechteckig Verde

		Stück	1	60	120	
				10 %	20 %	
137 09 25	Schale rechteckig, 15 x 7.5 cm	6	1	17.10	15.39	13.68



Porzellan mit eigenem Dekor oder Signet ab 48 Stk





Grad - Figgjo Porzellan

Elegant und funktional zugleich. Grad eignet sich als Bankett-Geschirr genauso gut wie auch für moderne Restaurants und klassische Brasserie-/Bistro-Konzepte. Grad, in Sachen Porzellan der moderne Klassiker.

(G) - 5 Jahre Garantie auf Tellerkantenabsplitterung | (%) Mengenrabatte innerhalb der Marke Figgjo, auch gemischt

ab
7,60



Teller flach Grad

			Stück	1	60	120
					10 %	20 %
137 06 41	(G), Teller flach, 14.5 cm Ø	6	1	9.50	8.55	7.60
137 06 31	(G), Teller flach, 17 cm Ø	6	1	10.50	9.45	8.40
137 06 32	(G), Teller flach, 21 cm Ø	6	1	13.50	12.15	10.80
137 06 33	(G), Teller flach, 24 cm Ø	6	1	17.90	16.11	14.32
137 06 34	(G), Teller flach, 27 cm Ø	6	1	20.10	18.09	16.08
137 06 35	(G), Teller flach, 30 cm Ø	6	1	23.00	20.70	18.40
137 06 36	(G), Teller flach, breite Fahne, 27 cm Ø	6	1	26.10	23.49	20.88
137 06 44	(G), Teller flach, 32 cm Ø	6	1	27.70	24.93	22.16



Teller tief Grad

			Stück	1	60	120
					10 %	20 %
137 06 43	(G), Teller tief, 21 cm Ø	6	1	15.00	13.50	12.00
137 06 37	(G), Teller tief, 24 cm Ø	6	1	18.80	16.92	15.04
137 06 38	(G), Teller tief, 30 cm Ø	6	1	24.70	22.23	19.76



Teller extra tief Grad

			Stück	1	60	120
					10 %	20 %
137 06 42	(G), Teller tief, breite Fahne, 27 cm Ø	6	1	22.10	19.89	17.68
137 06 39	(G), Teller tief, breite Fahne, 32 cm Ø	4	1	33.40	30.06	26.72
137 06 40	(G), Teller halbtief, 32 cm Ø	6	1	31.10	27.99	24.88



Tassen und Untertassen Grad

			Stück	1	60	120
					10 %	20 %
137 06 50	Espresso-Obertasse, 0.1 l	6	1	12.00	10.80	9.60
137 06 77	(G), Espresso-Untertasse, 12.5 cm Ø	6	1	9.50	8.55	7.60
137 06 52	Kaffee-Obertasse, 0.18 l	6	1	12.70	11.43	10.16
137 06 78	(G), Kombi-Untertasse, 14.5 cm Ø	6	1	10.00	9.00	8.00
137 06 72	Kaffee-Obertasse, 0.28 l	6	1	14.20	12.78	11.36
137 06 79	(G), Kombi-Untertasse, 16 cm Ø	6	1	11.70	10.53	9.36

Table Top

Front Dining - Figgjo Porzellan

In Figgjo Front Dining ist Klassik und Moderne vereint. Die Formen fügen sich in die Umgebung ein - sie sind speziell ohne aufdringlich zu sein - das servierte Gericht steht hier im Mittelpunkt. Erfüllt auch die Ansprüche der gehobenen Gastronomie.

Front flach Dining

		Stück	1	60	120	
				10 %	20 %	
137 10 01	Teller flach, 17 cm Ø	6	1	12.60	11.34	10.08
137 10 02	Teller flach, 27 cm Ø	6	1	25.40	22.86	20.32
137 10 03	Teller flach, 32 cm Ø	6	1	36.50	32.85	29.20
137 10 04	Teller flach, breite Fahne, 30 cm Ø	6	1	30.00	27.00	24.00



Front flach Dining

		Stück	1	60	120	
				10 %	20 %	
137 10 05	Teller flach coupe, 15 cm Ø	6	1	11.50	10.35	9.20
137 10 06	Teller flach coupe, 21 cm Ø	6	1	17.00	15.30	13.60
137 10 07	Teller flach coupe, 30 cm Ø	6	1	28.10	25.29	22.48



Front tief Dining

		Stück	1	60	120	
				10 %	20 %	
137 10 24	Teller tief, 20 cm Ø	6	1	21.30	19.17	17.04
137 10 25	Teller tief, 24 cm Ø	6	1	23.40	21.06	18.72
137 10 26	Teller tief, 27 cm Ø	6	1	29.00	26.10	23.20



Front tief Dining

		Stück	1	60	120	
				10 %	20 %	
137 10 08	Teller tief, 24 cm Ø	6	1	23.00	20.70	18.40
137 10 09	Teller tief, 27 cm Ø	6	1	27.60	24.84	22.08



Teller eckig Front Flat

		Stück	1	60	120	
				10 %	20 %	
137 07 99	34 x 34 cm	1	1	79.10	71.19	63.28
137 08 11	14 x 14 cm	6	1	15.90	14.31	12.72
137 08 12	25 x 25 mm	6	1	33.00	29.70	26.40



Clochen Front Dining

		Stück	1	60	120	
				10 %	20 %	
137 10 10	Cloche, 12.5 cm Ø, H: 12.5 cm	2	1	17.80	16.02	14.24
137 10 11	Cloche, 15.2 cm Ø, H: 14 cm	2	1	23.00	20.70	18.40



Tassen und Untertassen Front Dining

		Stück	1	60	120	
				10 %	20 %	
137 10 12	Espresso-Obertasse, 0.08 l	6	1	13.40	12.06	10.72
137 10 15	Espresso-Untertasse, 12.5 cm Ø	6	1	10.30	9.27	8.24
137 10 13	Kaffee-Obertasse, 0.18 l	6	1	14.90	13.41	11.92
137 10 16	Kaffee-Untertasse, 14.5 cm Ø	6	1	11.20	10.08	8.96
137 10 14	Kaffee-Obertasse, 0.3 l	6	1	16.80	15.12	13.44
137 10 17	Kaffee-Untertasse, 16 cm Ø	6	1	12.20	10.98	9.76



Krug mit Henkel Figgjo

		Stück	1	60	120	
				10 %	20 %	
137 06 57	Krug mit Henkel, 0.7 l	2	1	54.90	49.41	43.92
137 06 58	Krug mit Henkel, 1.2 l	6	1	65.90	59.31	52.72





Ting - Figgjo Porzellan

Das aussergewöhnliche Design von Ting zieht die Blicke auf sich. Die steile Fahne verleiht dieser Serie ihren speziellen Look und die Servierfläche wird dadurch besonders gross. Ting, die zeitgemässe Art Ihre Speisen zu präsentieren.

(G) - 5 Jahre Garantie auf Tellerkantenabsplitterung | (%) Mengenrabatte innerhalb der Marke Figgjo



Schale flach Ting

		Stück	1	60	120	
				10 %	20 %	
137 07 40	(G), Schale flach, 12,5 cm Ø, H: 3,5 cm	6	1	8.60	7.74	6.88
137 07 41	(G), Schale flach, 17 cm Ø, H: 3,5 cm	6	1	9.30	8.37	7.44
137 07 43	(G), Teller flach, 24 cm Ø, H: 3,5 cm	6	1	18.30	16.47	14.64
137 07 45	(G), Teller flach, 32 cm Ø, H: 3,5 cm	6	1	32.00	28.80	25.60



Schale tief Ting

		Stück	1	60	120	
				10 %	20 %	
137 07 46	(G), Schale tief, 14,5 cm Ø, H: 5 cm	6	1	13.50	12.15	10.80
137 07 47	(G), Schale tief, 17 cm Ø, H: 5 cm	6	1	16.60	14.94	13.28
137 07 48	(G), Schale tief, 21 cm Ø, H: 5 cm	6	1	17.50	15.75	14.00



Tassen und Untertassen Ting

		Stück	1	60	120	
				10 %	20 %	
137 07 49	Espresso-Obertasse, 0,08 l	6	1	11.00	9.90	8.80
137 07 52	Espresso-Obertasse o. Henkel, 0,08 l	6	1	10.70	9.63	8.56
137 07 50	Kaffee-Obertasse, 0,18 l	6	1	12.50	11.25	10.00
137 07 53	Kaffee-Obertasse o. Henkel, 0,18 l	6	1	11.70	10.53	9.36
137 07 55	(G), Kombi-Untertasse, 12,5 cm Ø	6	1	9.50	8.55	7.60
137 07 51	Kaffee-Obertasse, 0,28 l	6	1	15.80	14.22	12.64
137 07 54	Kaffee-Obertasse o. Henkel, 0,28 l	6	1	15.30	13.77	12.24
137 07 57	Bowl, 0,6 l, 13,7 cm Ø	6	1	21.50	19.35	17.20
137 07 56	(G), Kombi-Untertasse, 17 cm Ø	6	1	10.30	9.27	8.24

Porzellan mit eigenem Dekor oder Signet ab 48 Stk



Table Top



Pax - Figgjo Porzellan

Feine und sanfte Linien endend mit einer weichen Kante. Eleganz und Einfachheit, liegen ausgesprochen leicht in der Hand. Erhältlich in erdigen Farben olivgrün, grau und beige, die das natürliche Design unterstreichen.

(G) - 5 Jahre Garantie auf Tellerkantenabsplitterung | (%) Mengenrabatte innerhalb der Marke Figgjo

Teller flach Pax

	Stück	1	60	120
			10 %	20 %
134 052 00 (G), 22 cm Ø, H: 1.6 cm, weiss	6	1	14.40	12.96
134 052 01 (G), 22 cm Ø, H: 1.6 cm, beige	6	1	17.10	19.80
134 052 03 (G), 22 cm Ø, H: 1.6 cm, oliv	6	1	17.10	19.80
134 052 02 (G), 22 cm Ø, H: 1.6 cm, grau	6	1	17.10	19.80
134 052 04 (G), 26 cm Ø, H: 1.6 cm, weiss	6	1	17.10	16.20
134 052 05 (G), 26 cm Ø, H: 1.6 cm, beige	6	1	17.10	23.40
134 052 07 (G), 26 cm Ø, H: 1.6 cm, oliv	6	1	17.10	23.40
134 052 06 (G), 26 cm Ø, H: 1.6 cm, grau	6	1	17.10	23.40



Teller/Platte rechteckig Pax

	Stück	1	60	120
			10 %	20 %
134 052 08 (G), 22 x 13 cm Ø, H: 1.6 cm, weiss	6	1	23.00	16.92
134 052 09 (G), 22 x 13 cm Ø, H: 1.6 cm, beige	6	1	34.00	23.58
134 052 11 (G), 22 x 13 cm Ø, H: 1.6 cm, oliv	6	1	34.00	23.58
134 052 10 (G), 22 x 13 cm Ø, H: 1.6 cm, grau	6	1	34.00	23.58
134 052 12 (G), 41 x 13 cm Ø, H: 1.6 cm, weiss	6	1	35.00	23.58
134 052 13 (G), 41 x 13 cm Ø, H: 1.6 cm, beige	6	1	49.00	44.10
134 052 15 (G), 41 x 13 cm Ø, H: 1.6 cm, oliv	6	1	49.00	44.10
134 052 14 (G), 41 x 13 cm Ø, H: 1.6 cm, grau	6	1	49.00	44.10



Bowl Pax

	Stück	1	60	120
			10 %	20 %
134 052 16 (G), 14 cm Ø, H: 6.5 cm, 50 cl, weiss	6	1	31.20	28.08
134 052 17 (G), 14 cm Ø, H: 6.5 cm, 50 cl, beige	6	1	31.20	28.08
134 052 19 (G), 14 cm Ø, H: 6.5 cm, 50 cl, oliv	6	1	31.20	28.08
134 052 18 (G), 14 cm Ø, H: 6.5 cm, 50 cl, grau	6	1	31.20	28.08



Base



Base - Figgjo Porzellan

"Bistronomie" umschreibt den neuen Trend zu qualitätsvollen Speisen, aufgetischt in lockerer und ungezwungener Atmosphäre. Eine Mischung aus Bistro, Brasserie und gehobener Gastronomie. Base ist für diese neue "Bistronomie" wie geschaffen.

(G) - 5 Jahre Garantie auf Tellerkantenabsplitterung | (%) Mengenrabatte innerhalb der Marke Figgjo



ab
8.48

Teller flach Base

		Stück	1	60	120	
				10 %	20 %	
137 13 59	(G), Teller flach, 14.5 cm Ø	6	1	10.60	9.54	8.48
137 13 58	(G), Teller flach, 23 cm Ø	6	1	16.90	15.21	13.52
137 13 57	(G), Teller flach, 27 cm Ø	6	1	23.20	20.88	18.56
137 13 43	(G), Teller flach, 20 cm Ø	6	1	13.20	11.88	10.56
137 13 42	(G), Teller flach, 30 cm Ø	6	1	26.60	23.94	21.28

Table Top

Teller mit Rand Base

		Stück	1	60	120	
				10 %	20 %	
137 13 54	Teller mit Rand, 17 cm Ø, H: 4 cm	6	1	14.00	12.60	11.20
137 13 55	Teller mit Rand, 22 cm Ø, H: 4 cm	6	1	19.60	17.64	15.68
137 13 41	Teller mit Rand, 27 cm Ø, H: 4 cm	6	1	23.40	21.06	18.72



Teller tief Base

		Stück	1	60	120	
				10 %	20 %	
137 13 61	Teller tief, 20 cm Ø	6	1	23.30	20.97	18.64
137 13 66	Teller tief, 24 cm Ø	6	1	27.00	24.30	21.60



Teller halbtief Base

		Stück	1	60	120	
				10 %	20 %	
137 13 44	Teller halbtief, 27 cm Ø	6	1	24.70	22.23	19.76



Teller mit Griff Base

		Stück	1	60	120	
				10 %	20 %	
137 13 40	Teller flach mit Griff, 27 x 33.5 cm	6	1	42.10	37.89	33.68



Schale mit Griff Base

		Stück	1	60	120	
				10 %	20 %	
137 13 62	Bowl mit Griff, 16 x 18.5 cm, H: 6.3 cm	6	1	34.90	31.41	27.92



Teller mit Griff Base

		Stück	1	60	120	
				10 %	20 %	
137 13 46	Teller flach mit Griff, 10 x 24 cm	6	1	27.70	24.93	22.16
137 13 45	Teller flach mit Griff, 18 x 28 cm	6	1	37.80	34.02	30.24
137 13 56	Schale, 10 cm Ø, 14	6	1	13.50	12.15	10.80



Tasse und Untertasse Base

		Stück	1	60	120	
				10 %	20 %	
137 13 63	Espresso-Obertasse, 0.08 l	6	1	12.70	11.43	10.16
137 13 64	Espresso-Obertasse o. Henkel, 0.08 l	6	1	11.70	10.53	9.36
137 13 65	(G), Espresso-Untertasse, 12.7 cm Ø	6	1	9.30	8.37	7.44
137 13 48	Kaffee-Obertasse, 0.19 l	6	1	13.20	11.88	10.56
137 13 50	Mug, 0.22 l	6	1	14.00	12.60	11.20
137 13 51	Mug, 0.26 l	6	1	14.90	13.41	11.92
137 13 47	Obertasse, 50 cl, 12 cm Ø	6	1	18.70	16.83	14.96
137 13 53	(G), Kaffee-Untertasse, 14.5 cm Ø	6	1	9.40	8.46	7.52
137 06 80	(G), Untertasse, 17 cm Ø	6	1	13.40	12.06	10.72



Giesser ohne Henkel Figjo

		Stück	1	60	120	
				10 %	20 %	
137 12 10	Giesser ohne Henkel, 0.08 l	6	1	16.20	14.58	12.96
137 12 11	Giesser ohne Henkel, 0.15 l	6	1	18.90	17.01	15.12
137 12 12	Giesser ohne Henkel, 0.3 l	2	1	22.80	20.52	18.24





Dryss

7x11 Standard Brown

- 1x10
- 4x10
- 2x01
- 2x16
- 5x08
- 5x26
- 5x09
- 3x42
- 3x35
- 3x25
- 8x09
- 8x10

Individuell und einzigartig - in verschiedenen Farben erhältlich.
Bereits ab 48 Stück - wir beraten Sie gerne!

Strok



Flom



Skygge

Table Top



7x11 Standard

1x10 4x10 2x01 2x16 5x08 5x26 5x09 3x42 3x35 3x25 8x09 8x10 ab 48 Stück

Strok - Figgjo Porzellan

Figgjo Strok wird in Handarbeit gefertigt. Der markante Streifen, ein Klassiker, der auf den neuen Teilen aktueller und moderner denn je ist und Ihre Kreationen in den Mittelpunkt rückt. (G) - 5 Jahre Garantie auf Tellerkantenabsplitterung

Teller flach Strok

		Stück	1	60	120	
				10 %	20 %	
137 13 72	(G), Teller flach, 14,5 cm Ø	6	1	14.40	12.96	11.52
137 13 71	(G), Teller flach, 20 cm Ø	6	1	17.10	15.39	13.68
137 13 84	(G), Teller flach, 23 cm Ø	6	1	22.60	20.34	18.08
137 13 83	(G), Teller flach, 27 cm Ø	6	1	31.00	27.90	24.80
137 13 70	(G), Teller flach, 30 cm Ø	6	1	35.40	31.86	28.32



Teller mit Rand Strok

		Stück	1	60	120	
				10 %	20 %	
137 13 75	Teller mit Rand, 17 cm Ø, H: 4 cm	6	1	18.80	16.92	15.04
137 13 85	Teller mit Rand, 22 cm Ø, H: 4 cm	6	1	26.20	23.58	20.96
137 13 74	Teller mit Rand, 27 cm Ø, H: 4 cm	6	1	31.30	28.17	25.04



Teller tief Strok

		Stück	1	60	120	
				10 %	20 %	
137 13 82	Teller tief, 20 cm Ø	6	1	31.20	28.08	24.96



Teller halbtief Strok

		Stück	1	60	120	
				10 %	20 %	
137 13 73	Teller halbtief, 27 cm Ø	6	1	32.00	28.80	25.60



Schale Strok

		Stück	1	60	120	
				10 %	20 %	
137 13 86	(G), Schale, H: 3.5 cm, 10 cm Ø, 14 cl	6	1	18.10	16.29	14.48



Tassen und Untertassen Strok

		Stück	1	60	120	
				10 %	20 %	
137 13 76	Kaffee-Obertasse, 0.19 l	6	1	18.00	16.20	14.40
137 13 78	Mug, 0.22 l	6	1	18.80	16.92	15.04
137 13 79	Mug, 0.26 l	6	1	19.70	17.73	15.76
137 13 80	Obertasse, 50 cl, 12 cm Ø	6	1	23.70	21.33	18.96
137 13 77	(G), Kaffee-Untertasse, 14.5 cm Ø	6	1	13.60	12.24	10.88
137 13 81	(G), Untertasse, 17 cm Ø	6	1	18.40	16.56	14.72





7x11 Standard

4x10 5x08 5x26 5x09 3x42 3x35 3x25 8x09 8x10 ab 48 Stück

Flom - Figgjo Porzellan

Figgjo Flom hat ein natürliches, fließendes Aussehen und wird von Hand dekoriert. Daher ist jeder Teller ein Unikat. Mit Flom setzt Figgjo einmal mehr Trends!

(G) - 5 Jahre Garantie auf Tellerkantenabsplitterung | (%) Mengenrabatte innerhalb der Marke Figgjo, auch gemischt



Teller flach Flom

			Stück	1	60	120
					10 %	20 %
137 13 22	(G), Teller flach, 14.5 cm Ø	6	1	20.60	18.54	16.48
137 13 21	(G), Teller flach, 20 cm Ø	6	1	25.00	22.50	20.00
137 13 28	(G), Teller flach, 23 cm Ø	6	1	27.80	25.02	22.24
137 13 27	(G), Teller flach, 27 cm Ø	6	1	38.20	34.38	30.56
137 13 20	(G), Teller flach, 30 cm Ø	6	1	43.50	39.15	34.80



Teller mit Rand Flom

			Stück	1	60	120
					10 %	20 %
137 13 30	Teller mit Rand, 17 cm Ø, H: 4 cm	6	1	25.00	22.50	20.00
137 13 29	Teller mit Rand, 22 cm Ø, H: 4 cm	6	1	32.30	29.07	25.84
137 13 23	Teller mit Rand, 27 cm Ø, H: 4 cm	6	1	38.60	34.74	30.88



Teller halbtief Flom

			Stück	1	60	120
					10 %	20 %
137 13 24	Teller halbtief, 27 cm Ø	6	1	39.40	35.46	31.52



Teller tief Flom

			Stück	1	60	120
					10 %	20 %
137 13 26	Teller tief, 20 cm Ø	6	1	38.40	34.56	30.72



Schale Flom

			Stück	1	60	120
					10 %	20 %
137 13 31	(G), Schale, H: 3.5 cm, 10 cm Ø, 14 cl	6	1	22.30	20.07	17.84

Table Top



7x11

Standard

1x10

4x10

2x01

2x16

5x08

5x26

5x09

3x42

3x35

3x25

8x09

8x10

ab 48 Stück

Skygge - Figgjo Porzellan

Figgjo Skygge bringt Farbe auf den Tisch. In Sprühtechnik von Hand gearbeitet ist jedes Teil ein Unikat. Spannende Kreationen aus Farbe und Food. In braun als Standardfarbe erhältlich, viele weitere Farben möglich.

(G) - 5 Jahre Garantie auf Tellerkantenabsplitterung | (%) Mengenrabatte innerhalb der Marke Figgjo, auch gemischt

Teller flach Skygge

	Stück	1	60	120
			10 %	20 %
137 02 585 (G), Teller flach, 14,5 cm Ø	6	1	17.10	15.39 13.68
137 02 285 (G), Teller flach, 23 cm Ø	6	1	24.90	22.41 19.92
137 02 385 (G), Teller flach, 27 cm Ø	6	1	33.40	30.06 26.72
137 13 60 (G), Teller flach, 30 cm Ø	6	1	38.10	34.29 30.48



Teller mit Rand Skygge

	Stück	1	60	120
			10 %	20 %
137 02 485 Teller mit Rand, 22 cm Ø, H: 4 cm	6	1	28.20	25.38 22.56
137 02 185 Teller mit Rand, 27 cm Ø, H: 4 cm	6	1	33.70	30.33 26.96



Teller mit Griff Skygge

	Stück	1	60	120
			10 %	20 %
137 02 985 Teller flach mit Griff, 10 x 24 cm	6	1	39.00	35.10 31.20
137 02 885 Teller flach mit Griff, 18 x 28 cm	6	1	54.60	49.14 43.68



Teller flach Flom schwarz, 8x10

	Stück	1	60	120
			10 %	20 %
137 002 99 (G), Teller flach, 23 cm Ø	6	1	27.80	25.02 22.24
137 003 99 (G), Teller flach, 27 cm Ø	6	1	38.20	34.38 30.56
137 006 99 (G), Teller flach, 30 cm Ø	6	1	43.50	39.15 34.80



Teller mit Rand Flom schwarz, 8x10

	Stück	1	60	120
			10 %	20 %
137 004 99 Teller mit Rand, 22 cm Ø, H: 4 cm	6	1	32.30	29.07 25.84
137 001 99 Teller mit Rand, 27 cm Ø, H: 4 cm	6	1	38.20	34.38 30.56



Changing tables - Figgjo Porzellan (%) Mengenrabatte innerhalb der Marke Figgjo



Schalen Front Hval

		Stück	1	60	120	
				10 %	20 %	
137 07 90	10.5 x 4 cm	6	1	15.10	13.59	12.08
137 07 91	13.5 x 5.6 cm	6	1	16.90	15.21	13.52
137 07 92	15.5 x 5.6 cm	6	1	18.30	16.47	14.64
		Stück				1
137 08 00*	58 x 24 cm	1	1	80.00		80.00



Schalen Bonsai Front

		Stück	1	60	120	
				10 %	20 %	
137 07 79	6 x 6 cm, 0.08 l, H: 5 cm	6	1	17.80	16.02	14.24
137 07 80	12 x 8 cm, 0.1 l, H: 3 cm	6	1	20.30	18.27	16.24
137 07 81	12 x 12 cm, 0.5 l, H: 8 cm	6	1	26.60	23.94	21.28



Giesser ohne Henkel Figgjo

		Stück	1	60	120	
				10 %	20 %	
137 12 10	Giesser ohne Henkel, 0.08 l	6	1	16.20	14.58	12.96
137 12 11	Giesser ohne Henkel, 0.15 l	6	1	18.90	17.01	15.12
137 12 12	Giesser ohne Henkel, 0.3 l	2	1	22.80	20.52	18.24



Schalen stapelbar Pisa

		Stück	1	60	120	
				10 %	20 %	
137 12 43	Schale, 9 x 9.5 cm, H: 5.3 cm, 25 cl	6	1	17.30	15.57	13.84
137 12 44	Deckel/Teller zu 1371243, 9 cm Ø	6	1	8.70	7.83	6.96
137 12 45	Schale, 11.5 x 12 cm, H: 5.7 cm, 43 cl	3	1	21.20	19.08	16.96
137 12 46	Deckel/Teller zu 1371245, 11.5 cm Ø	3	1	10.80	9.72	8.64



Präsentierteller eckig Front

		Stück	1	60	120	
				10 %	20 %	
137 08 06	quadratisch, 9 x 9 cm	6	1	29.80	26.82	23.84
137 08 07	rechteckig, 21 x 9 cm	3	1	43.00	38.70	34.40
137 08 08	rechteckig, 42 x 12 cm	6	1	91.30	82.17	73.04
137 08 09	rechteckig, 21 x 18 cm	3	1	48.30	43.47	38.64
137 08 10	rechteckig, 30 x 21 cm	6	1	59.30	53.37	47.44



Teller rechteckig und rund A4 Front

		Stück	1	60	120	
				10 %	20 %	
137 08 13	Teller A4, 21 x 30 cm	3	1	52.80	47.52	42.24
137 07 93	Podium A4, 17 cm Ø	6	1	45.70	41.13	36.56



Teller flach und tief Felt

		Stück	1	60	120	
				10 %	20 %	
137 12 30	(G), Teller flach, 30 cm Ø	6	1	27.20	24.48	21.76
137 12 31	(G), Teller flach, 32 cm Ø	6	1	35.70	32.13	28.56
137 12 34	(G), Teller tief, 27 cm Ø	6	1	26.70	24.03	21.36
137 12 35	(G), Teller halbtief, 30 cm Ø	6	1	28.90	26.01	23.12

Table Top



Neuheiten - Figgjo Porzellan (%) Mengenrabatte innerhalb der Marke Figgjo

Teller flach mit Loch Undring

		Stück	1	60	120
137 11 17	Teller flach, 30 cm Ø	6	1	48.10	38.48
				10 %	20 %



Schalen Undring

		Stück	1	60	120
137 11 18	6 cm Ø, H: 3.5 cm, 4 cl	6	1	12.40	9.92
137 11 19	6 cm Ø, H: 6.5 cm, 10 cl	6	1	15.40	12.32
137 11 20	6 cm Ø, H: 9.3 cm, 15 cl	6	1	18.00	14.40



Schale Duett

		Stück	1	60	120
137 11 21	Schale, 9.3 cm Ø, H: 5.2 cm, 17 cl	6	1	16.40	13.12
137 11 22	Deckel/Teller zu 1371121, 9.3 cm Ø, H: 4.1 cm	6	1	28.30	22.64



Teller flach Kvadrat Front

		Stück	1	60	120
137 12 24	Teller flach, 14 x 14 cm	6	1	19.70	15.76
137 12 25	Teller flach, 24 x 24 cm	6	1	29.90	23.92
137 12 26	Teller flach, 27 x 27 cm	6	1	35.50	28.40
137 12 16	Teller flach, 20 x 20 cm	6	1	22.90	18.32



ab
15.76



SERAX www.serax-schweiz.ch

Base – Dusk – Pure, die ideale Basis des kreativen Schaffens

Drei Linien von Serax ein Zusammenspiel von Design und Funktionalität. Piet Boon legt mit Base den Blick fürs Detail und den Fokus auf Perfektion. Martine Keirsebilck entwarf Dusk aus weichem schamottenlosem Material in anthrazitgrauer Farbe. Pascale Naessens verlieh Pure eine romantische Note mit unkonventionellen Farben.

ab
3,28



Teller flach Piet Boon - Base

		Stück	1	40
130 000 08	Teller flach, 8 cm Ø, H: 1.5 cm	8	4.10	3.28
130 000 12	Teller flach, 12 cm Ø, H: 1.5 cm	8	6.70	5.36
130 000 16	Teller flach, 16 cm Ø, H: 1.5 cm	4	11.10	8.88
130 000 20	Teller flach, 20 cm Ø, H: 1.5 cm	4	15.20	12.16
130 000 24	Teller flach, 24 cm Ø, H: 1.5 cm	4	19.20	15.36
130 000 28	Teller flach, 28 cm Ø, H: 1.5 cm	4	28.00	22.40
130 000 32	Teller flach, 32 cm Ø, H: 1.5 cm	2	37.10	29.68

Teller hoch Piet Boon - Base



		Stück	1	40
130 001 12	Teller hoch, 12 cm Ø, H: 3 cm	4	9.20	7.36
130 001 16	Teller hoch, 16 cm Ø, H: 3 cm	4	13.10	10.48
130 001 20	Teller hoch, 20 cm Ø, H: 3 cm	4	20.30	16.24
130 001 24	Teller hoch, 24 cm Ø, H: 3 cm	4	25.50	20.40
130 001 28	Teller hoch, 28 cm Ø, H: 3 cm	2	35.60	28.48
130 001 32	Teller hoch, 32 cm Ø, H: 3 cm	2	44.60	35.68

Teller tief Piet Boon - Base



		Stück	1	40
130 004 16	Teller tief, 16 cm Ø, H: 4.5 cm	4	17.50	14.00
130 004 20	Teller tief, 20 cm Ø, H: 4.5 cm	4	26.90	21.52
130 004 24	Teller tief, 24 cm Ø, H: 4.5 cm	4	33.10	26.48
130 004 28	Teller tief, 28 cm Ø, H: 4.5 cm	4	45.90	36.72

Bowl hoch Piet Boon - Base



		Stück	1	40
130 007 12	Bowl hoch, 12 cm Ø, H: 7.5 cm	4	15.90	12.72
130 007 16	Bowl hoch, 16 cm Ø, H: 7.5 cm	4	25.80	20.64
130 007 20	Bowl hoch, 20 cm Ø, H: 7.5 cm	4	40.20	32.16

Dusk

individuell inspiriert, aus Keramik



		Stück	1	40
130 054 11	Teller flach, 11 cm Ø, H: 2.5 cm	4	8.40	6.72
130 059 09	Bowl, 9 cm Ø, H: 6.3 cm	4	8.40	6.72
130 059 12	Bowl, 11.5 cm Ø, H: 5.6 cm	4	10.10	8.08
130 058 09	double-use, 9 cm Ø, H: 4 cm	4	9.90	7.92
130 058 09	double-use, 17.5 cm Ø, H: 4 cm	4	22.80	18.24

Bowl Pure

Kontrast mit Flair, aus Keramik



		Stück	1	40
130 030 50	Bowl, 13.5 cm Ø, H: 6.5 cm	6	8.40	6.72
130 031 55	Bowl, 20 cm Ø, H: 5 cm	4	14.00	11.20
130 037 98	Bowl, 20 cm Ø, H: 9 cm, schwarz	4	25.60	20.48

Merci - Serax aus Sandstein

Einmalige und funktionale kleine Schalen und Teller die sich am berühmten "American Modern Dinnerware" von Russel Wright und am traditionellen japanischen "Bento" inspirieren. Individuelle Gelüste, verführerische Tapas, kleine und feine Geschmackskompositionen - von allem etwas - Merci.

Platten Merci

		Stück	1	40	
				20 %	
134 053 00	14.5 cm x 10.5 cm, H: 1.4 cm, weiss	8	1	9.40	7.52
134 053 65	14.5 cm x 10.5 cm, H: 1.4 cm, blau/grau	8	1	9.40	7.52
134 053 68	14.5 cm x 10.5 cm, H: 1.4 cm, dunkelblau	8	1	9.40	7.52
134 053 85	14.5 cm x 10.5 cm, H: 1.4 cm, ockerbraun	8	1	9.40	7.52
134 054 00	23 cm x 15 cm, H: 1.4 cm, weiss	8	1	16.30	13.04
134 054 65	23 cm x 15 cm, H: 1.4 cm, blau/grau	8	1	16.30	13.04
134 054 68	23 cm x 15 cm, H: 1.4 cm, dunkelblau	8	1	16.30	13.04
134 054 85	23 cm x 15 cm, H: 1.4 cm, ockerbraun	8	1	16.30	13.04
134 053 00	32 cm x 23 cm, H: 1.4 cm, weiss	4	1	32.70	26.16
134 053 65	32 cm x 23 cm, H: 1.4 cm, blau/grau	4	1	32.70	26.16
134 053 68	32 cm x 23 cm, H: 1.4 cm, dunkelblau	4	1	32.70	26.16
134 053 85	32 cm x 23 cm, H: 1.4 cm, ockerbraun	4	1	32.70	26.16



Schalen Merci

		Stück	1	40	
				20 %	
134 059 00	10 cm x 6.5 cm, H: 2.5 cm, weiss	8	1	6.40	5.12
134 059 65	10 cm x 6.5 cm, H: 2.5 cm, blau/grau	8	1	6.40	5.12
134 059 68	10 cm x 6.5 cm, H: 2.5 cm, dunkelblau	8	1	6.40	5.12
134 059 85	10 cm x 6.5 cm, H: 2.5 cm, ockerbraun	8	1	6.40	5.12
134 058 00	14.5 cm x 10.5 cm, H: 3 cm, weiss	8	1	12.90	10.32
134 058 65	14.5 cm x 10.5 cm, H: 3 cm, blau/grau	8	1	12.90	10.32
134 058 68	14.5 cm x 10.5 cm, H: 3 cm, dunkelblau	8	1	12.90	10.32
134 058 85	14.5 cm x 10.5 cm, H: 3 cm, ockerbraun	8	1	12.90	10.32
134 057 00	14.5 cm x 10.5 cm, H: 4.5 cm, weiss	8	1	14.70	11.76
134 057 65	14.5 cm x 10.5 cm, H: 4.5 cm, blau/grau	8	1	14.70	11.76
134 057 68	14.5 cm x 10.5 cm, H: 4.5 cm, dunkelblau	8	1	14.70	11.76
134 057 85	14.5 cm x 10.5 cm, H: 4.5 cm, ockerbraun	8	1	14.70	11.76
134 056 00	23 cm x 15 cm, H: 5 cm, weiss	4	1	32.80	26.24
134 056 65	23 cm x 15 cm, H: 5 cm, blau/grau	4	1	32.80	26.24
134 056 68	23 cm x 15 cm, H: 5 cm, dunkelblau	4	1	32.80	26.24
134 056 85	23 cm x 15 cm, H: 5 cm, ockerbraun	4	1	32.80	26.24



Becher Merci

		Stück	1	40	
				20 %	
134 060 00	7.4 cm Ø, H: 7.3 cm, 0.15 l, weiss	8	1	7.70	6.16
134 060 65	7.4 cm Ø, H: 7.3 cm, 0.15 l, blau/grau	8	1	7.70	6.16
134 060 68	7.4 cm Ø, H: 7.3 cm, 0.15 l, dunkelblau	8	1	7.70	6.16
134 060 85	7.4 cm Ø, H: 7.3 cm, 0.15 l, ockerbraun	8	1	7.70	6.16





Surface - Sergio Herman Serax

Inspiziert wurde die Kollektion Surface von der zerklüfteten Natur von Seeland. Ihre Maserung und ihre wunderschöne Unvollkommenheit enthüllen was real und wahr ist. Das Erscheinungsbild von jedem einzelnen Stück aus der Serie Surface ist ein Symbol der Nordsee und deren unendlichen Tiefen als Verkörperung.

Teller flach Sergio Herman



		Stück	1	40
134 061 96	Teller flach, 16 cm Ø, indigrey	8 1	14.00	11.20
134 062 96	Teller flach, 24 cm Ø, indigrey	8 1	21.20	16.96
134 063 96	Teller flach, 27 cm Ø, indigrey	8 1	24.30	19.44
134 063 53	Teller flach, 27 cm Ø, camogreen	8 1	24.30	19.44

Teller tief Sergio Herman



		Stück	1	40
134 064 96	Teller tief, 16 cm Ø, H: 4 cm, indigrey	8 1	16.60	13.28
134 065 96	Teller tief, 19 cm Ø, H: 4 cm, indigrey	8 1	18.40	14.72

Schalen Sergio Herman



		Stück	1	40
134 069 96	Schale, 9 cm Ø, H: 2 cm, indigrey	8 1	6.10	4.88
134 069 53	Schale, 9 cm Ø, H: 2 cm, camogreen	8 1	6.10	4.88

Bowl Sergio Herman



		Stück	1	40
134 066 96	Bowl, 11 cm Ø, H: 4.5 cm, indigrey	8 1	11.00	8.80
134 067 96	Bowl, 15 cm Ø, H: 6.5 cm, indigrey	8 1	18.40	14.72

Giesser Sergio Herman



		Stück	1	40
134 068 96	7.5 cm Ø, 19 cl, Indigrey	8 1	11.60	9.28

Table Top

Teller Seasons hellblau

		Stück	1	60	120
				10 %	20 %
139 71 60	Teller flach, 18 cm Ø	6	1	9.20	8.28
139 72 60	Teller flach, 28 cm Ø	6	1	19.20	17.28
139 75 60	Teller tief, 26 cm Ø	6	1	22.10	19.89



Platte und Schalen Seasons hellblau

		Stück	1	60	120
				10 %	20 %
139 78 60	Teller flach, 35 x 26 cm	6	1	47.00	42.30
139 77 60	Schale, 50 ml	6	1	5.30	4.77
139 76 60	Schale, 200 ml	6	1	9.20	8.28



Teller Polar weiss

		Stück	1	60	120
				10 %	20 %
138 90 21	Teller flach, 21 cm Ø	6	1	11.80	10.62
138 90 28	Teller flach, 27.5 cm Ø	6	1	17.80	16.02
138 90 26	Teller tief, 25.5 cm Ø	6	1	23.20	20.88



Teller Honey schwarz

		Stück	1	60	120
				10 %	20 %
138 87 21	Teller flach, 21 cm Ø	6	1	11.80	10.62
138 87 28	Teller flach, 27.5 cm Ø	6	1	17.80	16.02
138 87 26	Teller tief, 25.5 cm Ø	6	1	23.20	20.88



Teller Croco braun

		Stück	1	60	120
				10 %	20 %
138 88 21	Teller flach, 21 cm Ø	6	1	11.80	10.62
138 88 28	Teller flach, 27.5 cm Ø	6	1	17.80	16.02
138 88 26	Teller tief, 25.5 cm Ø	6	1	23.20	20.88



Teller Leopard braun

		Stück	1	60	120
				10 %	20 %
138 89 21	Teller flach, 21 cm Ø	6	1	11.80	10.62
138 89 28	Teller flach, 27.5 cm Ø	6	1	17.80	16.02
138 89 26	Teller tief, 25.5 cm Ø	6	1	23.20	20.88



Miniconcept



Miniconcept

Präsentieren Sie mit MINICONCEPT Speisen andersartig und witzig. Ob Fischknusperli, Fritto Misto oder Tempura-Gerichte, was frittiert oder gebacken auf den Tisch kommt, macht in den Minidrahtkörbchen eine gute Figur. Man könnte auch sagen, „Fingerfood neu erfunden“, Pommes-Frites aus dem Minieimer, dazu das hauseigene Ketchup aus der Miniflasche oder Dip-Gemüse aus dem Minieimer, der Fantasie sind keine Grenzen gesetzt.



Miniconcept Fish and Chips

CNS 18/10

		Stück	1	12	30
240 70 00	Körbchen rund, 8 cm Ø, H: 8 cm	6	1	15.00	13.50 12.00
240 70 01	Körbchen rund, 9 cm Ø, H: 9.5 cm	6	1	17.00	15.30 13.60
240 70 50	Bügel-Halterung	1	1	2.50	2.25 2.00
		Stück	1	48	96
132 27 07	Bowl Conical, 7 cm Ø, H: 4.4 cm	24	1	4.50	4.05 3.60



Miniconcept Fish and Chips

CNS 18/10

		Stück	1	12	30
240 70 02	Körbchen quadratisch, 9.5 x 9.5 cm, H: 6.5 cm	1	1	17.00	15.30 13.60
240 70 03	Körbchen rechteckig, 21.5 x 10.5 cm, H: 6 cm	6	1	22.00	19.80 17.60
240 70 50	Bügel-Halterung	1	1	2.50	2.25 2.00
		Stück	1	48	96
132 27 07	Bowl Conical, 7 cm Ø, H: 4.4 cm	24	1	4.50	4.05 3.60

Table Top

Miniconcept Fish and Chips

Edelstahl goldfarben

		Stück	1	12	30
240 70 21	Körbchen rechteckig, 21.5 x 10.5 cm, H: 4.5 cm	6	1	26.00	23.40 20.80
					10 % 20 %



Miniconcept Snack Holder

Edelstahl, stapelbar, spülmaschinengeeignet

		Stück	1	12	30
240 77 85	Snack Holder, 8.5 cm Ø, H: 8.5 cm, 0.3 l	1	1	6.60	5.94 5.28
240 77 86	Snack Holder gehämmert, 8.5 cm Ø, H: 8.5 cm, 0.3 l	1	1	7.30	6.57 5.84



Miniconcept Servierpfanne

Edelstahl, stapelbar, spülmaschinengeeignet

		Stück	1	12	30
240 79 15	Servierpfanne, 14.5 x 9.5 cm, H: 4.5/6.5 cm, 0.5 l	1	1	18.00	16.20 14.40
					10 % 20 %



Miniconcept Paper / Ketch-up Flasche

Fettabweisendes, bedrucktes Papier

		Stück	1	12	30
240 70 13	Paper Daily Catch, 25.5 x 40.5 cm	1	500	82.00	73.80 65.60
					10 % 20 %
171 51 05	Ketch-up Flasche, 50 ml, H: 11.5 cm	20	1	2.40	2.16 1.92
					10 % 20 %
171 51 10	Ketch-up Flasche, 100 ml, H: 14.5 cm	16	1	2.50	2.25 2.00
					10 % 20 %



Miniconcept Eimer

CNS 18/10

		Stück	1	12	30
240 70 04	Eimer, 9.2 cm Ø, H: 8.5 cm	6	1	11.30	10.17 9.04
240 71 00	Eimer, 6 cm Ø, H: 5 cm	1	1	7.80	7.02 6.24
240 71 01	Serviergestell mit 2 Eimer, H: 10.5 cm, 9 cm	1	1	22.00	19.80 17.60



Miniconcept Pfännchen

CNS 18/10

		Stück	1	12	30
240 70 08	Bratpfännchen, 12 cm Ø, H: 3 cm	6	1	35.60	32.04 28.48
240 70 05	Pfännchen, 7 cm Ø, H: 4.5 cm	6	1	17.30	15.57 13.84
240 70 06	Pfännchen, 9 cm Ø, H: 6 cm	6	1	29.10	26.19 23.28
240 70 07	Deckel zu 2407006, 9.5 cm Ø	6	1	4.30	3.87 3.44



Miniconcept Akazienholzblech

		Stück	1	12	30
240 70 10	Akazienholzblech, 25.5 x 36 cm	1	1	34.60	31.14 27.68
240 70 09	Akazienholzblech, 18 x 36 cm	1	1	31.30	28.17 25.04



NEW



Miniconcept Emaille Wok

		Stück	1	12	30
240 81 14	14 cm Ø, H: 3.8 cm, 3.6 dl	10	1	16.10	12.88
240 81 16	16 cm Ø, H: 4 cm, 5.2 dl	10	1	17.20	13.76
240 81 18	18 cm Ø, H: 4.6 cm, 7.8 dl	6	1	19.30	15.44



Miniconcept Emaille Paelle Pfanne

		Stück	1	12	30
240 82 12	12 cm Ø	10	1	13.40	10.72
240 82 15	15 cm Ø	10	1	14.60	11.68
240 82 20	20 cm Ø	10	1	17.80	14.24



Aluminium-Tablett Snack

Aluminium, nicht spülmaschinengeeignet

		Stück	1	12	30
282 26 32	31.5 x 21.5 cm	1	1	17.30	15.57

16.24



Miniconcept Snack und Brot Wood

		Stück	1	12	30
211 19 25	25 x 12 cm, H: 7 cm	1	1	20.30	16.24



Miniconcept Paper

Fettabweisendes, bedrucktes Papier

		Stück	1	12	30
240 70 13	Paper Daily Catch, 25 x 42 cm	1	500	82.00	73.80
240 70 45	Karo rot, 25 x 42 cm	1	500	82.00	73.80
240 70 65	Karo blau, 25 x 42 cm	1	500	82.00	73.80
240 70 14	Steak House Burger, 25 x 35 cm	1	1000	88.60	79.74

NEW



Besteck-Caddy Vintage

Besteck-Behälter aus Holz im Vintage-Look

		Stück	1	12	30
204 12 00	11.5 cm Ø, H: 14 cm	1	1	31.00	24.80

Table Top



Emaille Blue

Emaille-Geschirr im Retro-Stil - der neue Trend.

Unzerbrechlich, kratzresistent, spülmaschinengeeignet und hitzebeständig bis 270° Grad.

Emaille Teller Blue

		Stück	1	60	120	
				10 %	20 %	
132 87 18	18 cm Ø	12	1	10.30	9.27	8.24
132 87 20	20 cm Ø	12	1	11.30	10.17	9.04
132 87 24	24 cm Ø	12	1	13.50	12.15	10.80



Emaille Schalen Blue

		Stück	1	60	120	
				10 %	20 %	
132 84 16	16 x 12 cm, H: 3.5 cm	12	1	9.80	8.82	7.84
132 84 18	18 x 13.5 cm, H: 4 cm	12	1	11.30	10.17	9.04
132 84 20	20 x 15 cm, H: 4.5 cm	12	1	13.40	12.06	10.72



Emaille Mugs Blue

		Stück	1	60	120	
				10 %	20 %	
132 86 10	100 ml, 7 cm Ø, H: 5 cm	12	1	6.20	5.58	4.96
132 86 36	360 ml, 9 cm Ø, H: 8 cm	12	1	7.00	6.30	5.60
132 86 57	568 ml, 10 cm Ø, H: 9 cm	12	1	8.60	7.74	6.88



Emaille Schalen rund Blue

		Stück	1	60	120	
				10 %	20 %	
132 85 12	500 ml, 12 cm Ø, H: 6 cm	12	1	7.70	6.93	6.16
132 85 16	480 ml, 16 cm Ø, H: 4.3 cm	12	1	7.00	6.30	5.60



Emaille Schüssel mit Deckel

		Stück	1	60	120	
				10 %	20 %	
132 88 20	20 cm Ø, H: 12 cm	1	1	51.80	46.62	41.44



HOT STONE „I COOK“



premio *Star*

Hot-Stone "I cook" Set komplett

Komplettes Set besteht aus:

- 1 Bambus Brett, 40 x 28.8 cm, H: 2.5 cm
- 1 Hotstone, 20.9 x 14.8 cm, H 2.5 cm
- 1 CNS-Isolationsplatte
- 1 Porzellanschale weiss, 24 x 12 cm
- 3 Porzellan Bowls weiss, 7 cm Ø, H: 3.8 cm

Set nur
78.40



	Stück	1
240 30 00 Hot Stone "I cook" komplett	1	98.00 78.40

Table Top



Hot-Stone "I cook" Einzelteile

		Stück	1	60	120
240 30 53	Porzellan Bowl weiss, Ø 7 cm, H: 3.8 cm	1	1	3.50	2.63
240 30 52	Porzellan Schale weiss, 24 x 12 cm	1	1	13.00	9.75



Schüsseln eckig Terramesa

		Stück	1	60	120
138 97 13	(G), 13 x 13 cm, strohgelb	12	1	12.80	10.88
138 97 53	(G), 13 x 13 cm, olive	12	1	12.80	10.88
138 97 82	(G), 13 x 13 cm, sand	12	1	12.80	10.88
138 97 85	(G), 13 x 13 cm, braun	12	1	12.80	10.88



Dippschale rund Terramesa

		Stück	1	60	120
137 95 13	(G), 6.5 cm Ø, strohgelb	12	1	9.20	7.82
137 95 53	(G), 6.5 cm Ø, olive	12	1	9.20	7.82
137 95 82	(G), 6.5 cm Ø, sand	12	1	9.20	7.82
137 95 85	(G), 6.5 cm Ø, braun	12	1	9.20	7.82



Schalen rechteckig tief Terramesa

		Stück	1	60	120
137 93 13	(G), 25.5 x 13 cm, strohgelb	6	1	33.00	28.05
137 93 53	(G), 25.5 x 13 cm, olive	6	1	33.00	28.05
137 93 82	(G), 25.5 x 13 cm, sand	6	1	33.00	28.05
137 93 85	(G), 25.5 x 13 cm, braun	6	1	33.00	28.05



Pizzaofen Mini Plus 1

Einkammer-Pizzaofen aus Edelstahl, Boden aus hitzebeständigem Stein, Ober- und Unterhitze getrennt regelbar, mit Innenbeleuchtung, Temperatur bis 300°C
1 Backkammer: 41 x 37 cm, H: 9 cm (für 1 Pizza 35 cm Ø).
Auch zum Erwärmen von heissem Stein geeignet

		Stück	1	60	120
431 25 00	57 x 47 cm, H: 25 cm, 230 V, 2 kW, 20 kg	1	1		610.00





Muscheltopf schwarz

Emailliertes Stahlblech schwarz, mit Inox-Rand

Servierpfanne, nicht zum Kochen geeignet

		Stück		1
404 02 18	18 cm Ø, 2 l, H: 12 cm	1	1	18.00 14.40 20 %
404 02 20	20 cm Ø, H: 13 cm, 3 l	1	1	19.00 15.20
404 02 24	24 cm Ø, H: 13.5 cm, 4 l	1	1	20.00 16.00



ab
8.01

Minicasserole

Porzellan

		Stück	1	12	30
133 90 00	weiss, 10.2 cm Ø, H: 8 cm	1	1	8.90	8.46 5 %
133 90 45	rot, 10.2 cm Ø, H: 8 cm	1	1	8.90	8.46 5 %
133 90 99	schwarz, 10.2 cm Ø, H: 8 cm	1	1	8.90	8.46 5 %
133 91 00	weiss, 12.5 cm Ø, H: 9 cm	1	1	12.40	11.78 5 %
133 91 45	rot, 12.5 cm Ø, H: 9 cm	1	1	12.40	11.78 5 %
133 91 99	schwarz, 12.5 cm Ø, H: 9 cm	1	1	12.40	11.78 5 %



Mini Cocotten Gusseisen emailliert

rot/weiss, H: 8 cm

		Stück	1	12	30
404 00 45	rund, 10 cm Ø	1	1	24.00	19.20 20 %
404 01 45	oval, 12 x 8 cm	1	1	25.00	20.00 20 %



Mini Cocotten Gusseisen

schwarz, H: 8 cm

		Stück	1	12	30
404 00 99	rund, 10 cm Ø, H: 8 cm	1	1	24.00	19.20 20 %
404 01 99	oval, 12 x 8 cm, H: 8 cm	1	1	25.00	20.00 20 %



Cocotte Gusseisen rund

Hochwertiger Gusseisen-Cocotte mit Hochglanz-Emallierung. Für alle Herdarten, inkl. Induktion geeignet. Handwäsche empfohlen
schwarz, H: 7 cm, 0.8 l

		Stück	1	12	30
404 03 14	rund, 14 cm Ø	1	1	112.00	100.80 10 %



Servierpfannen

Geschmiedet mit gebogenem Hakenstiel, für Grilladen, Rösti, Schnitzel
Gebrauchsanweisung beachten!

		Stück	1	12	30
401 95 20	20 cm Ø	1	1	38.00	26.60 30 %
401 95 24	24 cm Ø	1	1	46.00	32.20 30 %
401 95 28	28 cm Ø	1	1	54.00	37.80 30 %
401 95 90	Korkuntersatz 22 cm Ø	1	1	20.00	14.00 30 %



Gusseisen-Servierpfanne oval

komplett mit Holzuntersetzer und Serviergriff (Griff kann abgenommen werden)

Holzuntersetzer 34 x 18.5 cm

		Stück	1	12	30
240 63 00	Gusseisen-Servierpfanne, 26 x 17 cm	1	1	26.00	20.80 20 %

Table Top

Gusseisen-Servierpfanne rund

komplett mit Holzuntersetzer und Serviergriff (Griff kann abgenommen werden)

Holzuntersetzer 27 x 23 cm

		Stück		1	20 %
240 62 00	Gusseisen-Servierpfanne, 22 cm Ø	1	1	26.00	20.80



20.80

Gusseisen-Servierpfanne mit Griff oval

komplett mit Holzuntersetzer

Holzuntersetzer 34 x 18cm

		Stück		1	20 %
240 64 00	Gusseisen-Servierpfanne, 24 x 17 cm	1	1	26.00	20.80



Gratin-/Eierplatte aus Gusseisen Suisse

mit Bambusbrett

		Stück		1	10 %
132 53 18	18 cm Ø, mit Griff 24 cm Ø	1	1	39.00	35.10



Pizzateller

Porzellan, weiss

		Stück		1	30 %
131 24 00	32.5 cm Ø	6	1	44.10	7.77



ab
7.77

Pizzateller

Porzellan mit einer reaktiven Glasur - Italien

		Stück	1	12	30	
131 50 00	33 cm Ø, weiss	6	1	12.10	10.89	9.68
131 50 30	33 cm Ø, weiss/terracotta	6	1	13.20	11.88	10.56



Kinderteller hulu Mouse

Porzellan, weiss

		Stück		1	25 %
134 20 00	24.5 x 27.5 cm	3	1	21.50	16.13



Pommesschalen Porzellan

Weisse Porzellan-Pommesschalen in coolem Einweg-Design

		Stück	1	12	30	
132 32 15	15 x 8 cm	48	1	5.20	4.68	4.16
132 32 20	19.6 x 11.2 cm	6	1	8.50	7.65	6.80
132 32 25	25.4 x 14.5 cm	6	1	10.60	9.54	8.48
132 32 36	35.5 x 22.8 cm	1	1	37.60	33.84	30.08





Valais-Teller

Porzellan, für Fondues Chinoise oder Bourguignonne etc.

		Stück	1	12	30
131 27 00	oval, 28 x 24 cm	6	1	15.00	12.00
				13.50	10.00
					20 %

ab
9.45



Fondue-Teller

Für Fondue Chinoise oder Bourguignonne etc.

		Stück	1	12	30
131 28 00	Porzellan, 23 cm Ø	6	1	13.50	9.45
131 28 28	Porzellan, 27.5 cm Ø	4	1	21.50	15.05



Grillspieß Herkules

Edelstahl 18/10, seidenmatt gebürstet, Vorrichtung zum Aufhängen, bewegliche Abstreifehilfe, gedrehte Spitze verhindert das Abgleiten des Grillguts spülmaschinengeeignet

		Stück	1	12	30
465 31 45	Länge: 45 cm, Klinglänge: 32 cm	4	1	9.40	7.52

ab
5.20



Olive Boat

Porzellan, weiss

		Stück	1	12	30
132 36 18*	18 x 8 cm	6	1	6.50	5.20
				5.85	5.20
					20 %



Schalen

		Stück	1	36	72
134 37 18	Schale Pagode, 18 x 8 cm, H: 5 cm	6	1	10.70	8.56
134 37 26	Schale Pagode, 22.5 x 11 cm, H: 7 cm	4	1	19.90	15.92
136 06 14	Ess Schale, 14 x 10 cm, H: 5 cm	6	1	5.80	4.64



Schalen Teardrops

		Stück	1	36	72
134 23 09*	9 x 5.4 cm, H: 3.5 cm	6	1	5.80	4.64
134 23 19*	19 x 11.5 cm, H: 6 cm	6	1	13.40	10.72
134 23 25	25 x 14.5 cm, H: 7.5 cm	6	1	21.50	17.20
134 23 32	32 x 17 cm, H: 7.5 cm	6	1	31.30	25.04



Teller Retangolo

Porzellan, weiss

		Stück	1	12	30
132 35 13	13 x 6 cm	6	1		4.90
132 35 28	29 x 12 cm	6	1		9.30
132 35 37	37 x 15 cm	6	1		16.90



Miniconcept Tapas Dosen

Dosenlook neu im Trend - Foodpräsentation einmal anders. Wiederverwendbar, Dosen aus Stahlblech, spülmaschinengeeignet.

Bronzefarbig

		Stück	1	12	24
240 80 09	rund, 8 cm Ø, H: 4.5 cm	1	10	16.20	14.58
240 80 11	oval, 11 x 7 cm, H: 6 cm	1	10	11.90	10.71

Table Top

Dim Sum Bambus Dämpfer

3-teilig, bestehend aus 2 Körben und 1 Deckel

		Stück	1	12	30
				10 %	20 %
241 90 15	15 cm Ø, H: 13 cm	1	1	18.80	16.92
241 90 20	20 cm Ø, H: 15 cm	1	1	25.20	22.68



Terracotta Mediterran

Die ofenfesten Terracotta Formen sind ideal zum Servieren von Tapas, Oliven und Antipasti oder den typischen Nachspeisen wie Crème Brûlée und Crema Catalana. Den Einsatzgebieten sind keine Grenzen gesetzt.

		Stück	1		
132 46 12	11.5 cm Ø	12	1		3.20
132 46 13	13 cm Ø	12	1		3.60
132 47 17	Ø 17, mit Griff	5	1		6.00
132 46 08	8 cm Ø	12	1		2.80



Gourmetplatten rund

		Stück	1	24	48
				10 %	20 %
132 00 13	12.5 cm Ø, Aussen Ø: 15 cm	6	1	6.90	6.21
132 00 16	15.5 cm Ø, Aussen Ø: 18 cm	6	1	7.50	6.75
132 00 17	17 cm Ø, Aussen Ø: 20 cm	6	1	9.40	8.46
132 00 20	20 cm Ø, Aussen Ø: 24.5 cm	4	1	11.50	10.35



Gourmetplatten oval

		Stück	1	24	48
				10 %	20 %
132 16 22	21.5 x 11.6 cm	6	1	4.90	4.41
132 16 27	26.5 x 14.5 cm	6	1	6.80	6.12
132 16 32	32 x 16.5 cm	6	1	9.90	8.91



ab
3,92

Schalen Pasta

		Stück	1	24	48
				10 %	20 %
135 20 23	H: 5 cm, 23 x 16 cm	6	1	11.00	9.90
135 20 26	H: 5.5 cm, 25.5 x 17 cm	6	1	12.40	11.16



ab
8,80

Pastateller

Hotelporzellan, die Hartglasur garantiert eine lange Lebensdauer

		Stück	1		
				50 %	
130 92 24	25 cm Ø, Piccolo	6	1	15.80	7.90
130 92 27	27 cm Ø, Medio	6	1	17.80	8.90
130 92 30	30 cm Ø, Grande	6	1	19.80	9.90



Platten oval Parma

Starkes Porzellan mit optimaler Wärmespeicherung

		Stück	1		
				30 %	
131 25 02	23 x 15 cm, H: 3.5 cm	6	1	10.10	7.07
131 25 03	28 x 19 cm, H: 4 cm	6	1	13.00	9.10
131 25 06	34 x 23 cm, H: 5 cm	6	1	21.00	14.70



ab
7,07



Bowl Taste Tulip - Steelite Porzellan

		Stück	1	60	120
137 05 01	(G) 10 cm Ø	12	1	6.90	5.87
137 05 02	(G), 14 cm Ø	12	1	8.20	6.97
137 05 03	(G), 17.5 cm Ø	12	1	11.10	9.44
137 05 04	(G), 21.5 cm Ø	6	1	26.50	22.53



Schüsseln Vogue - Steelite Porzellan

		Stück	1	60	120
137 04 45	10 cm Ø	12	1	6.90	5.87
137 04 46	13 cm Ø	12	1	9.30	7.91



Löwenkopf Suppenterrinen

		Stück	1	60	120
131 20 03	8.7 cm Ø, 0.35 l	6	1	6.60	4.62
131 20 04	9.5 cm Ø, 0.4 l	6	1	7.00	4.90
131 20 10*	15.5 cm Ø, 1.3 l	4	1	16.00	11.20



Schälchen oder Schüsseln Vitale

		Stück	1	60	120
130 83 02	H: 4.5 cm, 9.2 cm Ø	6	1	5.30	4.24
130 83 05	H: 7.5 cm, 13 cm Ø	6	1	7.40	5.92



Schalen oder Schüsseln Practico

weiss, für Saucen, Salate, Suppen und als Kafi-Chacheli, Porzellan

		Stück	1	36	60
131 90 09	1.5 dl, H: 5 cm, 8.5 cm Ø	12	1	5.90	5.31
131 90 13	5 dl, H: 7 cm, 13 cm Ø	6	1	6.70	6.03
131 90 14	6.5 dl, H: 7.5 cm, 14 cm Ø	6	1	7.50	6.75



Schälchen oder Schüssel Piano

Sieht optisch sehr gross aus, hat aber den Inhalt einer normalen Bouillon-Tasse

		Stück	1	36	60
131 19 07	Schälchen, H: 2.3/3 cm, 7.2 cm Ø	6	1	4.90	3.43
131 12 04	Schüssel, 0.38 l, 19 cm Ø	6	1	11.40	7.98



Schüsseln Porzellan

		Stück	1	12	24
131 06 25	orange, 15.2 cm Ø, H: 8.5 cm, 8 dl	6	1	13.40	12.06
131 06 51	apfelgrün, 15.2 cm Ø, H: 8.5 cm, 8 dl	6	1	13.40	12.06
131 06 65	blau, 15.2 cm Ø, H: 8.5 cm, 8 dl	6	1	13.40	12.06
131 06 95	grau, 15.2 cm Ø, H: 8.5 cm, 8 dl	6	1	13.40	12.06
131 07 11	Fantasy blau, 8.5 cm Ø, H: 6 cm, 3 dl	6	1	6.40	5.76
131 07 15	Fantasy blau, 15 cm Ø, H: 8 cm, 7 dl	6	1	12.70	11.43
131 07 20	Fantasy blau, 20 cm Ø, H: 10 cm, 1.8 l	6	1	20.00	18.00

Table Top

Buffetschüssel Party

Porzellan, weiss, ovale Form

		Stück	1	12	30
				10 %	20 %
134 40 25	25 x 16 cm, H: 9 cm	6	16.50	14.85	13.20
134 40 30	30 x 19.5 cm, H: 11 cm	6	28.10	25.29	22.48
134 40 35	35 x 23 cm, H: 13 cm	6	39.70	35.73	31.76



Saucieren Teardrops

		Stück	1	36	72
				10 %	20 %
131 35 02	Mini, 0.8 dl, H: 4.4 cm, 8 cm Ø	12	3.50	3.15	2.80
132 17 25	2.5 dl, 14 x 8.5 cm	6	8.50	7.65	6.80



Sauciere mit Unterteller

Porzellan, weiss

		Stück	1	12	30
				10 %	20 %
132 15 15	17 x 12 cm, 1.5 dl	6	11.50	10.35	9.20



Saucieren CNS ohne Fuss

Stapelbar, CNS 18/10, poliert

		Stück	1	12	1
				20 %	20 %
270 24 05	0.5 dl, H: 3 cm, 14 x 6.5 cm	1	1	16.00	12.80
270 24 10	1 dl, H: 3 cm, 15.5 x 7.4 cm	1	1	19.80	15.84
270 24 20	2 dl, 19 x 9 cm, H: 5 cm	1	1	24.90	19.92



Saucieren CNS LUX

Stapelbar, CNS 18/10, hochglanzpoliert

		Stück	1	12	1
				15 %	15 %
270 25 14*	1.4 dl, 15.8 x 7.5 cm, H: 9.5 cm	1	1	28.00	23.80
270 25 25*	2.5 dl, 19 x 8.9 cm, H: 10 cm	1	1	32.00	27.20
270 25 42*	4.2 dl, 22.5 x 10.5 cm, H: 11.5 cm	1	1	46.00	39.10



Saucieren CNS

CNS 18/8, hochglanzpoliert, extra schwere Qualität

		Stück	1	12	1
				20 %	20 %
270 14 15	1.5 dl, 16 x 7.5 cm, H: 9 cm	1	1	9.00	7.20
270 14 25	2.5 dl, 19 x 9 cm, H: 13 cm	1	1	12.00	9.60
270 14 45	4.5 dl, 22 x 10.5 cm, H: 13.5 cm	1	1	15.00	12.00



Eierbecher

		Stück	1	12	30
				10 %	20 %
131 41 00	8.5 cm Ø, Porzellan	6	5.30	4.77	4.24
131 41 01	8.6 cm Ø, CNS	12	3.20	2.88	2.56
131 41 06	6 cm Ø, Porzellan	6	5.10	4.59	4.08



Eierlöffel

		Stück	1	12	1
				30 %	30 %
152 10 00	14.5 cm, Polystyrol	1	100	54.00	37.80



premio *Star*



TOP

Piano Kaffee-Serie

Die moderne Tassen-Serie mit angenehmem Henkel ist stapelbar. Die abgeschrägten Unterteller erleichtern den Service. Design brunelli

premio *Star*



Tassen Piano

		Stück		1	
131 14 10	Espresso-Obertasse, 0.09 l	6	1	5.90	4.13
131 15 13	Espresso-Untertasse, 12.5 cm Ø	6	1	3.90	2.73
131 14 20	Kaffee-Obertasse, 0.2 l	6	1	6.50	4.55
131 14 30	Milchkaffee-Obertasse, 0.27 l	6	1	7.80	5.46
131 15 15	Kaffee-Untertasse zu 131 14 30/131 14 20, 15 cm Ø	6	1	4.40	3.08
131 17 21	Untertasse mit Ablage zu 31 14 30/131 14 20, 21 x 13.3 cm	6	1	7.90	5.53
		Stück	1	60	120
160 00 00	Wasserbecher, 90 ml, 58 mm Ø, H: 70 mm	24	1	1.00	0.90
				10 %	20 %

Table Top



Linea Kaffee-Serie stapelbar

Linea die neue stapelbare Tassen-Serie – elegant und ansprechend im Design, ohne Stapelrand. Die sich nach oben öffnende Form der Tassen ergibt optisch mehr Inhalt. Die runden Untertassen haben den idealen Rand für einen einfachen, sicheren Service. Die Untertasse mit Ablage passt zu allen 3 Tassengrößen. Ideal zum Mitservieren von Wasser, Crémier, Teebeutel. Design brunelli

Tassen Linea

		Stück	1	60	120
131 96 10	Espresso-Obertasse, 0.09 l	6	1	6.80	4.76
131 97 13	Espresso-Untertasse, 13 cm Ø	6	1	4.20	2.94
131 96 20	Kaffee-Obertasse, 0.2 l	6	1	7.90	5.53
131 96 27	Milchkaffee-Obertasse, 0.27 l	6	1	8.80	6.16
131 97 15	Kaffee-Untertasse zu 131 96 20/131 96 27, 15 cm Ø	6	1	4.90	3.43
131 98 22	Untertasse mit Ablage zu 131 96 10/ 131 96 20/131 96 27, 22 x 13.3 cm	6	1	8.90	6.23
		Stück	1	60	120
160 02 16	Wasserglas, 160 ml, H: 100 mm, 51 mm Ø	12	1	1.10	0.99
				10 %	20 %



Mini Teller Linea zu Tassen

Die Mini-Teller passen auf die Espresso- und Milchkaffee/Tee-Tassen. Als Deckel halten Sie Kaffee oder Teewasser warm. Ideal zum Mitservieren von Teebeutel, Biscuits etc. Auch als "Häppchen-Teller" alleine zu verwenden.

		Stück	1	60	120
131 99 07	für 131 96 10, 7 cm Ø	6	1	2.40	1.47
131 99 09	für 131 96 20/ 131 96 27, 9 cm Ø	6	1	2.50	1.75





**TOP
Barista**

Tassen und Untertassen LiV Steelite



		Stück	1	60	120	
137 03 80	(G), Espresso-Obertasse, 0.85 dl	12	1	5.50	4.68	4.13
137 03 78	(G), Espresso-Untertasse, 12.5 cm Ø	12	1	4.00	3.40	3.00
137 03 81	(G), Kaffee-Obertasse, 1.7 dl	12	1	6.00	5.10	4.50
137 03 82	(G), Kaffee-Obertasse, 2.25 dl	12	1	6.30	5.36	4.73
137 03 83	(G), Kaffee-Obertasse, 2.85 dl	12	1	8.00	6.80	6.00
137 03 84	(G), Milchkaffee-Obertasse, 3.5 dl	12	1	8.40	7.14	6.30
137 03 85	(G), Milchkaffee-Obertasse, 4.55 dl	12	1	10.10	8.59	7.58
137 03 79	(G), Kaffee-Untertasse, 15 cm Ø	12	1	4.80	4.08	3.60

Tasse Sheer - Steelite Porzellan



		Stück	1	60	120	
137 01 22	(G), Espresso Obertasse, 0.09 l	12	1	7.40	6.29	5.55
137 02 83	(G), Espresso Untertasse, 12 cm Ø	12	1	4.70	4.00	3.53
137 01 23	(G), Kaffee Obertasse, 0.23 l	12	1	8.70	7.40	6.53
137 02 84	(G), Kombi-Untertasse, 15.3 cm Ø	12	1	5.10	4.34	3.83

Quench Mug Simplicity - Steelite Porzellan



		Stück	1	60	120	
137 00 01	(G), Espresso Obertasse, 0.08 l	6	1	5.70	4.85	4.28
137 00 02	(G), Kaffee Obertasse, 0.22 l	12	1	8.00	6.80	6.00
137 00 03	(G), Kaffee Obertasse, 0.28 l	12	1	8.40	7.14	6.30
137 00 04	(G), Milch Obertasse, 0.34 l	12	1	8.80	7.48	6.60
137 00 05	(G), Milch Obertasse, 0.45 l	12	1	10.50	8.93	7.88

Tassen Aroma - Steelite Porzellan



		Stück	1	60	120	
137 00 59	(G), Espresso-Obertasse stap., 0.085 l	6	1	5.70	4.85	4.28
137 00 52	(G), Espresso Untertasse 12 cm Ø	12	1	3.60	3.06	2.70
137 00 58	(G), Kaffee-Obertasse stap. 0.19 l	6	1	7.30	6.21	5.48
137 00 53	(G), Kombi Untertasse 15 cm Ø	12	1	4.10	3.49	3.08

Table Top

Tassen Classico Italia

Porzellan, weiss, klassische, italienische Form

		Stück	1	36	72
				10 %	20 %
131 92 01	Espresso-Obertasse, 0.85 dl	6	1	3.90	2.34
131 92 12	Espresso-Untertasse, 12 cm Ø	6	1	2.70	1.62
131 92 02	Kaffee-Obertasse, 1.8 dl	6	1	5.50	3.30
131 92 14	Kaffee-Untertasse, 14 cm Ø	6	1	3.60	2.16
131 92 03	Milchkaffee-Obertasse, 3.2 dl	6	1	6.60	3.96
131 92 16	Milchkaffee-Untertasse, 16 cm Ø	6	1	4.40	2.64



Tassen und Untertassen Meridi

Aus New Bone China-Porzellan gefertigt

		Stück	1	36	72
				10 %	20 %
134 038 09	Espresso-Obertasse, 9.5 cl	12	1	6.40	4.48
134 038 11	Espresso-Untertasse, 11.5 cm Ø	12	1	4.90	3.43
134 038 21	Kaffee-Obertasse, 21 cl	12	1	8.40	5.88
134 038 14	Kaffee-Untertasse, 14.5 cm Ø	6	1	5.60	3.92



Knitterbecher Porzellan

		Stück	1	36	72
				10 %	20 %
131 53 10	Knittercher small, 0.1 l, H: 7.5 cm	6	1	5.10	4.08
131 53 30	Knitterbecher medium, 0.27 l, H: 10.8 cm	6	1	5.30	4.24



Becher/Mug

		Stück	1	36	72
				10 %	20 %
131 52 30	H: 9 cm, 8.1 cm Ø, 0.29 l, Mug	6	1	3.90	3.12



Tassen mit Untertassen Mara color

		Stück	1	36	60
				10 %	20 %
131 85 25	orange, Espresso- mit Untertasse	6	1	13.29	7.44
131 85 45	rot, Espresso- mit Untertasse	6	1	13.29	7.44
131 85 55	grün, Espresso- mit Untertasse	6	1	13.29	7.44
131 85 99	schwarz, Espresso- mit Untertasse	6	1	13.29	7.44
131 86 25	orange, Kaffee- mit Untertasse	6	1	17.00	9.52
131 86 45	rot, Kaffee- mit Untertasse	6	1	17.00	9.52
131 86 55	grün, Kaffee- mit Untertasse	6	1	17.00	9.52
131 86 99	schwarz, Kaffee- mit Untertasse	6	1	17.00	9.52



Kaffeebereiter Chamboard Bodum

Der CHAMBORD Kaffeebereiter mit dem Bodum typischen French Press System für den vollmundigen und besonderen Kaffee Genuss. Aus geschmacksneutralem und hitzebeständigem Borosilikatglas. Mit Klappmechanismus im Deckel. Filter aus Edelstahl. Für 3 Tassen

		Stück	1	36	72
				10 %	20 %
141 19 35	chrom, 0.35 l	4	1	49.90	39.92
141 19 36	kupfer, 0.35 l	4	1	49.90	39.92





Alta Espresso weiss

			Stück	1	60	120
133 50 00	Espresso-Obertasse, 0.08 l	6	1	6.50	5.85	5.20
133 51 00	Espresso-Untertasse, 13 cm Ø	6	1	4.90	4.41	3.92



Alta Cappuccino weiss

			Stück	1	60	120
133 52 00	Cappuccino-Obertasse, 0.18 l	6	1	8.30	7.47	6.64
133 53 00	Cappuccino-Untertasse, 14.7 cm Ø	6	1	5.50	4.95	4.40



Alta Café weiss

			Stück	1	60	120
133 54 00	Café Obertasse, 0.28 l	6	1	11.30	10.17	9.04
133 55 00	Café Untertasse, 15.8 cm Ø	6	1	7.40	6.66	5.92



Assam Teebereiter Bodum

Das typische Bodum Press Filter System sorgt für einen besonders aromatischen Tee. Aus geschmacksneutralem und hitzebeständigem Borosilikatglas. Der grosse Filter bietet den Teeblättern besonders viel Platz, um das Aroma noch besser zu entfalten.

			Stück	1	20 %
141 22 50	chrom, 0.5 l	6	1	49.90	39.92



penStar

Teekrug Chado

Der Klassiker - für die perfekte Teezeremonie

Schöner Teekrug aus Gusseisen emailiert nach japanischer Traditionen gefertigt, inklusive CNS-Sieb

Nicht spülmaschinengeeignet

			Stück	1	40 %
133 25 03	Teekrug 0.3 l	1	1	48.00	28.80
133 25 06	Teekrug 0.6 l	1	1	59.00	35.40
133 25 10	Teekrug 1.2 l	1	1	79.00	47.40
			Stück	1	
133 25 56	Ersatzersatz zu 133 25 06	1	1		2.40
133 25 53	Ersatzersatz zu 133 25 03	1	1		2.40
133 25 60	Ersatzersatz zu 133 25 10	1	1		2.80



penStar

Teekrug Chado green

Gusseisen emailiert, inklusive CNS-Sieb. Nicht spülmaschinengeeignet

			Stück	1	40 %
133 24 03	Teekrug 0.3 l	1	1	48.00	28.80
133 23 06	Teekrug 0.6 l	1	1	59.00	35.40
			Stück	1	
133 25 53	Ersatzersatz zu 133 24 03	1	1		2.40
133 25 56	Ersatzersatz zu 133 23 06	1	1		2.40

Table Top

Serviertablett Holz

	Stück			1
282 13 26 26 x 16 cm, H: 2 cm, schwarz	1	1	14.90	11.92 20 %



Serviertablett CHIC

Serviertablett in Kunstleder, Kroko-Optik braun, antirutsch

	Stück			1
281 80 00 36 x 22.5 cm, Kroko braun	1	1	46.00	36.80 20 %
281 81 00 Kroko braun, 52 x 35 cm	1	1	62.00	49.60



Serviertablett CHIC

Holztablett mit dunkelbraunem Kunstleder, antirutsch

	Stück			1
281 82 85 braun, 25 x 25 cm	1	1	43.60	34.88 20 %
281 83 85 braun, 28 x 16 cm	1	1	38.00	30.40
281 84 85 braun, 53 x 16 cm	1	1	60.00	48.00
281 85 85 braun, 42.5 x 32.5 cm	1	1	59.00	47.20



Serviertablett CHIC

Holztablett mit schwarzem Kunstleder, antirutsch

	Stück			1
281 82 99 schwarz, 25 x 25 cm	1	1	43.60	34.88 20 %
281 83 99 schwarz, 28 x 16 cm	1	1	38.00	30.40
281 84 99 schwarz, 53 x 16 cm	1	1	60.00	48.00
281 85 99 schwarz, 42.5 x 32.5 cm	1	1	59.00	47.20



Serviertablett CHIC

Serviertablett in Kunstleder, Kroko-Optik

	Stück			1
281 86 99 Kroko schwarz, 41 x 26 cm	1	1	69.50	55.60 20 %



Melamintablett mit Holzoptik

	Stück	1	6	12
270 57 26 Holzoptik, weiss, 26.5 x 16.2 cm	1	1	21.00	18.90 10 %
270 57 27 Holzoptik, schwarz, 26.5 x 16.2 cm	1	1	21.00	18.90 10 %
270 57 35 Holzoptik, weiss, 26.5 x 16.2 cm	1	1	31.00	27.90 10 %
270 57 27 Holzoptik, schwarz, 26.5 x 16.2 cm	1	1	31.00	27.90 10 %





ab
21.53

Teekrug Harmony - Steelite Porzellan

Teekrug ohne Siebeinsatz, kann separat bestellt werden

		Stück	1	60	120
137 00 92	Teekrug 0.6 l	1	1	28.70	21.53
137 00 93	Ersatzzeinsatz zu 137 00 92	12	1	9.90	7.43
				15 %	25 %



Tee-Set Chic

		Stück	1	30 %
133 30 00*	Teekrug 2.5 dl, Deckel, Tasse, Untertasse	1	1	15.40
				22.00



Teegläser

		Stück	1	60	120
162 19 25	Louison, 250 ml, H: 11.3 cm, 8.4 cm Ø	6	1	6.00	4.80
162 20 27	Feuille de Thé, 270 ml, H: 11.5 cm, 8.8 cm Ø	6	1	6.00	4.80



Teebecher

		Stück	1	72	144
140 90 00	Teebecher Rum, 230 ml, H: 10.5 cm, 7.5 cm Ø	6	1	2.40	1.92
140 92 00	Stapeltasse, 250 ml, H: 9 cm, 7 cm Ø	6	1	1.50	1.20
140 98 03	New Morning, 320 ml, H: 10.6 cm	6	1	1.90	1.52



Teegläser

		Stück	1	72	144
140 93 00	Teebecher Universel, 220 ml, H: 8.9 cm, 7.3 cm Ø	6	1	1.30	1.04
140 64 03	Teebecher Viva, 310 ml, H: 10 cm, 9 cm Ø	12	1	3.00	2.40
140 91 00	Arcoroc, 290 ml, H: 14 cm, 7.5 cm Ø	4	1	3.70	2.96



Teeglas Kenia

		Stück	1	60	120
141 08 31	Kenia, 320 ml, H: 10.3 cm, 8 cm Ø	6	1	3.90	3.12
				10 %	20 %



Teeglas Lyra

aus Borosilikatglas

		Stück	1	60	120
141 14 40	400 ml, H: 120 mm, 85 mm Ø	4	1	5.70	4.56
				10 %	20 %



Teebeutel-/Konfischälchen

		Stück	1	12	30
140 95 00	Glasschälchen , 6 cm Ø, H: 2.5 cm	6	1	0.70	0.56
131 19 07	Piano, 7.2 cm Ø, H: 2.3/3 cm	6	1	4.90	3.43
				10 %	20 %
					30 %

Table Top

Wasserbecher

Wasserglas als Begleiter zum Espresso oder Kaffee.

		Stück	1	60	120	
				10 %	20 %	
160 00 00	Wasserbecher, 90 ml, 58 mm Ø, H: 70 mm	24	1	1.00	0.90	0.80
160 02 16	H: 100 mm, 51 mm Ø, 160 ml	12	1	1.10	0.99	0.88



Kaffeeglas Original

		Stück	1	60	120	
				10 %	20 %	
170 71 20	66 mm Ø, H: 143 mm, 200 ml, Original	12	1	2.10	1.89	1.68



Glas-Tassen Kenia

		Stück	1	60	120	
				10 %	20 %	
141 08 08	Espresso-Obertasse, 80 ml, 5.8 cm Ø, H: 5.5 cm	6	1	2.30	2.07	1.84
141 08 25	Kaffee-Obertasse, 245 ml, H: 80 mm, 87 mm Ø	6	1	2.70	2.43	2.16
141 15 11	Espresso-Untertasse, 11 cm Ø	6	1	1.70	1.53	1.36
141 15 15	Kaffee-Untertasse, 15 cm Ø	6	1	2.20	1.98	1.76



Latte Macchiato-Gläser

		Stück	1	60	120	
				10 %	20 %	
141 08 00	Acapulco, 78 mm Ø, H: 148 mm, 280 ml	12	1	3.20	2.88	2.56
141 08 28	Latte Macchiato, 78 mm Ø, H: 148 mm, 280 ml	12	1	4.50	4.05	3.60
141 10 04	Assam, 90 mm Ø, H: 160 mm, 400 ml	2	1	48.50		12.95



Latte Macchiato-Gläser

		Stück	1	60	120	
				10 %	20 %	
171 25 02	Old Fashion 27, 78 mm Ø, H: 143 mm, 390 ml	6	1	2.20	1.98	1.76
170 45 36	83 mm Ø, H: 120 mm, 350 ml	12	1	1.90	1.71	1.52
170 79 34	Barista, 79 mm Ø, H: 160 mm, 340 ml	6	1	3.90	3.51	3.12



Coupe-/Macchiato-Löffel

		Stück	1	72	
				10 %	
151 93 00	18 cm, CNS, Normal	12	1	1.80	1.62
151 92 01	17.5 cm, CNS, Spezial	12	1	3.70	3.33
151 10 42	Luzern, 21 cm, Siruplöffel	12	1	3.50	2.80



Coupe-/Macchiato-Löffel

		Stück	1	72	
				40 %	
150 15 42	Verdi, CNS 18/10, 18.5 cm	12	1	6.20	3.72



3.72

profiStar



Tee-Box CHIC

Tee-Box in Kunstleder, Kroko-Optik braun, mit 6 Teebeutelächer (ohne Inhalt)

		Stück	1	30	60
260 67 86	Kroko braun, 24 x 18.5 cm, H: 6.5 cm	1	1	62.00	49.60

Crémier

Porzellan, weiss



		Stück	1	30	60
133 31 03	0.3 dl	24	1	1.30	1.04
133 31 04	0.4 dl	6	1	3.80	3.04
133 31 15	1.5 dl	12	1	3.00	2.40
133 31 28	2.8 dl	6	1	6.20	4.96

profiStar



Crémier Zylindro

Porzellan, weiss

		Stück	1	30	60
133 36 18	0.18 dl	1	2.40	2.16	1.92



Crémier CNS

		Stück	1	30	60
133 34 28	0.28 dl	1	4	21.00	4.85



Tee-Sieb mit Untersatz, CNS 18/10

		Stück	1	30	60
131 56 00	15.5 cm, 7 cm Ø	1	1	12.70	11.43



Zuckerbehälter

Porzellan weiss. Für Zucker- und Assugrin-Beutel.

		Stück	1	30	60
133 31 02	H: 4.5 cm, 11.8 x 7.2 cm	12	1	7.80	5.46



Zitronenpresse Erka

Presst den kleinen Zitronenschnitt ohne Kraftanstrengung und Spritzer optimal aus. Die praktische Zitronenpresse ist aus hochwertigem SAN-Glas mit CNS-Scharnier gefertigt.

		Stück	1	12	30
140 97 00	Zitronenpresse	1	1	7.90	7.11



Zitronenpresse CNS

		Stück	1	12	30
140 96 00	Zitronenpresse CNS	1	1	2.00	1.80

Table Top

Bodum - Doppelwandige Borosilikatgläser

Doppelwandiges Borosilikatglas von BODUM mit isolierender Wirkung für heiße und kalte Getränke sowie Desserts und Fingerfood.

- Aus doppelwandigem Borosilikatglas für bessere Isolierleistung: heiße Getränke bleiben länger heiß und kalte länger kalt
- Keine Verbrennungsgefahr für die Finger bei heißen Getränken - auch ohne Henkel
- Das Glas "atmet" und bildet keine Kondensierung auf der Glasoberfläche bei Kaltgetränken - es hinterlässt somit keine unschönen Wasserkränze
- Das Glas ist mundgeblasen

Die doppelwandigen Gläser von BODUM aus geschmacksneutralem Borosilikatglas sind leicht und gleichzeitig robust. Unter dem Glasboden befindet sich eine hydrophobe Silikon-Membran, die dem Druckausgleich zwischen den Glaswänden dient.

Glas Canteen

Doppelwandiges Borosilikatglas mit isolierender Wirkung für heiße und kalte Getränke sowie Desserts und Fingerfood

		Stück		1
141 16 01	Canteen, 100 ml, H: 73 mm, 72 mm Ø	2	1	10.60 7.42
				30 %



Glas Pilatus

Doppelwandiges Borosilikatglas mit isolierender Wirkung für heiße und kalte Getränke sowie Desserts und Fingerfood

		Stück		1
141 17 01	H: 65 mm, 62 mm Ø, Pilatus, 80 ml	2	1	11.60 8.12
				30 %



Glas Assam

Doppelwandiges Borosilikatglas mit isolierender Wirkung für heiße und kalte Getränke sowie Desserts und Fingerfood

		Stück		1
141 10 01	Assam, 100 ml, H: 72 mm, 67 mm Ø	2	1	10.60 7.42
141 10 03	Assam, 250 ml, H: 115 mm, 84 mm Ø	12	1	13.50 9.45
141 10 04	Assam, 400 ml, H: 160 mm, 90 mm Ø	2	1	18.50 12.95
141 10 02	Assam, 200 ml, H: 99 mm, 86 mm Ø	12	1	12.50 8.75



Glas Pavina

Doppelwandiges Borosilikatglas mit isolierender Wirkung für heiße und kalte Getränke sowie Desserts und Fingerfood

		Stück		1
141 11 01	Pavina, 80 ml, H: 65 mm, 60 mm Ø	2	1	10.60 7.42
141 11 04	Pavina, 350 ml, H: 116 mm, 88 mm Ø	2	1	15.30 10.71
141 11 03	Pavina, 250 ml, H: 89 mm, 88 mm Ø	2	1	13.50 9.45





Bistro - Spiegelau

Trendig und zeitgemäss kommt die neue Serie Bistro von Spiegelau daher. Die schlichte, einfache Serie passt sehr gut zum heutigen Trend der Bistronomie, wo qualitätsvolle Speisen in lockerer und ungezwungener Atmosphäre aufgetischt werden.

Die Teile sehen nicht nur gut aus, sondern sind auch noch funktionell, da stapelbar und eignen sich daher bestens für den Bistronomie-Bereich im Trendlokal, auch für Catering und Hotellerie, Kantinen und Schulen.



Mini Tumbler Bistro

stapelbar

		Stück		1
160 47 09	95 ml, H: 7 cm, 6 cm Ø	12	1	2.90 2.32
160 47 20	200 ml, H: 8.5 cm, 7.6 cm Ø	12	1	3.70 2.96



Tumbler Bistro

stapelbar

		Stück		1
160 47 20	200 ml, H: 8.5 cm, 7.6 cm Ø	12	1	3.70 2.96



Bowl Bistro

stapelbar

		Stück		1
140 23 13	415 ml, H: 4.7 cm, 13.4 cm Ø	12	1	3.70 2.96
140 23 14	605 ml, H: 6.2 cm, 14 cm Ø	12	1	4.90 3.92



Bowl "L" Bistro

stapelbar

		Stück		1
140 23 14	605 ml, H: 6.2 cm, 14 cm Ø	12	1	4.90 3.92



Glasteller Bistro

stapelbar

		Stück		1
140 22 22	22 cm Ø, H: 2 cm	12	1	4.90 3.92

Table Top

Glasteller Bossa Nova

		Stück		1
				30 %
140 15 23	23 cm Ø	6	1	9.90 5.94
140 15 32	32 cm Ø	6	1	19.80 11.88



Glasteller Jazz

		Stück		1
				30 %
140 13 32	32 cm Ø	6	1	19.80 13.86



Glasteller Rumba

		Stück		1
				30 %
140 12 23	23 cm Ø	6	1	9.90 6.93
140 12 32	32 cm Ø	6	1	19.80 13.86



Glasteller Mambo

		Stück		1
				30 %
140 11 23	23 cm Ø	6	1	9.90 6.93
140 11 32	32 cm Ø	6	1	19.80 13.86



Glasschale Mambo

		Stück		1
				30 %
140 11 25	25 cm Ø	2	1	19.80 13.86



Untersetzer/Brotteller Kristallglas

		Stück		1
				30 %
140 15 15	Bossa Nova, 15 cm Ø	4	1	8.50 5.95
140 16 15	Rumba, 15 cm Ø	4	1	8.50 5.95



Glasteller rechteckig Bossa Nova

		Stück		1
				30 %
140 15 28	28 x 14 cm	6	1	18.00 12.60





Circle

		Stück	1	36
177 30 32	32 cm	4	6.30	5.04
177 30 24	24.5 cm	6	5.30	4.24
177 45 16	16 x 12 cm, Schale tief	6	2.70	2.16



Glasschalen Quadro

		Stück	1	48	96
140 75 08	8 x 8 cm, H: 4.5 cm	24	5.30	4.77	4.24
140 75 11	10.5 x 10.5 cm, H: 6.2 cm	24	6.40	5.76	5.12



Glasschalen Niçoise

		Stück	1	12	30
143 06 12	12 cm Ø, H: 6.7 cm	6	1.80	1.62	1.44
143 06 15	15 cm Ø, H: 8.3 cm	4	4.00	3.60	3.20
143 06 18	18 cm Ø, H: 9.8 cm	6	4.70	4.23	3.76
143 06 21	21 cm Ø, H: 11.6 cm	6	4.80	4.32	3.84
143 06 24	24 cm Ø, H: 13.2 cm	4	5.80	5.22	4.64
143 06 28	28 cm Ø, H: 15.3 cm	4	9.30	8.37	7.44



Glasschüssel Empilable

		Stück	1	12	30
140 95 00	6 cm Ø, H: 2.5 cm	6	0.70	0.63	0.56
140 95 08	7.5 cm Ø, H: 3 cm, Glasschälchen	6	0.80	0.72	0.64
140 74 12	12 cm Ø, H: 5.5 cm, Schüssel	6	1.10	0.99	0.88
140 74 14	14 cm Ø, H: 6 cm, Schüssel	6	1.70	1.53	1.36
140 74 20	20 cm Ø, H: 9 cm	6	3.40	3.06	2.72
140 74 23	23 cm Ø, H: 10.5 cm	6	4.40	3.96	3.52
140 74 26	26 cm Ø, H: 12 cm	6	6.60	5.94	5.28



Glasschalen Mr. Chef

		Stück	1	12	30
140 73 09	9 cm Ø, H: 3.8 cm	6	1.60	1.44	1.28
140 73 11	11 cm Ø, H: 4.8 cm	6	2.20	1.98	1.76
140 73 14	14 cm Ø, H: 6 cm	6	2.90	2.61	2.32
140 73 17	17 cm Ø, H: 9.5 cm	6	5.50	4.95	4.40
140 73 22	22 cm Ø, H: 11.2 cm	6	7.90	7.11	6.32
140 73 26	26 cm Ø, H: 12.6 cm	6	10.90	9.81	8.72



Glasschüssel Viva

		Stück	1	12	30
140 63 14	14 cm Ø, H: 6.5 cm	6	2.90	2.61	2.32
140 63 20	20 cm Ø, H: 9.3 cm	6	5.30	4.77	4.24
140 63 23	23 cm Ø, H: 10.5 cm	6	6.90	6.21	5.52
140 63 29	29 cm Ø, H: 13.5 cm	6	11.90	10.71	9.52



Glasschüssel Fleur

		Stück	1	12	30
140 83 13	12.5 cm Ø, H: 5 cm	6	2.40	2.16	1.92
140 83 18	18 cm Ø, H: 6.5 cm	6	5.10	4.59	4.08
140 83 23	23 cm Ø, H: 8.8 cm	6	5.60	5.04	4.48
140 83 27	27 cm Ø, H: 9.8 cm	6	6.10	5.49	4.88

Table Top

Glasteller und Schüsseln Lys

		Stück	1	12	30
				10 %	20 %
141 40 13	13.5 cm Ø, Teller flach	6	1.40	1.26	1.12
141 40 19	19 cm Ø, Teller flach	6	2.00	1.80	1.60
141 40 23	23.5 cm Ø, Teller flach	6	2.40	2.16	1.92
141 41 14	14.5 cm Ø, Teller tief	6	1.50	1.35	1.20
141 41 21	21 cm Ø, Teller tief	6	2.10	1.89	1.68
141 41 23	23 cm Ø, Teller tief	6	2.30	2.07	1.84
141 42 10	10.5 cm Ø, H: 5 cm, Schüssel	6	1.40	1.26	1.12
141 42 13	13.5 cm Ø, H: 6.5 cm, Schüssel	6	2.30	2.07	1.84
141 43 13	13.5 cm Ø, H: 6.25 cm Schüssel mit Henkel	6	2.40	2.16	1.92



Glasteller Spiral

		Stück	1	12	30
				10 %	20 %
140 21 24	Teller tief, 24 cm Ø	6	6.90	6.21	5.52
140 20 30	Teller flach, 30 cm Ø	6	8.10	7.29	6.48
140 21 20	Teller tief, 20 cm Ø	6	6.00	5.40	4.80



Glasteller Piano

		Stück	1	12	30
				12.25	9.80
141 06 31*	31 cm Ø	6	1		



Glasteller Circle

		Stück	1	12	30
				10 %	20 %
141 30 24	24 cm Ø, Teller flach	6	3.00	2.70	2.40
141 30 27	27 cm Ø, Teller flach	6	4.40	3.96	3.52
141 30 30	30 cm Ø, Teller flach	6	5.00	4.50	4.00
141 31 26	26 cm Ø, Teller tief	6	5.90	5.31	4.72
141 36 13	H: 5.5 cm, 13 cm Ø, Schüssel	6	2.30	2.07	1.84
141 36 17	H: 5.5 cm, 17 cm Ø, Schüssel	6	2.70	2.43	2.16



Glasteller Rodin

		Stück	1	12	30
				10 %	20 %
140 36 21	Teller flach, 20.5 cm Ø	6	2.50	2.25	2.00
140 36 24	Teller flach, 24 cm Ø	6	2.80	2.52	2.24
140 36 27	Teller flach, 27 cm Ø	6	4.10	3.69	3.28
140 36 32	Teller flach, 31.5 cm Ø	6	5.60	5.04	4.48
140 37 20	Teller tief, 20 cm Ø	6	2.40	2.16	1.92
140 35 13	Schüssel, 12.5 cm Ø, H: 5 cm	6	1.60	1.44	1.28



Glasteller Cool

		Stück	1	12	30
				17.90	12.53
142 01 27	27 cm Ø, rund	6	1		
142 01 33	33 cm Ø, rund	4	1	49.90	13.93
142 01 26*	26 x 26 cm, quadratisch	6	1	48.90	13.23
142 01 30	30 x 30 cm, quadratisch	4	1	49.90	13.93



pieno *Star*



Glasteller Quadro

		Stück	1	30 %
141 00 26	26 x 26 cm, Klarglas	6	1	11.48
141 00 30	30.4 x 30.4 cm, Klarglas	6	1	14.70

pieno *Star*



Glasschale Exclusiva

		Stück	1	30 %
141 01 35	35 x 12.4 cm, Klarglas	5	1	8.26

pieno *Star*



Glasteller Retangolo

		Stück	1	30 %
141 04 30	30 x 12 cm	4	1	5.53

ab
6.51



Glasschale Retangolo Trio

		Stück	1	30 %
141 00 12	30.4 x 12 cm	4	1	6.51

pieno *Star*



Glasteller Blatt

		Stück	1	30 %
141 01 40	40 x 18 cm	5	1	13.86



Ypsilon

		Stück	1	60	120
170 56 15	Apérobecher, 1.5 dl, H: 9.5 cm, 7.7 cm Ø	6	1	2.30	1.84
177 53 22	Sorbet, 2.25 dl, H: 19.7 cm, 8.4 cm Ø	6	1	8.10	6.48



Frappés

		Stück	1	60	120
177 51 31	Frappés, 3.1 dl, H: 18 cm, 8 cm Ø	6	1	6.80	5.44



Platte Neo - Steelite Porzellan

		Stück	1	60	120
137 02 74	(G), 35.5 x 15.3 cm	12	1	44.40	33.30

Table Top



Ypsilon

	Stück	1	36
177 41 37	2	1	5.60
3.75 dl, H: 9.5 cm, 12.8 cm Ø			4.48 20 %



Galaxy
stapelbar

	Stück	1	36
177 14 32	6	1	1.90
3.2 dl, H: 6.5 cm, 11 cm Ø			1.52 20 %



Sundae

	Stück	1	36
177 44 13	36	1	3.40
1.3 dl, H: 10 cm, 8.5 cm Ø			2.72 20 %

ab
4,51



Elise

	Stück	1	36
177 08 40	6	1	5.30
4 dl, H: 10.2 cm, 12.5 cm Ø			4.51 15 %



Fortuna

	Stück	1	36
177 06 32	6	1	7.10
3.2 dl, H: 18 cm, 12.5 cm Ø			5.68 20 %



Primavera

	Stück	1	36
177 40 22	6	1	5.40
2.2 dl, H: 13.5 cm, 13.7 cm Ø			4.32 20 %



Mini-Fondue für 1 Person

	Stück	1	36
241 64 12	1	1	39.90
Mini-Fondue-Set			35.91 10 %



Schokoladen-Fondue Punkte

	Stück	1	36
241 67 12*	1	1	27.50
H: 15 cm, 12 cm Ø			24.75 10 %



San Marino

	Stück	1	36
177 28 25	6	1	6.30
2.5 dl, H: 12.5 cm, 15.5 cm Ø			5.36 15 %



Cornetto

	Stück	1	36
177 33 27	2	1	5.00
2.7 dl, H: 16.6 cm, 10 cm Ø			4.00 20 %



Helsinki

	Stück	1	36
177 07 26	6	1	3.40
2.6 dl, H: 9.5 cm, 10.5 cm Ø			2.72 20 %



Jazz

	Stück	1	36
177 02 33	6	1	4.00
3.3 dl, H: 20 cm, 7 cm Ø			3.20 20 %



Bolero

	Stück	1	36
			20 %
177 54 21	6	1	3.00 2.40
2.1 dl, H: 9.2 cm, 10.3 cm Ø			



Palmier

	Stück	1	36
			20 %
177 25 21	6	1	4.80 3.84
2.1 dl, H: 10 cm, 12.2 cm Ø			
177 25 37	6	1	8.30 6.64
3.7 dl, H: 20 cm, 11.7 cm Ø			



Hawaii

	Stück	1	36
			20 %
177 42 44	6	1	5.50 4.40
4.4 dl, H: 22 cm, 8.5 cm Ø			

ab
4.-



Rock Bar

	Stück	1	36
			20 %
177 13 38	6	1	5.00 4.00
3.8 dl, H: 18 cm, 8.5 cm Ø			



Brilliant

	Stück	1	36
			20 %
177 56 38	6	1	7.80 6.24
3.8 dl, H: 18.3 cm, 6 cm Ø			



Jazzed

	Stück	1	36
			20 %
177 24 25	6	1	5.50 4.40
2.5 dl, H: 13.3 cm, 15.5 cm Ø			
177 24 41	6	1	8.10 6.48
4.1 dl, H: 19.5 cm, 12.8 cm Ø			



Mondial Martini

	Stück	1	60
			10 %
161 15 21	6	1	5.30 4.77
220 ml, H: 17 cm, 10.5 cm Ø			



Coppa CNS 18/10

	Stück	1	36
			20 %
177 16 10	6	1	10.90 8.72
1.9 dl, H: 9 cm, 10 cm Ø			



Bubble

	Stück	1	36
			20 %
177 23 13	6	1	3.60 2.88
1.3 dl, H: 9 cm, 12 cm Ø			

Table Top



Allegro

	Stück	1	36
177 09 55	6	1	4.90 4.17
5.5 dl, H: 16.3 cm, 11.5 cm Ø			



Périgord

	Stück	1	36
160 03 22	6	1	4.50 3.60
2.2 dl, H: 9.7 cm, 10.8 cm Ø			

ab
3.60



Dune

	Stück	1	36
177 39 27	6	1	7.30 6.57
2.7 dl, H: 12 cm			



Coupe Versailles

	Stück	1	60
160 04 34	6	1	5.20 4.68
340 ml, H: 14 cm, 8.5 cm Ø			



Circle

	Stück	1	36
177 30 32	4	1	6.30 5.04
32 cm			
177 30 24	6	1	5.30 4.24
24.5 cm			



Palme

	Stück	1	36
179 00 02	1	144	20.00 16.00
23 cm			



Schweiz

	Stück	1	12
179 04 00	1	1000	24.80 19.84
7 cm			



Japanschirmchen

	Stück	1	12
179 07 00	1	144	9.70 8.73
9.5 cm			

Becher Caravelle

161 59 15 159 ml, H: 7.9 cm, 6.5 cm Ø

	Stück	1	60	120
	6	1	1.00 0.90	2.00 1.80



ab
0.80

40%



Fine Line

Klare, schnörkellose, jedoch prägnante Linien, reduziertes Design und ausgewogene Balance. Fine Line ist ein moderner Klassiker, welcher dem gedeckten Tisch eine edle Note verleiht.

CNS 18/10, Qualität 4.7 mm, poliert. Design brunelli.

		Stück		1
				40 %
150 50 10	Tafelgabel	12	1	3.96
150 50 20	Tafelmesser Monobloc	12	1	4.08
150 50 30	Tafellöffel	12	1	3.96
150 50 40	Kaffeelöffel	12	1	2.40
150 50 41	Espressolöffel	12	1	1.98
150 50 11	Dessertgabel	12	1	3.48
150 50 23	Dessertmesser Monobloc	12	1	3.96
150 50 31	Dessertlöffel	12	1	3.48
150 50 24	Fischmesser	12	1	3.96

40%



Rossi

Rossi hebt sich mit seinem markanten, kantigen Design ab, ist stimmig in der Form und wirkt mit seiner schlanken Linie modern und trendig und zeitlos klassisch zugleich. Das ansprechende Besteck, das zudem gut in der Hand liegt und Ihre Gäste begeistern wird.

CNS 18/10, Qualität 3.8 mm, poliert, Design brunelli.

		Stück		1
				40 %
150 16 10	Tafelgabel	12	1	3.96
150 16 20	Tafelmesser Monobloc	12	1	4.50
150 16 30	Tafellöffel	12	1	3.96
150 16 40	Kaffeelöffel	12	1	2.34
150 16 41	Espressolöffel	12	1	1.98
150 16 11	Dessertgabel	12	1	3.78
150 16 23	Dessertmesser Monobloc	12	1	4.38
150 16 31	Dessertlöffel	12	1	3.78
150 16 24	Fischmesser	12	1	3.96

Table Top

Verdi

Schlichte Eleganz, harmonische Proportionen und ausgezeichnete Haptik. Verdi schmiegt sich förmlich in die Hand und passt sowohl in ein modernes wie auch in ein traditionelles Ambiente.

CNS 18/10, Qualität 3.4 mm, poliert.

		Stück		1
				40 %
150 15 10	Tafelgabel	12	1	6.60 3.96
150 15 20	Tafelmesser Monobloc	12	1	7.50 4.50
150 15 30	Tafellöffel	12	1	6.60 3.96
150 15 40	Kaffeelöffel	12	1	3.90 2.34
150 15 41	Espressolöffel	12	1	3.30 1.98
150 15 42	Macchiatoöffel	12	1	6.20 3.72
150 15 11	Dessertgabel	12	1	6.30 3.78
150 15 23	Dessertmesser Monobloc	12	1	7.30 4.38
150 15 31	Dessertlöffel	12	1	6.30 3.78
150 15 32	Gourmetlöffel	12	1	6.60 3.96
150 15 24	Fischmesser	12	1	6.60 3.96



Canto

Markant, extra stark und schnörkellos präsentiert sich die Besteckserie Canto. Die breite Form und das moderne, kantige Design entspricht dem heutigen Zeitgeist. Canto besticht durch seine Optik und liegt perfekt in der Hand.

CNS 18/10, Qualität 4 mm, poliert

		Stück		1
				40 %
150 25 10	Tafelgabel	12	1	6.60 3.96
150 25 20	Tafelmesser Monobloc	12	1	7.50 4.50
150 25 30	Tafellöffel	12	1	6.60 3.96
150 25 40	Kaffeelöffel	12	1	3.90 2.34
150 25 41	Espressolöffel	12	1	3.30 1.98
150 25 11	Dessertgabel	12	1	6.30 3.78
150 25 23	Dessertmesser Monobloc	12	1	7.30 4.38
150 25 31	Dessertlöffel	12	1	6.30 3.78



40%



Premium

Formschön und funktionell zugleich. Bei Premium sind die Griffe von Löffel und Gabel stark gebogen, sodass die Besteckteile gut gegriffen werden können. Ein modernes und funktionelles Besteck.

CNS 18/10, Qualität 4 mm, poliert. Design brunelli.

		Stück		1
150 00 10	Tafelgabel	12	1	6.95 4.17
150 40 21	Tafelmesser Hohlheft	12	1	15.00 9.00
150 00 30	Tafellöffel	12	1	6.95 4.17
150 00 40	Kaffeeöffel	12	1	3.80 2.28
150 00 41	Espressoöffel	12	1	3.50 2.10
150 00 11	Dessertgabel	12	1	6.50 3.90
150 40 22	Dessertmesser Monobloc	12	1	6.50 3.90
150 40 23	Dessertmesser Hohlheft	12	1	14.00 8.40
150 00 31	Dessertlöffel	12	1	6.50 3.90
150 00 24	Fischmesser	12	1	6.95 4.17

40%



Pilatus

Das mit einer Materialstärke von 5 mm stärkste Besteck von premio-swiss. Da weiss man was man hat. Ansprechendes, funktionelles Design und ein ausgezeichnetes Preis-/Leistungsverhältnis.

CNS 18/10, Qualität 5 mm, poliert. Design brunelli.

		Stück		1
150 10 10	Tafelgabel	12	1	6.60 3.96
150 20 21	Tafelmesser Hohlheft	12	1	13.20 7.92
150 10 20	Tafelmesser Monobloc	12	1	7.20 4.32
150 10 30	Tafellöffel	12	1	6.60 3.96
150 10 40	Kaffeeöffel	12	1	3.90 2.34
150 10 41	Espressoöffel	12	1	3.60 2.16
150 10 11	Dessertgabel	12	1	6.30 3.78
150 20 23	Dessertmesser Hohlheft	12	1	12.90 7.74
150 10 21	Dessertmesser Monobloc	12	1	6.60 3.96
150 10 31	Dessertlöffel	12	1	6.30 3.78
		Stück		1
150 20 25	Steakmesser Hohlheft	12	1	13.90 11.12

Table Top

Baguette

Der Klassiker schlechthin. Baguette, für Bistros und Brasserien in Paris Mitte 19. Jahrhundert entwickelt, ist dieses Besteck nicht mehr aus der Gastronomie weg zu denken. Die Hohlheftmesser besitzen den charakteristischen Kropf bei Übergang von Klinge zu Heft.

CNS 18/10, Qualität 3.2 mm, poliert.

		Stück		1
				40 %
150 20 10	Tafelgabel	12	1	5.50 3.30
150 20 20	Tafelmesser Monobloc	12	1	NEW 6.50 3.90
150 20 26	Tafelmesser Hohlheft	12	1	13.20 7.92
150 20 30	Tafelöffel	12	1	5.50 3.30
150 20 40	Kaffeelöffel	12	1	3.30 1.98
150 20 41	Espressolöffel	12	1	3.20 1.92
150 20 11	Dessertgabel	12	1	4.90 2.94
150 20 27	Dessertmesser Hohlheft	12	1	12.80 7.68
150 20 28	Dessertmesser Monobloc	12	1	NEW 6.30 3.78
150 20 31	Dessertöffel	12	1	4.90 2.94
150 20 29	Steakmesser Monobloc	12	1	NEW 7.90 4.74
150 20 13*	Fischgabel	12	1	6.20 3.72
150 20 24	Fischmesser	12	1	7.20 4.32
150 20 32*	Gourmetlöffel	12	1	10.90 6.54
		Stück		1
				20 %
150 20 25	Steakmesser Hohlheft	12	1	13.90 11.12



Performance Edelstahl 18/0

Schlank und grazil, Löffel und Gabel sind gebogen für eine leichte Fassbarkeit. Performance liegt angenehm weich in der Hand dank ausbalanciertem Design. Die schlanke Form ist konsequent gestaltet bis zur Messerklinge. Diese Linie brilliert auch im Preis-Leistungs-Verhältnis.

Edelstahl 18/0, Qualität 3.5 mm, poliert. Design brunelli.

		Stück		1
				40 %
150 18 10	Tafelgabel	12	1	3.30 1.98
150 18 20	Tafelmesser Monobloc	12	1	4.60 2.76
150 18 30	Tafelöffel	12	1	3.30 1.98
150 18 40	Kaffeelöffel	12	1	2.00 1.20
150 18 41	Espressolöffel	12	1	1.60 0.96
150 18 11	Dessertgabel	12	1	2.90 1.74
150 18 22	Dessertmesser Monobloc	12	1	4.10 2.46
150 18 31	Dessertöffel	12	1	2.90 1.74
150 18 12	Kuchengabel	12	1	2.00 1.20





premiere **Star**

Nordic

Zeitlos, praktisch und sachlich, mit satiniertem Griff. Nordic ist ein Besteck für den täglichen Gebrauch zu einem unschlagbaren Preis-/Leistungsverhältnis.

CNS 18/10, Qualität 2.5 mm, Griff satiniert. Design brunelli.

		Stück		1
150 30 10	Tafelgabel	12	1	3.30 1.98 40 %
150 30 20	Tafelmesser Monobloc	12	1	5.00 3.00
150 30 30	Tafellöffel	12	1	3.50 2.10
150 30 40	Kaffeelöffel	12	1	2.20 1.32
150 30 41	Espressolöffel	12	1	2.10 1.26
150 30 11	Dessertgabel	12	1	3.20 1.92
150 30 31	Dessertlöffel	12	1	3.20 1.92



Besteck Sternegg Europa

CNS 18/10, poliert

		Stück		1
158 70 10	Tafelgabel	12	1	4.80 2.88 20 %
158 70 21	Tafelmesser Hohlheft	12	1	9.90 5.94
158 70 30	Tafellöffel	12	1	4.80 2.88
158 70 40	Kaffeelöffel	12	1	3.00 1.80
158 70 41	Espressolöffel	12	1	2.80 1.68
158 70 11	Dessertgabel	12	1	4.50 2.70
158 70 22	Dessertmesser Monobloc	12	1	4.50 2.70
158 70 23	Dessertmesser Hohlheft	12	1	9.60 5.76
158 70 31	Dessertlöffel	12	1	4.50 2.70



Besteck Econom

Das preisgünstige Gastrobesteck
Chromstahl, 2.2 mm, poliert

		Stück		1
151 80 10	Tafelgabel	12	1	1.90 1.52 20 %
151 80 20	Tafelmesser Monobloc	12	1	3.60 2.88
151 80 30	Tafellöffel	12	1	1.90 1.52
151 80 40	Kaffeelöffel	12	1	1.20 0.96



Reinhold Weiler

Trattoria

CNS 18/10

		Stück		1
152 55 10	Tafelgabel	12	1	7.20 5.76 20 %
152 55 20	Tafelmesser Monobloc	12	1	5.40 4.32
152 55 30	Tafellöffel	12	1	7.70 6.16
152 55 40	Kaffeelöffel	12	1	5.80 4.64
152 55 11	Dessertgabel	12	1	6.20 4.96
152 55 22	Dessertmesser Monobloc	12	1	5.00 4.00
152 55 31	Dessertlöffel	12	1	6.20 4.96
152 55 25	Steakmesser Wellenschliff	12	1	5.40 4.32

Table Top

Michelangelo Vintage

Es ist neu, sieht aber aus als ob es schon Jahrzehnte auf dem Buckel hätte. Das Vintage Besteck Michelangelo. In Zeiten der Rückbesinnung auf Altes und Bewährtes sind sie voll im Trend - Klassische Formen im "used look", nicht nur im Bistro und der Brasserie richtig, sondern auch im neuen Trendlokal.

CNS 18/10, 3.0 mm, matt

		Stück		1
				25 %
153 46 10	Tafelgabel	12	1	7.70 5.78
153 46 20	Tafelmesser Monobloc	12	1	10.00 7.50
153 46 30	Tafellöffel	12	1	7.70 5.78
153 46 40	Kaffeelöffel	12	1	3.90 2.93
153 46 41	Espressolöffel	12	1	3.90 2.93
153 46 11	Dessertgabel	12	1	7.60 5.70
153 46 22	Dessertmesser Monobloc	12	1	9.90 7.43
153 46 31	Dessertlöffel	12	1	7.60 5.70
153 46 24	Fischmesser	12	1	10.00 7.50



Dolce Vita Vintage

Essen wie zu Grossmutter's Zeiten! Im angesagten Vintage-Look präsentiert sich Dolce Vita. Durch seine Oberflächenbehandlung sieht es aus als ob es schon seit Generationen im Einsatz wäre. Die klassische Form - voll im Trend. Das perfekte Besteck für angesagte Lokale!

CNS 18/10, 3.0 mm, matt.

		Stück		1
				25 %
153 48 10	Tafelgabel	12	1	14.30 10.73
153 48 20	Tafelmesser Monobloc	12	1	21.40 16.05
153 48 30	Tafellöffel	12	1	14.30 10.73
153 48 40	Kaffeelöffel	12	1	7.50 5.63
153 48 41	Espressolöffel	12	1	7.50 5.63
153 48 11	Dessertgabel	12	1	14.20 10.65
153 48 22	Dessertmesser Monobloc	12	1	21.40 16.05
153 48 31	Dessertlöffel	12	1	14.20 10.65
153 48 24	Fischmesser	12	1	14.50 10.88



Epoque

Ihr Tisch wird strahlen, wenn Sie mit Epoque aufdecken! Das Besteck ist Hochglanz poliert und die gehämmerten Griffe lassen das Licht sehr schön reflektieren. Elegantes Besteck in hochwertiger Ausführung lassen Ihre Gäste zweimal hinschauen.

CNS 18/10, 4 mm, poliert und gehämmert

		Stück		1
				20 %
153 51 10	Tafelgabel	12	1	15.50 12.40
153 51 20	Tafelmesser Monobloc	12	1	19.80 15.84
153 51 30	Tafellöffel	12	1	15.50 12.40
153 51 40	Kaffeelöffel	12	1	7.70 6.16
153 51 41	Espressolöffel	12	1	7.70 6.16
153 51 11	Dessertgabel	12	1	15.50 12.40
153 51 22	Dessertmesser Monobloc	12	1	19.80 15.84
153 51 31	Dessertlöffel	12	1	15.50 12.40
153 51 24	Fischmesser	12	1	16.60 13.28





In den hochmodernen Fertigungen für Hohlwaren und Bestecke werden für die proHeq-Marken hunderte von Artikeln hergestellt, veredelt und kundenindividuell gestaltet. Produkte, deren nachhaltiges Design und Funktionalität für Gastlichkeit bei Kunden weltweit sorgen.

In über 150 Jahren hat die Marke HEPP den besten Hotels die internationale Tafelkultur mitgestaltet.

HEPP ist ISO 9001 und ISO 14001 zertifiziert

Die Einführung eines zertifizierten Qualitätsmanagementsystems ist ein wichtiger Schritt, um die Marke HEPP für die Zukunft zu rüsten. Wir wollen unsere Unternehmensleistung durch die kontinuierliche Verbesserung unserer Prozesse weiterhin steigern und auch für die Zukunft sicherstellen, dass sich die Marke HEPP im Wettbewerbsumfeld behaupten kann und unsere Produkte jederzeit den Anforderungen unserer Kunden entsprechen.

		Carlton CNS 18/10, 3.2 mm, poliert				
		Stück	1	120	240	
				10 %	20 %	
	153 40 10	Tafelgabel	12	5.10	4.59	4.08
	153 40 20	Tafelmesser Monobloc	12	7.60	6.84	6.08
	153 40 21	Tafelmesser Hohlheft	12	15.90	14.31	12.72
	153 40 30	Tafellöffel	12	5.10	4.59	4.08
	153 40 40	Kaffeelöffel	12	2.60	2.34	2.08
	153 40 41	Espressolöffel	12	2.00	1.80	1.60
	153 40 11	Dessertgabel	12	4.10	3.69	3.28
	153 40 22	Dessertmesser Monobloc	12	7.10	6.39	5.68
	153 40 23	Dessertmesser Hohlheft	12	15.30	13.77	12.24
	153 40 31	Dessertlöffel	12	4.10	3.69	3.28
	153 40 24	Fischmesser	12	4.10	3.69	3.28
	153 40 32	Gourmetlöffel	12	6.60	5.94	5.28

		Profile CNS 18/10, 5 mm, poliert				
		Stück	1	120	240	
				10 %	20 %	
	153 50 10	Tafelgabel	12	7.20	6.48	5.76
	153 50 20	Tafelmesser Monobloc	12	7.10	6.39	5.68
	153 50 30	Tafellöffel	12	7.10	6.39	5.68
	153 50 40	Kaffeelöffel	12	2.90	2.61	2.32
	153 50 41	Espressolöffel	12	2.70	2.43	2.16
	153 50 11	Dessertgabel	12	5.50	4.95	4.40
	153 50 22	Dessertmesser Monobloc	12	6.10	5.49	4.88
	153 50 31	Dessertlöffel	12	6.10	5.49	4.88
153 50 24	Fischmesser	12	6.30	5.67	5.04	

Table Top

Smart

CNS 18/10, 2.2 mm, poliert

	Stück	1	120	240
			10 %	20 %
153 41 10 Menugabel	12	2.00	1.80	1.60
153 41 20 Menumesser Monobloc	12	2.70	2.43	2.16
153 41 30 Menulöffel	12	2.00	1.80	1.60
153 41 40 Kaffeelöffel	12	1.00	0.90	0.80
153 41 42 Siruplöffel	12	1.60	1.44	1.28
153 41 12 Kuchengabel	12	1.00	0.90	0.80



Ecco

CNS 18/10, 2.8 mm, poliert

	Stück	1	120	240
			10 %	20 %
153 42 10 Tafelgabel	12	4.30	3.87	3.44
153 42 20 Tafelmesser Monobloc	12	5.90	5.31	4.72
153 42 30 Tafellöffel	12	4.40	3.96	3.52
153 42 40 Kaffeelöffel	12	2.50	2.25	2.00
153 42 41 Espressolöffel	12	2.30	2.07	1.84
153 42 11 Dessertgabel	12	3.70	3.33	2.96
153 42 22 Dessertmesser Monobloc	12	5.40	4.86	4.32
153 42 31 Dessertlöffel	12	3.70	3.33	2.96



Trend

CNS 18/10, 3.2 mm, poliert

	Stück	1	120	240
			10 %	20 %
153 43 10 Tafelgabel	12	3.60	3.24	2.88
153 43 20 Tafelmesser Monobloc	12	4.30	3.87	3.44
153 43 30 Tafellöffel	12	3.60	3.24	2.88
153 43 40 Kaffeelöffel	12	1.80	1.62	1.44
153 43 41 Espressolöffel	12	1.70	1.53	1.36
153 43 11 Dessertgabel	12	3.00	2.70	2.40
153 43 22 Dessertmesser Monobloc	12	3.60	3.24	2.88
153 43 31 Dessertlöffel	12	2.80	2.52	2.24



Contour

CNS 18/10, 3 mm, poliert

	Stück	1	120	240
			10 %	20 %
153 20 10 Tafelgabel	12	6.90	6.21	5.52
153 20 20 Tafelmesser Monobloc	12	11.70	10.53	9.36
153 20 21 Tafelmesser Hohlheft	12	24.50	22.05	19.60
153 20 30 Tafellöffel	12	8.50	7.65	6.80
153 20 40 Kaffeelöffel	12	3.00	2.70	2.40
153 20 41 Espressolöffel	12	2.80	2.52	2.24
153 20 11 Dessertgabel	12	5.70	5.13	4.56
153 20 23 Dessertmesser Hohlheft	12	23.50	21.15	18.80
153 20 22 Dessertmesser Monobloc	12	10.50	9.45	8.40
153 20 31 Dessertlöffel	12	5.70	5.13	4.56



Kreuzband

CNS 18/10, 3.5 mm, poliert

	Stück	1	120	240
			10 %	20 %
153 39 10 Tafelgabel	12	8.90	8.01	7.12
153 39 11 Dessertgabel	12	6.50	5.85	5.20
153 39 20 Tafelmesser Monobloc	12	11.20	10.08	8.96
153 39 21 Tafelmesser Hohlheft	12	21.30	19.17	17.04
153 39 22 Dessertmesser Monobloc	12	10.30	9.27	8.24
153 39 23 Dessertmesser Hohlheft	12	19.90	17.91	15.92
153 39 30 Tafellöffel	12	8.90	8.01	7.12
153 39 40 Kaffeelöffel	12	4.10	3.69	3.28
153 39 41 Espressolöffel	12	5.00	4.50	4.00





Besteck Hotel

CNS 18/10, 2.2 mm, poliert

			Stück		1
					20 %
155 30 10	Tafelgabel	12	1	3.20	2.56
155 30 20	Tafelmesser Monobloc	12	1	6.20	4.96
155 30 30	Tafellöffel	12	1	3.20	2.56
155 30 40	Kaffeelöffel	12	1	1.90	1.52
155 30 41	Espressolöffel	12	1	1.90	1.52
155 30 11	Dessertgabel	12	1	3.20	2.56
155 30 22	Dessertmesser	12	1	6.20	4.96
155 30 31	Dessertlöffel	12	1	3.20	2.56



Besteck Pitagora

CNS 18/10, 3 mm, poliert

			Stück		1
					20 %
154 90 10	Tafelgabel	12	1	5.40	4.32
154 90 20	Tafelmesser Monobloc	12	1	8.70	6.96
154 90 21	Tafelmesser Hohlheft	12	1	14.90	11.92
154 90 11	Tafellöfel	12	1	5.40	4.32
154 90 13	Kaffeelöffel	12	1	3.00	2.40
154 90 14	Espressolöffel	12	1	2.90	2.32
154 90 42	Siruplöffel	12	1	4.40	3.52
154 90 15	Dessertgabel	12	1	5.40	4.32
154 90 22	Dessertmesser Monobloc	12	1	8.50	6.80
154 90 23	Dessertmesser Hohlheft	12	1	14.90	11.92
154 90 16	Dessertlöffel	12	1	5.40	4.32
154 90 18	Fischgabel	12	1	5.90	4.72
154 90 19	Fischmesser	12	1	5.90	4.72



Buttermesser Pitagora

CNS 18/10

			Stück		1
					20 %
154 90 29	Buttermesser Hohlheft	12	1	11.60	9.28



Besteck Millenium

CNS 18/10, 4 mm, poliert

			Stück		1
					20 %
155 90 10	Tafelgabel	12	1	5.40	4.32
155 90 20	Tafelmesser Monobloc	12	1	8.50	6.80
155 90 30	Tafellöffel	12	1	5.30	4.24
155 90 40	Kaffeelöffel	12	1	3.20	2.56
155 90 41	Espressolöffel	12	1	3.10	2.48
155 90 11	Dessertgabel	12	1	5.40	4.32
155 90 22	Dessertmesser Monobloc	12	1	8.50	6.80
155 90 31	Dessertlöffel	12	1	5.30	4.24
155 90 24	Fischmesser	12	1	5.20	4.16



Besteck Byron

CNS 18/10, 3 mm, poliert

			Stück		1
					20 %
154 80 10	Tafelgabel	12	1	5.40	4.32
154 80 20	Tafelmesser Monobloc	12	1	8.20	6.56
154 80 21	Tafelmesser Hohlheft	12	1	14.80	11.84
154 80 30	Tafellöffel	12	1	5.50	4.40
154 80 40	Kaffeelöffel	12	1	2.90	2.32
154 80 41	Espressolöffel	12	1	2.70	2.16
154 80 11	Dessertgabel	12	1	5.40	4.32
154 80 22	Dessertmesser Monobloc	12	1	8.10	6.48
154 80 31	Dessertlöffel	12	1	5.00	4.00
154 80 24	Fischmesser Monobloc	12	1	6.10	4.88
154 80 23	Dessertmesser Hohlheft	12	1	12.20	9.76

Table Top

Besteck Europa

CNS 18/10, 2.5 mm, poliert

		Stück		1
				20 %
151 00 10	Tafelgabel	12	1	2.20 1.76
151 00 20	Tafelmesser Monobloc	12	1	3.00 2.40
151 00 30	Tafellöffel	12	1	2.90 2.32
151 00 40	Kaffeelöffel	12	1	1.80 1.44
151 00 41	Espressolöffel	12	1	1.70 1.36
151 00 11	Dessertgabel	12	1	2.90 2.32
151 00 22	Dessertmesser	12	1	3.00 2.40
151 00 31	Dessertlöffel	12	1	2.90 2.32



Besteck Luzern

CNS 18/10, 2.2 mm

		Stück		1
				20 %
151 10 10	Tafelgabel	12	1	2.90 2.32
151 10 20	Tafelmesser Monobloc	12	1	3.50 2.80
151 10 30	Tafellöffel	12	1	2.90 2.32
151 10 40	Kaffeelöffel	12	1	1.90 1.52
151 10 41	Espressolöffel	12	1	1.90 1.52
151 10 42	Siruplöffel, 21 cm	12	1	3.50 2.80
151 10 11	Dessertgabel	12	1	2.90 2.32
151 10 22	Dessertmesser	12	1	3.50 2.80
151 10 31	Dessertlöffel	12	1	2.90 2.32



Besteck Opera

CNS 18/10, 3.8 mm, satiniert

		Stück		1
				20 %
151 20 10	Tafelgabel	12	1	5.90 4.72
151 20 21	Tafelmesser Hohlheft	12	1	7.50 6.00
151 20 30	Tafellöffel	12	1	5.90 4.72
151 20 40	Kaffeelöffel	12	1	3.20 2.56
151 20 41	Espressolöffel	12	1	3.20 2.56
151 20 42	Opera, Siruplöffel	12	1	6.30 5.04
151 20 11	Dessertgabel	12	1	5.90 4.72
151 20 23	Dessertmesser	12	1	7.50 6.00
151 20 31	Dessertlöffel	12	1	5.90 4.72
151 20 24	Fischmesser	12	1	6.90 5.52
151 20 50	Gemüseegabel	1	1	14.00 11.20
151 20 51	Gemüselöffel	1	1	14.00 11.20



Messerbänkchen

Metall, verchromt

		Stück		1
				20 %
150 45 00	H: 1.5 cm, 8 x 3 cm	1	6	39.00 31.20



Kaffee-/ Espressolöffel

Chromstahl 13%, poliert, besonders preiswert

		Stück		1
151 90 40	Kaffeelöffel Hit, 13 cm	24	1	0.39
151 90 41	Espressolöffel Hit, 11.7 cm	24	1	0.39
151 91 41	Kaffeelöffel Standard, 13.5 cm	12	1	0.59
151 91 40	Espressolöffel Standard, 11.7 cm	12	1	0.59





Coupé-/Macchiato-Löffel

		Stück		1
150 15 42	Verdi, CNS 18/10, 18.5 cm	12	1	6.20 3.72 40 %



Kuchengabeln

		Stück	1	120	240
153 41 12	Smart 18/10	12	1	1.00	0.90 0.80 20 %
158 60 12	Sir 18/10	12	1		3.80 2.28 40 %
155 30 12	Hotel 18/10	12	1		2.50 2.00 20 %



Besteck Metropolitan

CNS 18/10, 4 mm, poliert

		Stück		1
158 41 10	Tafelgabel	12	1	9.80 7.84 20 %
158 41 20	Tafelmesser Monobloc	12	1	12.00 9.60
158 41 30	Tafellöffel	12	1	9.80 7.84
158 41 40	Kaffeelöffel	12	1	6.00 4.80
158 41 41	Espressolöffel	12	1	5.60 4.48
158 41 11	Dessertgabel	12	1	9.40 7.52
158 41 21	Dessertmesser Monobloc	12	1	11.00 8.80
158 41 31	Dessertlöffel	12	1	9.40 7.52



Salat- und Buffetbesteck Baguette

CNS 18/10

		Stück		1
150 20 51	Gemüselöffel, 26 cm	1	1	12.50
150 20 50	Gemüsegabel, 26 cm	1	1	12.50



Vorlege Besteck Pitagora

		Stück		1
154 90 51	Gemüselöffel, 23.3 cm	1	1	9.50 7.60 20 %
154 90 52	Gemüsegabel, 23.6 cm	1	1	9.50 7.60
154 90 50	Suppenschöpfer, 26.5 cm, 1 dl	1	1	20.90 16.72



Schöpfbesteck Robert Welch

CNS 18/10. Kann dank dem Hacken aufgehängt werden und verhindert das Abgleiten in die Schüssel, somit bleibt das Buffet und das Schöpfbesteck immer sauber

		Stück		1
402 02 06	Schöpfkelle klein, 26 cm	1	1	25.20 20.16 20 %
402 02 03	Reis-Servierlöffel, 26 cm	1	1	25.20 20.16
402 02 05	Schöpfkelle gross, 32 cm	1	1	25.20 20.16
402 02 01	Serviergabel, 33 cm	1	1	25.20 20.16
402 02 09	Servierlöffel gelocht, 32 cm	1	1	25.20 20.16
402 02 04	Bratschaufel gelocht, 34 cm	1	1	25.20 20.16
402 02 10	Spaghetti-Löffel, 32 cm	1	1	25.20 20.16
402 02 08	Chafing-Löffel lang, 32 cm	1	1	25.20 20.16
402 02 02	Servierlöffel kurz, 26 cm	1	1	25.20 20.16
402 02 07	Spachtel kurz, 30 cm	1	1	25.20 20.16
402 02 00	Schaumlöffel, 34 cm	1	1	25.20 20.16

Table Top



Steakmesser Churrasco

Steaks essen wie die Gauchos in Südamerika! Original Steakmesser aus Brasilien, wo man weiss wie man Fleisch geniesst! Klinge aus Hochleistungsstahl, hoher Korrosionsschutz. Angenehme Griffform gefertigt aus mehrschichtigem Polywood (patentierter Kombination aus Holz und Kunststoff), entwickelt für den anspruchsvollen Einsatz in gewerblichen Bereichen.

Spülmaschinenfest

Steakmesser Churrasco

		Stück		1
				30 %
152 16 48	Jumbo, 25 cm, bordeaux	12	1	8.50 5.95
152 16 85	Jumbo, 25 cm, braun	12	1	8.50 5.95



Steakmesser Churrasco

		Stück		1
				30 %
152 17 48	Gaucht, 23.6 cm, bordeaux	12	1	8.00 5.60
152 17 85	Gaucht, 23.6 cm, braun	12	1	8.00 5.60



Steakmesser Churrasco

		Stück		1
				30 %
152 20 48	21.8 cm, bordeaux	12	1	7.80 5.46
152 20 95	21.8 cm, braun	12	1	7.80 5.46



Steakmesser Churrasco glatte Klinge

		Stück		1
				30 %
152 19 48	French Style, 22.7 cm, bordeaux	12	1	24.50 17.15
152 19 85	French Style, 22.7 cm, braun	12	1	24.50 17.15



Steakgabel Churrasco

		Stück		1
				30 %
152 21 48	21 cm, bordeaux	12	1	9.80 6.86
152 21 85	21 cm, braun	12	1	9.80 6.86





Pizza-/Steakmesser Laguiole

Griff schwarz, genietet
Wellenschliff

	Stück		1
152 09 00	6	1	6.00 4.80 20 %



Pizza-/Steakmesser Laguiole

Griff elfenbein, genietet
Wellenschliff

	Stück		1
152 09 02	6	1	6.00 4.80 20 %



Pizza-/Steakmesser Laguiole

Griff sand, genietet
Wellenschliff

	Stück		1
152 09 82	6	1	6.00 4.80 20 %



Pizza-/Steakmesser Laguiole

Griff inox, genietet
Wellenschliff

	Stück		1
152 09 90	6	1	7.00 5.60 20 %



Pizza-/Steakmesser Laguiole

Griff grau, genietet
Wellenschliff

	Stück		1
152 09 95	6	1	6.00 4.80 20 %



Pizza-/Steakmesser HIT

Griff schwarz, aus ABS
Mikrowellenschliff

	Stück		1
152 00 00	12	1	2.30 1.84 20 %



Pizza-/Steakmesser Lux

Griff schwarz, aus ABS
Mikrowellenschliff

	Stück		1
152 01 00*	12	1	5.20 4.16 20 %



Pizza-/Steakmesser Paris

Griff schwarz, aus Bakelit
Mikrowellenschliff

	Stück		1
152 03 01	6	1	2.50 2.00 20 %



Pizza-/Steakmesser Victorinox

Griff schwarz, aus Polypropylen
Wellenschliff

	Stück		1
152 07 00	6	1	5.40 4.86 10 %



Pizza-/Steakmesser Elegance

Griff aus Chromstahl
Wellenschliff

	Stück		1
152 02 00	12	1	4.20 3.78 10 %



Pizza-/Steakmesser Steakhouse

Griff schwarz, genietet
Wellenschliff

	Stück		1
152 08 00*	12	1	5.30 3.18 40 %



Steakmesser Trattoria R. Welch

Griff schwarz genietet
Wellenschliff

	Stück		1
152 55 25	12	$\frac{1}{1=}$	7.20 4.32 20 %



Pizza-/Steakmesser Baguette

Hohlheft
CNS 18/10

	Stück		1
150 20 25	12	1	13.90 11.12 20 %

Table Top

Premio Apéro-Löffel

Dieser speziell für die Präsentation an Buffets entwickelte Apérolöffel unterscheidet sich von den herkömmlichen Produkten auf dem Markt. Durch den abgerundeten Essteil lassen sich die Häppchen sehr gut einnehmen. Es ist der erste Apérolöffel mit einer mundgerechten Form. Design brunelli



		Stück	1	48	96
132 07 14	14 x 4.5 cm	24	1	2.50	1.50

China-Löffel

		Stück	1	20 %	2.64
132 05 14	13.8 x 5 cm	12	1	3.30	2.64



Happy Hour

		Stück	1	48	96
151 98 03	10.6 cm, Gabel Happy Hour	12	1	4.50	4.05
151 98 01	12.5 cm, Partylöffel, schwere Qualität	12	1	6.20	5.58



Besteck Tapas Gaböffel

CNS 18/10

		Stück	1	20 %	1.52
151 98 15	Gaböffel, 11.7 cm	12	1	1.90	1.52



Besteck Tapas

		Stück	1	20 %	0.96
151 98 10	11.7 cm, Picklöffel	12	1	1.20	0.96
151 98 11	12 cm, Mini-Gabel	12	1	1.50	1.20
151 90 41	11.7 cm, Espressolöffel Hit	24	1		0.39



Bambus-Picker / Spiesse Satay

		Stück	1	5	10
330 26 09	Bambus-Picker Schlaufe, 9 cm	1	2000	79.00	39.50
330 26 10	Bambus-Picker Schlaufe, 9 cm	1	100		4.90
330 27 12	Spiess Satay, 12 cm	1	2000	69.00	34.50
330 27 13	Spiess Satay, 12 cm	1	100		3.90



Party-Clips "Welcome"

Für Apéros und Stehpartys. Der Party-Clip hält rutschsicher an jedem Tellerrand

		Stück	1	5	10
280 16 00	Kunststoff, weiss	1	100	99.00	89.10



Werbedruck auf Anfrage möglich

Tritan international patent

Das brillante, spülmaschinen- und bruchfeste Glas der Profis.



Kristallglas Ivento

		Stück	1	60	120	
161 67 35	No 0, Weinkelch, 350 ml, 207 mm, 77 mm Ø	6	1	3.60	3.24	2.70
161 67 51	No 1, Weinkelch, 510 ml, H: 222 mm, 76 mm Ø	6	1	3.60	3.24	2.70
161 67 01	No 1, Weinkelch, Eichung: 1 dl 510 ml, H: 222 mm, 85 mm Ø	6	1	4.40	3.96	3.30
161 67 63	No 130, Weinkelch, 630 ml, H: 235 mm, 76 mm Ø	6	1	3.60	3.24	2.70
161 67 78	No 140, Burgunder, 783 ml, H: 221 mm, 111 mm Ø	6	1	3.60	3.24	2.70
161 67 23	No 7, Champagner, 230 ml, H: 222 mm, 72 mm Ø	6	1	3.60	3.24	2.70



Kristallglas Congresso

		Stück	1	60	120	
161 60 32	No 2, Weinkelch, 317 ml, H: 182 mm, 74 mm Ø	6	1	3.80	3.42	2.85
161 60 36	No 0, Weinkelch, 355 ml, H: 195 mm, 77 mm Ø	6	1	3.80	3.42	2.85
161 60 46	No 1, Weinkelch, 455 ml, H: 205 mm, 83 mm Ø	6	1	3.80	3.42	2.85
161 60 63	No 130, Weinkelch, 621 ml, H: 222 mm, 93 mm Ø	6	1	3.80	3.42	2.85
161 60 24	No 7, Champagner, 235 ml, H: 207 mm, 66 mm Ø	6	1	3.80	3.42	2.85



Table Top

Kristallglas Vinā

		Stück	1	60	120
161 00 27	No 2, Weinkelch, 279 ml, H: 203 mm, 73 mm Ø	6	1	5.80	4.93
161 00 40	No 0, Weinkelch, 404 ml, H: 217 mm, 82 mm Ø	6	1	6.10	5.19
161 01 01	No 0, Weinkelch, Eichung: 1 dl, 404 ml, H: 217 mm, 82 mm Ø	6	1	6.90	5.87
161 00 51	No 1, Weinkelch, 513 ml, H: 227 mm, 88 mm Ø	6	1	6.10	5.19
161 02 01	No 1, Weinkelch, Eichung: 1 dl, 513 ml, H: 227 mm, 88 mm Ø	6	1	6.90	5.87
161 00 62	No 130, Weinkelch, 626 ml, H: 225 mm, 93 mm Ø	6	1	6.10	5.19
161 00 73	No 140, Burgunder, 732 ml, H: 221 mm, 111 mm Ø	6	1	6.10	5.19
161 00 21	No 7, Champagner, 227 ml, H: 225 mm, 70 mm Ø	6	1	6.10	5.19
161 00 01	No 7, Champagner, Eichung: 1 dl, 70 mm Ø, H: 225 mm, 227 ml	6	1	6.60	5.61



Kristallglas Classico

		Stück	1	60	120
161 25 21	No 2, Weinkelch, 312 ml, H: 210 mm, 75 mm Ø	6	1	4.80	4.32
161 25 40	No 0, Weinkelch, 408 ml, H: 225 mm, 82 mm Ø	6	1	5.20	4.68
161 25 54	No 1, Weinkelch, 545 ml, H: 240 mm, 90 mm Ø	6	1	5.20	4.68
161 25 64	No 130, Weinkelch, 645 ml, H: 250 mm, 95 mm Ø	6	1	5.20	4.68
161 26 21*	No 7, Champagner, 210 ml, H: 242 mm, 70 mm Ø	6	1	5.20	4.68

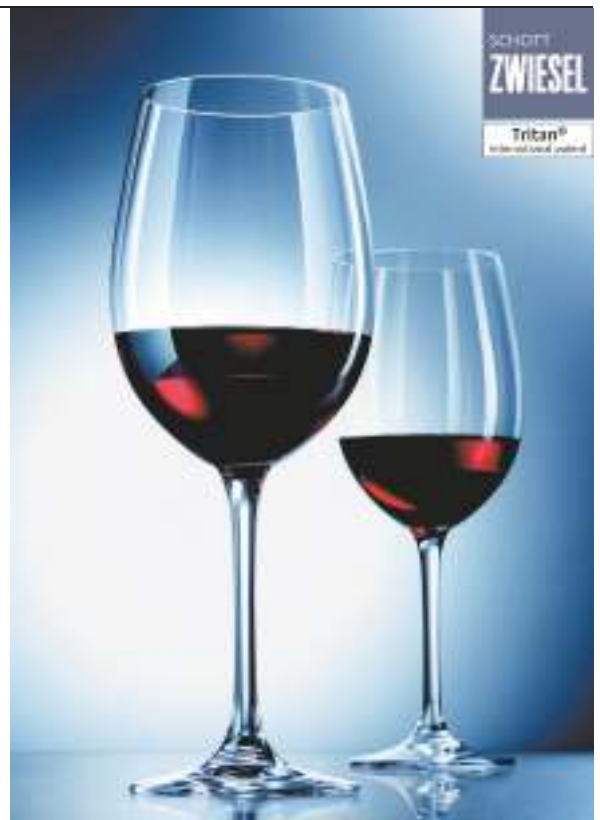
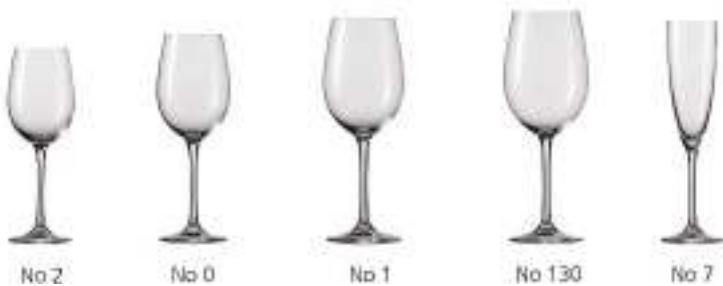



Kristallglas Fine

		Stück	1	60	120	
				10 %	25 %	
161 65 29	No 2, Weinkelch, 291 ml, H: 207 mm, 75 mm Ø	6	1	5.90	5.31	4.43
161 65 37	No 0, Weinkelch, 370 ml, H: 217 mm, 81 mm Ø	6	1	5.90	5.31	4.43
161 65 49	No 1, Weinkelch, 486 ml, H: 228 mm, 88 mm Ø	6	1	5.90	5.31	4.43
161 65 66	No 130, Weinkelch, 660 ml, H: 243 mm, 97 mm Ø	6	1	5.90	5.31	4.43
161 65 65	No 140, Burgunder, 657 ml, H: 221 mm, 106 mm Ø	6	1	5.90	5.31	4.43
161 65 24	No 7, Champagner, 235 ml, H: 228 mm, 72 mm Ø	6	1	5.90	5.31	4.43
161 65 30	No 77, Champagner, 295 ml, H: 236 mm, 72 mm Ø	6	1	5.90	5.31	4.43

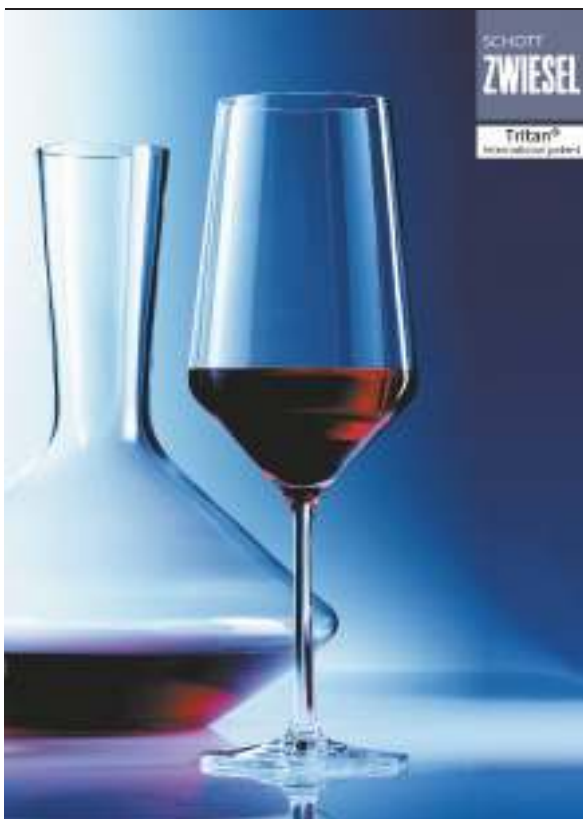

Kristallglas Pure

		Stück	1	60	120	
				10 %	25 %	
161 40 30	No 2, Weinkelch, 300 ml, H: 220 mm, 76 mm Ø	6	1	6.90	6.21	5.18
161 40 40	No 0, Weinkelch, 408 ml, H: 232 mm, 84 mm Ø	6	1	7.30	6.57	5.48
161 40 54	No 1, Weinkelch, 540 ml, H: 244 mm, 92 mm Ø	6	1	7.30	6.57	5.48
161 40 68	No 130, Weinkelch, 680 ml, H: 267 mm, 94 mm Ø	6	1	7.30	6.57	5.48
161 40 69*	No 140, Burgunder, 692 ml, H: 234 mm, 114 mm Ø	6	1	7.30	6.57	5.48
161 40 45*	No 32, Wasser, 451 ml, H: 177 mm, 84 mm Ø	6	1	7.30	6.57	5.48
161 40 36	No 42, 357 ml, H: 144 mm, 70 mm Ø	6	1	5.70	5.13	4.28
161 40 20	No 7, Champagner, 209 ml, H: 252 mm, 72 mm Ø	6	1	6.90	6.21	5.18
161 40 29	No 77, Champagner, 297 ml, H: 252 mm, 72 mm Ø	6	1	6.90	6.21	5.18

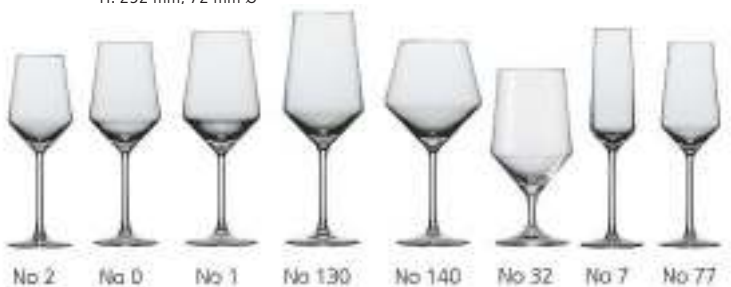

Table Top

Kristallglas Taste

		Stück	1	60	120	
				10 %	25 %	
161 51 36	No 0, Weinkelch, 356 ml, H: 211 mm, 79 mm Ø	6	1	4.20	3.78	3.15
161 51 50	No 1, Weinkelch, 497 ml, H: 225 mm, 87 mm Ø	6	1	4.20	3.78	3.15
161 51 66	No 130, Weinkelch, 656 ml, H: 237 mm, 96 mm Ø	6	1	4.20	3.78	3.15
161 51 79	No 140, Burgunder, 782 ml, H: 227 mm, 111 mm Ø	6	1	4.20	3.78	3.15
161 51 29	No 7, Champagner, 283 ml, H: 231 mm, 70 mm Ø	6	1	4.20	3.78	3.15



Kristallglas Fortissimo

		Stück	1	60	120	
				10 %	25 %	
161 45 40	No 0, Weinkelch, 404 ml, H: 249 mm, 62 mm Ø	6	1	5.60	5.04	4.20
161 45 50	No 1, Weinkelch, 505 ml, H: 258 mm, 88 mm Ø	6	1	5.60	5.04	4.20
161 45 63	No 130, Weinkelch, 633 ml, H: 271 mm, 93 mm Ø	6	1	5.60	5.04	4.20
161 45 72	No 140, Burgunder, 727 ml, H: 248 mm, 111 mm Ø	6	1	5.60	5.04	4.20
161 45 24	No 7, Champagner, 240 ml, H: 267 mm, 74 mm Ø	6	1	5.60	5.04	4.20

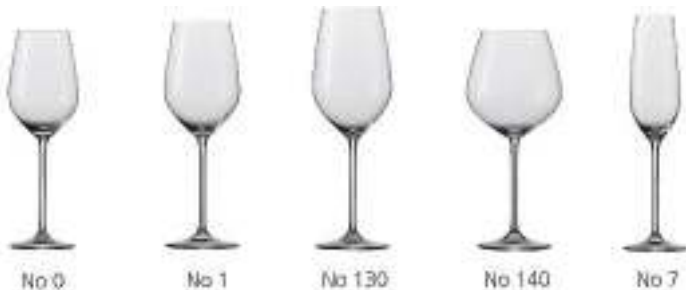



Kristallglas Diva

		Stück	1	60	120	
				10 %	25 %	
161 30 30	No 2, Weinkelch, 300 ml, H: 230 mm, 73 mm Ø	6	1	7.10	6.39	5.33
161 30 46	No 0, Weinkelch, 460 ml, H: 229 mm, 91 mm Ø	6	1	7.60	6.84	5.70
161 30 61	No 1, Weinkelch, 612 ml, H: 247 mm, 100 mm Ø	6	1	7.60	6.84	5.70
161 30 69	No 22, Weinkelch, 591 ml, H: 261 mm, 90 mm Ø	6	1	7.80	7.02	5.85
161 30 77	No 130, Weinkelch, 770 ml, H: 275 mm, 99 mm Ø	6	1	7.80	7.02	5.85
161 30 84	No 140, Burgunder, 840 ml, H: 248 mm, 116 mm Ø	6	1	7.80	7.02	5.85
161 30 22	No 7, Champagner, 220 ml, H: 253 mm, 72 mm Ø	6	1	7.80	7.02	5.85



Kristallgläser Air

		Stück	1	60	120	
				10 %	20 %	
161 62 31	No 2, Weinkelch, 306 ml, H: 191 mm, 77 mm Ø	6	1	7.40	6.66	5.92
161 62 42	No 0, Weinkelch, 420 ml, H: 200 mm, 88 mm Ø	6	1	7.40	6.66	5.92
161 62 63	No 1, Weinkelch, 625 ml, H: 219 mm, 99 mm Ø	6	1	7.40	6.66	5.92
161 62 83	No 130, Weinkelch, 827 ml, H: 232 mm, 108 mm Ø	6	1	7.40	6.66	5.92
161 62 78	Weinkelch, No 140, 660 ml, H: 213 mm, 116 mm Ø	6	1	7.40	6.66	5.92
161 62 33	No 77, Champagner, 322 ml, H: 233 mm, 73 mm Ø	6	1	7.40	6.66	5.92
161 62 32	No 8, Champagner, 312 ml, H: 147 mm, 105 mm Ø	6	1	7.40	6.66	5.92



Table Top

Kristallglas Sensa

		Stück	1	60	120	
				10 %	25 %	
161 83 36	No 2, Weinkelch, 363 ml, H: 222 mm, 76 mm Ø	6	1	6.90	6.21	5.18
161 83 53	No 1, Weinkelch, 535 ml, H: 236 mm, 88 mm Ø	6	1	6.90	6.21	5.18
161 83 01	No 1, Weinkelch, Eichung: 1 dl, 535 ml, H: 236 mm, 88 mm Ø	6	1	7.70	6.93	5.78
161 83 66	No 130, Weinkelch, 660 ml, H: 2243 mm, 94 mm Ø	6	1	6.90	6.21	5.18
161 83 71	No 140, Weinkelch, 710 ml, H: 230 mm, 105 mm Ø	6	1	6.90	6.21	5.18
161 83 38	No 77, Champagner, 388 ml, H: 240 mm, 72 mm Ø	6	1	6.90	6.21	5.18
161 83 50	No 42, Becher, 500 ml, H: 120 mm, 84 mm Ø	6	1	6.90	6.21	5.18



Kristallgläser Vini

		Stück	1	60	120	
				10 %	20 %	
162 00 30	No 03, Weinkelch, 305 ml, H: 198.5 mm, 75 mm Ø	6	1	4.60	4.14	3.68
162 00 37	No 02, Weinkelch, 370 ml, H: 206 mm, 78 mm Ø	6	1	4.90	4.41	3.92
162 00 44	No 01, Weinkelch, 448 ml, H: 224 mm, 83 mm Ø	6	1	5.60	5.04	4.48
162 01 01	No 01, Weinkelch, Eichung: 1 dl, 448 ml, H: 224 mm, 83 mm Ø	6	1	6.80	6.12	5.44
162 00 72	No 60, Weinkelch, 770 ml, H: 216 mm, 109 mm Ø	6	1	6.90	6.21	5.52
162 00 65	No 35, Weinkelch, 650 ml, H: 225 mm, 95 mm Ø	6	1	5.90	5.31	4.72
162 00 17	No 07, Champagner, 170 ml, H: 224 mm, 65 mm Ø	6	1	4.60	4.14	3.68
162 00 21	No 29, Champagner, 240 ml, H: 217 mm, 65 mm Ø	6	1	4.90	4.41	3.92

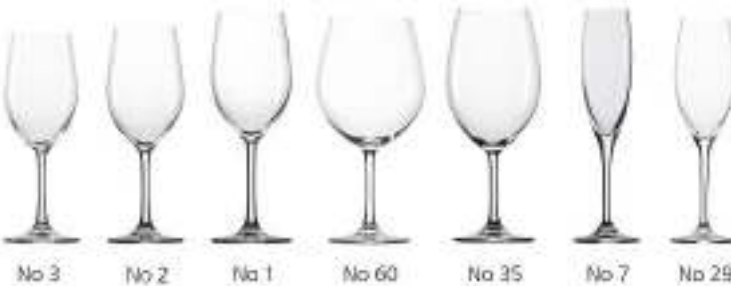



Riedel Kristallgläser

ab
2.20



No. 1

No. 0

No. 48

Kristallglas Degustazione Riedel

		Stück		1
160 70 34	No 1, Weinkelch, 340 ml, H: 205 mm, 79 mm Ø	12	1	2.75 2.20
160 70 35	No 1, Weinkelch, Eichung: 1 dl, 340 ml, H: 205 mm, 79 mm Ø	12	1	3.75 3.00
160 70 56	No 0, Weinkelch, 560 ml, H: 225 mm, 89 mm Ø	12	1	2.75 2.20
160 70 01	No 0, Weinkelch, Eichung: 1 dl, 560 ml, H: 225 mm, 89 mm Ø	12	1	3.75 3.00
160 70 21	No 48, Champagner, 212 ml, H: 224 mm, 78 mm Ø	12	1	2.75 2.20
160 71 01	No 48, Champagner, Eichung: 1 dl, 212 ml, H: 224 mm, 78 mm Ø	12	1	3.75 3.00

Kristallglas Restaurant Riedel



No. 5

No. 0

No. 2

No. 48

		Stück		1
160 72 35	No 5, Weinkelch, 350 ml, H: 203 mm, 79 mm Ø	12	1	5.00 4.00
160 72 61	No 0, Weinkelch, 610 ml, H: 215 mm, 95 mm Ø	12	1	5.00 4.00
160 72 36	No 2, Wasser, 350 ml, H: 148 mm, 78 mm Ø	12	1	5.00 4.00
160 72 26	No 48, Champagner, 260 ml, H: 217 mm, 70 mm Ø	12	1	5.00 4.00
160 73 01	No 48, Champagner, Eichung: 1 dl, 260 ml, H: 217 mm, 70 mm Ø	12	1	6.00 4.80

Kristallglas Restaurant Riedel



No. 15

No. 15

No. 30

No. 48

		Stück		1
160 72 37	No 15, Weinkelch, 370 ml, H: 215 mm, 79 mm Ø	12	1	5.00 4.00
160 72 01	No 15, Weinkelch, Eichung: 1 dl, 370 ml, H: 215 mm, 79 mm Ø	12	1	6.00 4.80
160 72 65	No 30, Weinkelch, 650 ml, H: 226 mm, 95 mm Ø	12	1	5.00 4.00
160 72 26	No 48, Champagner, 260 ml, H: 217 mm, 70 mm Ø	12	1	5.00 4.00
160 73 01	No 48, Champagner, Eichung: 1 dl, 260 ml, H: 217 mm, 70 mm Ø	12	1	6.00 4.80

Table Top

Kristallglas Restaurant Riedel

		Stück		1 20 %
160 72 71	No 97, Weinkelch, 700 ml, H: 195 mm, 108 mm Ø	12	1	5.00 4.00
160 72 70	No 7, Weinkelch, 700 ml, H: 215 mm, 108 mm Ø	12	1	5.00 4.00
160 72 26	No 48, Champagner, 260 ml, H: 217 mm, 70 mm Ø	12	1	5.00 4.00
160 73 01	No 48, Champagner, Eichung: 1 dl, 260 ml, H: 217 mm, 70 mm Ø	12	1	6.00 4.80



Kristallglas Swirl Riedel

		Stück		1 20 %
160 74 58	No 30, Weinkelch, 580 ml, H: 120 mm, 91 mm Ø	12	1	2.50 2.00



Kristallglas Restaurant O Riedel

		Stück		1 20 %
160 75 38	No 15, Becher, 375 ml, H: 108 mm, 79 mm Ø	12	1	3.75 3.00
160 75 60	No 0, Becher, 600 ml, H: 121 mm, 106 mm Ø	12	1	3.75 3.00



3.-

Kristallglas Cognac Bar Riedel

		Stück		1 20 %
160 76 02	No 71, Cognac, Eichung: 2 cl, 175 ml, H: 190 mm, 70 mm Ø	12	1	6.40 5.12
160 76 18	No 71, Cognac, 175 ml, H: 190 mm, 70 mm Ø	12	1	5.40 4.32



Kristallglas Champagner Overture Riedel

		Stück		1 20 %
160 77 29	No 8, Champagner, 290 ml, H: 224 mm, 70 mm Ø	12	1	3.75 3.00
160 77 01	No 8, Champagner, Eichung: 1 dl, 290 ml, H: 224 mm, 70 mm Ø	12	1	4.75 3.80



Kristallglas Manhattan Riedel

		Stück		1 20 %
160 73 30	No 1, Single Old Fashion, 290 ml, H: 90 mm, mm Ø	12	1	2.50 2.00
160 73 37	No 2, Double Old Fashion, 370 ml, H: 94 mm, mm Ø	12	1	2.50 2.00
160 73 29	No 3, Tumbler, 290 ml, H: 117 mm, mm Ø	12	1	2.50 2.00
160 73 35	No 4, Highball, 350 ml, H: 146 mm, mm Ø	12	1	2.50 2.00



2.-



Kristallglas Vino Grande

		Stück	1	60	120	
				10 %	20 %	
162 04 32	No 03, Weinkelch, 315 ml, H: 197 mm, 73 mm Ø	6	1	6.60	5.94	5.28
162 04 34	No 3b, Weinkelch, 340 ml, H: 211 mm, 78 mm Ø	6	1	7.10	6.39	5.68
162 04 43	No 04, Weinkelch, 424 ml, H: 224 mm, 84 mm Ø	6	1	7.10	6.39	5.68
162 04 62	No 4b, Weinkelch, 620 ml, H: 226 mm, 94 mm Ø	6	1	7.10	6.39	5.68
162 04 27	No 7b, Champagner, 258 ml, H: 230 mm, 64 mm Ø	6	1	7.10	6.39	5.68



Kristallglas Soirée

		Stück	1	60	120	
				10 %	20 %	
162 02 24	No 03, Weinkelch, 240 ml, H: 187 mm	6	1	4.70	4.23	3.76
162 02 29	No 02, Weinkelch, 290 ml, H: 194 mm	6	1	5.20	4.68	4.16
162 02 36	No 01, Weinkelch, 360 ml, H: 201 mm	6	1	5.20	4.68	4.16
162 02 51	No 35, Weinkelch, 510 ml, H: 221 mm	6	1	5.20	4.68	4.16
162 02 19	No 07, Champagner, 190 ml, H: 225 mm	6	1	5.10	4.59	4.08



Table Top

Kristallgläser exclusive by Gastroimpuls

Die Kristallgläser werden von einem bekannten europäischen Markenhersteller exklusiv für Gastroimpuls hergestellt. Sie erhalten Top-Qualität zu äusserst attraktiven Preisen!

Kristallglas Chiara

		☐ Stück		1 40 %
160 42 36	No 36, Weinkelch, 361 ml, H: 212 mm, 80 mm Ø	6	1	5.40 3.24
160 42 45	No 45, Weinkelch, 447 ml, H: 216 mm, 85 mm Ø	6	1	5.50 3.30
160 42 01	No 45, Weinkelch, Eichung: 1 dl, 447 ml, H: 216 mm, 85 mm Ø	6	1	6.10 3.66
160 42 58	No 58, Weinkelch, 580 ml, H: 226 mm, 92 mm Ø	6	1	5.60 3.36
160 42 18	No 18, Champagner, 181 ml, H: 219 mm, 51 mm Ø	6	1	5.10 3.06
160 43 01	No 18, Chiara, Champagner, Eichung: 1 dl, 181 ml, H: 219 mm, 51 mm Ø	6	1	5.60 3.36



Kristallglas Gioja

		☐ Stück		1 40 %
160 44 28	No 28, Weinkelch, 284 ml, H: 191 mm, 74 mm Ø	6	1	5.10 3.06
160 44 40	No 40, Weinkelch, 401 ml, H: 200 mm, 80 mm Ø	6	1	5.20 3.12
160 44 01	No 40, Weinkelch, Eichung: 1 dl, 401 ml, H: 200 mm, 80 mm Ø	6	1	5.50 3.30
160 44 55	No 55, Weinkelch, 545 ml, H: 216 mm, 89 mm Ø	6	1	5.30 3.18
160 42 18	No 18, Champagner, 181 ml, H: 219 mm, 51 mm Ø	6	1	5.10 3.06
160 43 01	No 18, Chiara, Champagner, Eichung: 1 dl, 181 ml, H: 219 mm, 51 mm Ø	6	1	5.60 3.36





Kristallglas Experience

"Betrachtet man das Verhältnis von Preis zu Punkten, liegt Stölzle vorn...". Dies das Fazit aus dem Blinddegustationstest der deutschen Zeitschrift Stern vom Dezember 2009. Als einziges maschinengefertigtes Kristallglas schafft es der Bordeauxkelch Experience von Stölzle auf den dritten Rang.

		Stück	1	60	120	
				10 %	20 %	
161 52 35	No 2, Weinkelch, 350 ml, H: 214 mm, 80 mm Ø	6	1	4.30	3.87	3.44
161 52 45	No 1, Weinkelch, 450 ml, H: 225 mm, 84 mm Ø	6	1	4.60	4.14	3.68
161 52 65	No 35, Weinkelch, 645 ml, H: 238 mm, 95 mm Ø	6	1	5.00	4.50	4.00
161 52 70	No 0, Burgunder, 695 ml, H: 231 mm, 105 mm Ø	6	1	5.00	4.50	4.00
161 52 19	No 7, Champagner, 188 ml, H: 224 mm, 63 mm Ø	6	1	4.30	3.87	3.44



Kristallglas Quatrophil

		Stück	1	60	120	
				10 %	20 %	
161 70 40	No 40, Weinkelch, 404 ml H: 245 mm, 83 mm Ø	6	1	5.50	4.95	4.40
161 70 57	No 57, Weinkelch, 568 ml, H: 250 mm, 96 mm Ø	6	1	6.00	5.40	4.80
161 70 64	No 64, Weinkelch, 644 ml, H: 255 mm, 102 mm Ø	6	1	6.00	5.40	4.80
161 70 70	No 70, Weinkelch, 708 ml, H: 245 mm, 116 mm Ø	6	1	6.00	5.40	4.80
161 70 29	No 29, Champagner, 292 ml, H: 255 mm, 102 mm Ø	6	1	5.50	4.95	4.40
161 70 07	Digestif Quatrophil, No 6, Eichung: 2 + 4 cl, 65 ml, H: 195 mm, 62.5 mm Ø	6	1	5.50	4.95	4.40



Table Top

Kristallgläser Melodia

		Stück	1	60	120	
				10 %	20 %	
161 81 15	Weinkelch, 160 ml, H: 167 mm, 74 mm Ø	6	1	5.40	4.86	4.32
161 81 21	Weinkelch, 210 ml, H: 190 mm, 81.5 mm Ø	6	1	5.70	5.13	4.56
161 81 27	Weinkelch, 270 ml, 200 mm, 86.6 mm Ø	6	1	5.90	5.31	4.72
161 81 31	Tumbler, 310 ml, H: 94 mm, 82 mm Ø	6	1	5.20	4.68	4.16
161 81 36	Longdrink, 360 ml, H: 150 mm, 70 mm Ø	6	1	5.30	4.77	4.24
161 81 16	Champagner, 160 ml, 222 mm Ø, 70 mm Ø	6	1	6.40	5.76	5.12



Kristallgläser Timeless

		Stück	1	60	120	
				10 %	20 %	
161 82 23	Weinkelch, 230 ml, H: 200 mm, 81 mm Ø	6	1	5.70	5.13	4.56
161 82 30	Weinkelch, 300 ml, H: 209 mm, 89 mm Ø	6	1	5.90	5.31	4.72
161 82 21	Champagner, 210 ml, H: 238 mm, 70 mm Ø	6	1	6.40	5.76	5.12
161 82 08	Shot/Amusebouche, 78 ml, H: 60 mm, 52 mm Ø	6	1	3.80	3.42	3.04
161 82 36	Tumbler, 360 ml, H: 92 mm, 86 mm Ø	6	1	5.20	4.68	4.16
161 82 44	Longdrink, 443 ml, H: 150 mm, 76 mm Ø	6	1	5.30	4.77	4.24



Kristallgläser Opera

		Stück	1	60	120	
				10 %	20 %	
160 29 30	Tumbler/Wasserglas, 300 ml, H: 94 mm, 82 mm Ø	12	1	4.60	4.14	3.68
160 29 35	Longdrink/Wasserglas, 350 ml, H: 150 mm, 70 mm Ø	12	1	4.60	4.14	3.68
161 13 24	Sekt/Dessert-Schale, 240 ml, H: 140 mm, 100 mm Ø	6	1	5.90	5.31	4.72



Saxon



		Stück	1	60	120	
				10 %	20 %	
160 35 20	Weinkelch, 200 ml, H: 142 mm, 65 mm Ø	12	1	1.60	1.44	1.28
160 35 01*	Weinkelch, Eichung: 1 dl, 200 ml, H: 142 mm, 65 mm Ø	12	1	1.80	1.62	1.44
160 35 25	Weinkelch, 250 ml H: 155 mm, 75 mm Ø	12	1	1.60	1.44	1.28
160 35 02*	Weinkelch, Eichung: 2 dl, 250 ml, H: 155 mm, 75 mm Ø	12	1	1.90	1.71	1.52
160 36 01	Champagner, Eichung: 1 dl, 160 ml, H: 158 mm, 55 mm Ø	12	1	1.70	1.53	1.36

Viticole



		Stück	1	60	120	
				10 %	20 %	
160 00 12	Weinkelch, 120 ml, H: 130 mm, 50 mm Ø	6	1	2.10	1.89	1.68
160 00 21	Weinkelch, 215 ml, H: 155 mm, 65 mm Ø	6	1	2.20	1.98	1.76
160 00 01	Weinkelch, Eichung: 1 dl, 215 ml, H: 155 mm, 65 mm Ø	6	1	2.40	2.16	1.92
160 00 31	Weinkelch, 310 ml, H: 175 mm, 70 mm Ø	6	1	2.80	2.52	2.24
160 01 01	Degustation, Eichung: 1 dl, 310 ml, H: 175 mm, 70 mm Ø	6	1	3.20	2.88	2.56



Kristallglas Mondial

		Stück	1	60	120	
				10 %	25 %	
161 15 20	No 3, Weinkelch, 200 ml, H: 180 mm, 72 mm Ø	6	1	3.90	3.51	2.93
161 15 25	No 2, Weinkelch, 250 ml, H: 187 mm, 75 mm Ø	6	1	3.90	3.51	2.93
161 15 01	No 2, Weinkelch, Eichung: 1 dl, 250 ml, H: 187 mm, 75 mm Ø	6	1	4.60	4.14	3.45
161 15 32	No 0, Weinkelch, 320 ml, H: 197 mm, 81 mm Ø	6	1	4.00	3.60	3.00
161 15 41	No 1, Weinkelch, 415 ml, H: 205 mm, 88 mm Ø	6	1	4.50	4.05	3.38
161 16 01	No 9, Mondial, Champagner, Eichung: 1 dl, 145 ml, H: 185 mm, 58 mm Ø	6	1	4.80	4.32	3.60
161 15 19	No 7, Champagner, 190 ml, H: 210 mm, 72 mm Ø	6	1	4.00	3.60	3.00
		Stück	1	30	60	
				10 %	20 %	
161 15 24	No 47, Cognac-Schwenker, Filet: 2 + 4 cl, 560 ml, H: 147 mm	6	1	5.60	5.04	4.48

Napoli



		Stück	1	60	120	
				10 %	20 %	
160 40 12	Weinkelch, 120 ml, H: 112 mm, 58 mm Ø	12	1	2.40	2.16	1.92
160 40 01	Weinkelch, Eichung: 1 dl, 120 ml, H: 112 mm, 58 mm Ø	12	1	2.60	2.34	2.08
160 40 18	Weinkelch, 180 ml, H: 125 mm, 66 mm Ø	12	1	2.40	2.16	1.92
160 40 24	Weinkelch, 240 ml, H: 140 mm, 70 mm Ø	12	1	2.40	2.16	1.92
160 40 02	Weinkelch, Eichung: 2 dl, 240 ml, H: 140 mm, 70 mm Ø	12	1	2.60	2.34	2.08
160 40 17	Champagner, 170 ml, H: 167 mm, 59 mm Ø	12	1	2.60	2.34	2.08
160 41 01	Miniflüte Napoli, Eichung: 1 dl, 150 ml, H: 157 mm, 56 mm Ø	12	1	3.00	2.70	2.40

Table Top

Gabriel Glas

Das erste universelle Weinglas.

Ob weiss, rot oder süss - alle Weine und Digestives bieten den maximalen Genuss.

		Stück	1	60	120
161 75 51	95 mm Ø, 510 ml, H: 230 mm	6	1	8.90	8.01
161 75 01	Eichung: 1 dl, 510 ml, H: 230 mm, 95 mm Ø	6	1	9.50	8.55
				5 %	10 %

Gläserkorb zu Gabriel Glas, 20 Unterteilungen

500 x 500 mm, Facheinteilung 99 x 99 mm

		Stück	1	
443 35 23	Gläserkorb grau	1	1	84.00



ab
8,01

Doc

Restistent, aus gehärtetem Glas

		Stück	1	60	120
160 10 12	Weinkelch, 120 ml, H: 136 mm, 54 mm Ø	6	1	2.90	2.03
160 10 21	Weinkelch, 215 ml, H: 155 mm, 65 mm Ø	6	1	2.90	2.03
160 10 01	Weinkelch, Eichung: 1+ dl, 215 ml, H: 155 mm, 65 mm Ø	6	1	3.40	2.38
160 10 31	Weinkelch, 310 ml, H: 174 mm, 70 mm Ø	6	1	4.00	2.80
160 11 01	Degustation, Eichung: 1 dl, 310 ml, H: 174 mm, 70 mm Ø	6	1	4.30	3.01
160 10 41	Weinkelch, 410 ml, H: 182 mm, 79 mm Ø	6	1	5.00	3.50
160 10 51	Weinkelch, 510 ml, H: 203 mm, 85 mm Ø	6	1	5.80	4.06

NEW



Vintage

Restistent, aus gehärtetem Glas

		Stück	1	60	120
160 20 25	Weinkelch, 250 ml, H: 180 mm, 65 mm Ø	6	1	4.00	2.80
160 20 01	Weinkelch, Eichung: 1 dl, 250 ml, H: 180 mm, 65 mm Ø	6	1	4.50	3.15
160 20 37	Weinkelch, 370 ml, H: 205 mm, 75 mm Ø	6	1	5.00	3.50
160 21 01	Degustation, Eichung: 1 dl, 370 ml, H: 205 mm, 75 mm Ø	6	1	5.60	3.92
160 20 41	Weinkelch, 415 ml, H: 225 mm, 75 mm Ø	6	1	5.60	3.92
160 22 01	Degustation, Eichung: 1 dl, 415 ml, H: 225 mm, 75 mm Ø	6	1	6.00	4.20



Michelangelo

		Stück	1	60	120
160 15 19	Weinkelch, 190 ml, H: 166 mm, 68 mm Ø	6	1	4.90	3.43
160 15 22	Weinkelch, 225 ml, H: 178 mm, 78 mm Ø	6	1	5.00	3.50
160 15 34	Weinkelch, 340 ml, H: 188 mm, 80 mm Ø	6	1	6.00	4.20
160 16 01	Champagner, 160 ml, H: 185 mm, 60 mm Ø, Eichung: 1 dl	6	1	5.30	3.71



premiere *Star*



Weinkaraffen Duo

Die neuen Karaffen mit Doppelreihung, statt zwei Karaffen jetzt nur noch eine! 50 % Platz- und bis 40 % Kosteneinsparung. Design brunelli

Aus Kristall-Glas, mundgeblasen

			Stück		1
170 13 12	Eichung: 1 + 2 dl, H: 150 mm, 70 mm Ø	6	1	23.00	16.10 30 %
170 13 35	Eichung: 3 + 5 dl, H: 206 mm, 95 mm Ø	6	1	30.00	21.00
170 13 10	Eichung: 1 l, H: 240 mm, 115 mm Ø	6	1	39.00	27.30



premiere *Star*



Karaffen Duo blue

Neu gibt es die Duo Karaffen auch mit einem im Boden eingearbeiteten blauen oder grünen Punkt. Dieser lässt das Wasser blau oder grün strahlen und verrät Ihnen sofort ob stilles Wasser oder prickelndes Wasser mit Kohlensäure serviert wurde. Eine grosse Erleichterung im Service. Design brunelli

Karaffe Duo blue für stilles Wasser

Aus Kristall-Glas, mundgeblasen

			Stück		1
171 60 05	Eichung: 5 dl, H: 206 mm, 95 mm Ø	6	1	30.00	21.00 30 %
171 60 10	Eichung: 1 l, H: 240 mm, 115 mm Ø	6	1	39.00	27.30

premiere *Star*



Karaffen Duo green

Karaffe Duo green für Wasser mit Kohlensäure. Design brunelli
Aus Kristall-Glas, mundgeblasen

			Stück		1
171 61 10	Eichung: 1 l, H: 240 mm, 115 mm Ø	6	1	39.00	27.30 30 %

Table Top

Dekanter

Kristallglas

	Stück				
170 21 00* Vintage, 1.4 l, H: 225 mm, 185 mm Ø	1	1	20.00	16.00	1 20 %



Dekanter Hit

Kristallglas

	Stück				
170 24 00 1.50 l, H: 230 mm, 240 mm Ø	1	1	30.00	18.00	1 40 %



Dekanter Audience

Perfekte Funktion, strahlender Glanz. Der Dekanter Audience überzeugt in Form und Funktion. Mit der speziellen Oberflächenveredelung DROP PROTECT wird die Tropfenbildung aussen am Glas verhindert. Tropfen für Tropfen wird im Gefäss gehalten - unerwünschte Flecken verhindert. Pflegeleicht und spülmaschinenfest.

	Stück				
170 27 00 0.75 l, H: 275 mm, 177 mm Ø	1	1	30.00	24.00	1 20 %



24.-

Karaffen-Halter

	Stück				
170 22 00 H: 320 mm, 215 mm Ø	1	1	31.30	21.91	1 30 %



Dekanter mit Durchgriff

Kristallglas

	Stück				
170 86 13* 0.7 l, H: 350 mm, 180 mm Ø	1	1	37.00	29.60	1 20 %



Dekanter mit Fingermulde

für optimalen Halt und leichtes einschenken, aus Kristallglas

	Stück				
170 88 07 1.3 l, H: 220 mm, 230 mm Ø	1	1	37.00	29.60	1 20 %





Dekanter First Class

		Stück	1	12	30
170 25 01	Eichung: 1 dl, 0.15 l, H: 125 mm, 85 mm Ø	6	1	14.80	13.32 10 % 11.84 20 %
170 25 02	Eichung: 2 dl, 0.29 l, H: 145 mm, 105 mm Ø	6	1	17.60	15.84 14.08
170 25 03	Eichung: 3 dl, 0.5 l, H: 165 mm, 120 mm Ø	6	1	20.60	18.54 16.48
170 25 05	Eichung: 5 dl, 0.7 l, H: 185 mm, 135 mm Ø	6	1	23.90	21.51 19.12



Weinkrug Alpnach

		Stück	1	12	30
170 03 01	Eichung: 1 dl, H: 110 mm, 60 mm Ø	6	1	15.20	13.68 10 % 12.16 20 %
170 03 02	Eichung: 2 dl, H: 137 mm, 77 mm Ø	6	1	17.30	15.57 13.84
170 03 03	Eichung: 3 dl, H: 153 mm, 85 mm Ø	6	1	18.50	16.65 14.80
170 03 05	Eichung: 5 dl, H: 180 mm, 104 mm Ø	6	1	22.00	19.80 17.60



Weinkrug Ideal

		Stück	1	12	30
170 04 01	Eichung: 1 dl, H: 96 mm, 65 mm Ø	6	1	16.10	14.49 10 % 12.88 20 %
170 04 02	Eichung: 2 dl, H: 110 mm, 85 mm Ø	6	1	17.10	15.39 13.68
170 04 03	Eichung: 3 dl, H: 128 mm, 85 mm Ø	6	1	18.50	16.65 14.80
170 04 05	Eichung: 5 dl, H: 150 mm, 105 mm Ø	6	1	21.00	18.90 16.80



Italienische Massflaschen

		Stück	1	12	30
170 05 25	2.5 dl, H: 190 mm, 68 mm Ø	12	1	3.00	2.70 10 % 2.40 20 %
170 05 05	5 dl, H: 235 mm, 84 mm Ø	12	1	4.10	3.69 3.28
170 05 10	1 l, H: 262 mm, 108 mm Ø	12	1	6.30	5.67 5.04



Wasserflaschen Purity, ungeeicht

		Stück	1	12	30
171 01 02	2.5 dl, H: 176 mm, 77 mm Ø	6	1	5.20	4.94 5 % 4.42 15 %
171 01 05	5 dl, H: 224 mm, 89 mm Ø	6	1	6.50	6.18 5.53
171 01 07	7.5 dl, H: 260 mm, 101 mm Ø	6	1	9.00	8.55 7.65



Budellen Ypsilon

		Stück	1	12	30
170 02 12	Eichung: 1 + 2 dl, H: 165 mm, 68 mm Ø	12	1	5.90	5.31 10 % 4.72 20 %
170 02 35	Eichung: 3 + 5 dl, H: 204 mm, 84 mm Ø	6	1	7.30	6.57 5.84
170 02 05	Eichung: 5 dl, H: 204 mm, 84 mm Ø	12	1	6.60	5.94 5.28
170 02 10	Eichung: 1 l, H: 255 mm, 104 mm Ø	6	1	10.80	9.72 8.64

ab
6.80



Karaffe Sublime

		Stück	1	30
171 59 10	ohne Eichung, H: 263 mm, 89 mm Ø	6	1	8.50 6.80 20 %
171 59 01	Eichung: 1 l, H: 263 mm, 89 mm Ø	6	1	9.50 7.60

Table Top

Karaffe Atelier

Aus SON.hyx, gehärtetes Kristall-Glas, sehr bruchfest, sehr gut waschbar

		Stück	1	12	30	
				10 %	20 %	
170 19 01	Eichung: 1 dl, H: 133 mm, 56 mm Ø	12	1	4.10	3.69	3.28
170 19 23	Eichung: 2 + 3 dl, H: 174 mm, 73 mm Ø	12	1	4.70	4.23	3.76
170 19 05	Eichung: 5 dl, H: 225 mm, 90 mm Ø	6	1	5.70	5.13	4.56
170 19 10	Eichung: 1 l, H: 280 mm, 108 mm Ø	6	1	8.70	7.83	6.96



Budellen Anny, mundrandverstärkt

		Stück	1	12	30	
				10 %	20 %	
171 12 01	Eichung: 1 dl, H: 155 mm, 46 mm Ø	6	1	15.60	14.04	12.48
171 12 02	Eichung: 2 dl, H: 185 mm, 60 mm Ø	6	1	7.10	6.39	5.68
171 12 03	Eichung: 3 dl, H: 210 mm, 65 mm Ø	6	1	8.60	7.74	6.88
171 12 05	Eichung: 5 dl, H: 240 mm, 80 mm Ø	6	1	14.70	13.23	11.76



Budellen Forté, mundrandverstärkt

		Stück	1	12	30	
				10 %	20 %	
170 01 01	Eichung: 1 dl, H: 159 mm, 45 mm Ø	6	1	14.60	13.14	11.68
170 01 02	Eichung: 2 dl, H: 193 mm, 59 mm Ø	6	1	17.50	15.75	14.00
170 01 03	Eichung: 3 dl, H: 234 mm, 62 mm Ø	6	1	20.40	18.36	16.32
170 01 05	Eichung: 5 dl, H: 272 mm, 78 mm Ø	6	1	23.90	21.51	19.12



Karaffe Pisa

		Stück	1	12	30	
				10 %	20 %	
170 17 01	Eichung: 1 dl, H: 130 mm, 77 mm Ø	12	1	4.80	4.32	3.84
170 17 02	Eichung: 2 dl, H: 163 mm, 93 mm Ø	12	1	5.40	4.86	4.32
170 17 03	Eichung: 3 dl, H: 172 mm, 97 mm Ø	12	1	5.60	5.04	4.48
170 17 05	Eichung: 5 dl, H: 206 mm, 118 mm Ø	6	1	7.00	6.30	5.60
170 17 10	Eichung: 1 l, H: 249 mm, 142 mm Ø	6	1	10.30	9.27	8.24



Flaschen Lory

mit Porzellanverschluss

		Stück	1	40	80	
				10 %	20 %	
171 51 05	0.5 dl, H: 115 mm, 42 mm Ø	20	1	2.40	2.16	1.92
171 51 10	1 dl, H: 145 mm, 45 mm Ø	16	1	2.50	2.25	2.00
171 51 02	2 dl, H: 188 mm, 56 mm Ø	12	1	2.40	2.16	1.92
171 51 04	3.5 dl, H: 260 mm, 65 mm Ø	15	1	2.80	2.52	2.24
171 51 06	5 dl, H: 280 mm, 70 mm Ø	12	1	3.10	2.79	2.48
171 52 10	1 l, H: 300 mm, 85 mm Ø	6	1	3.50	3.15	2.80



Flasche Sunny

mit Porzellanverschluss

		Stück	1	36	72	
				10 %	20 %	
171 51 07	7 dl, H: 250 mm, 90 mm Ø	6	1	6.20	5.58	4.96





Glaskrüge

		Stück	1	12	30	
170 08 13	Fleur, 1.3 l, H: 220 mm, 128 mm Ø	6	1	5.10	4.59	4.08
170 08 23	Tivoli, 2.3 l, H: 252 mm, 133 mm Ø	6	1	7.20	6.48	5.76



Glaskrüge Max

		Stück	1	12	30	
170 92 12	1.2 l, H: 210 mm, 120 mm Ø	6	1	6.40	5.76	5.12
170 92 15	1.5 l, H: 230 mm, 130 mm Ø	6	1	8.70	7.83	6.96



Glaskrüge

		Stück	1	12	30	
170 91 19	Acapulco, 1.9 l, H: 250 mm, 150 mm Ø	6	1	15.30	13.77	12.24
170 90 20	Ipanema, 2 l, H: 300 mm, 106 mm Ø	6	1	17.40	15.66	13.92



Krüge Kristallglas

		Stück	1	12	30	
170 13 10	Duo, mundgeblasen, H: 240 mm, Eichung: 1 l, 115 mm Ø	6	1	39.00	27.30	
170 07 15	Michelangelo, 1.5 l, H: 262 mm, 125 mm Ø	4	1	27.90	25.11	22.32



Polycarbonat Pitcher Classic

Aus transparentem Polycarbonat, spülmaschinenfest

		Stück	1	12	30	
171 19 15	Polycarbonat, 1.5 l, H: 265 mm, 210 mm Ø	1	1	18.00	16.20	14.40



Krug

		Stück	1	12	30	
170 12 00	Acryl, 165 mm Ø, H: 265 mm, 2 l	1	1	29.00	27.55	24.65

Table Top

Karaffe Sublime

		Stück			1
					20 %
171 59 10	ohne Eichung, H: 263 mm, 89 mm Ø	6	1	8.50	6.80
171 59 01	Eichung: 1 l, H: 263 mm, 89 mm Ø	6	1	9.50	7.60



6,80

Kühlkaraffe Cool

3-teilig
1 Glaskaraffe mit Edelstahl-Ausgießer, öffnet und schließt selbstständig, 1 verchromter Fuss inkl. 1 Kühlakku
Getränke werden bis zu 4 Stunden gekühlt

		Stück			1
					20 %
171 62 14	1.4 l, H: 270 mm, 160 mm Ø	1	1	57.00	45.60



Glasflasche Hydrosommelier

mit Porzellanverschluss

		Stück	1	36	72
				10 %	20 %
171 53 10	1 l, H: 338 mm, 85 mm Ø	6	1	7.90	7.11
					6.32



Borosilikat Karaffe Firenze

Deckel in Metall-Kunststoffkombination mit praktischer Ausgießfunktion für feinsten Trinkgenuss. Die Getränke werden durch die Verschlusstechnik geschützt und Zutaten, wie z.B. Eiswürfel, Zitronenscheiben oder Minze bleiben beim Ausgießen in der Karaffe.

		Stück	1	12	30
				10 %	20 %
170 90 11	1.1 l, H: 305 mm, 100 mm Ø	4	1	26.80	24.12
					21.44



Glaskaraffe Purus

mit Deckel aus Edelstahl

		Stück			1
					20 %
170 90 15	1.5 l, H: 270 mm, 95 mm Ø	1	1	35.00	28.00





Istanbul

			Stück	1	60	120
					10 %	20 %
170 50 02	Eichung: 2 dl, 250 ml, H: 106 mm, 63 mm Ø	12	1	1.40	1.26	1.12
170 50 03	Eichung: 3 dl, 350 ml, H: 145 mm, 67 mm Ø	12	1	1.60	1.44	1.28
170 50 05	Eichung: 5 dl, 600 ml, H: 173 mm, 77 mm Ø	12	1	2.00	1.80	1.60



Bowling

			Stück	1	60	120
					10 %	20 %
170 48 02	Eichung: 2 dl, 260 ml, H: 114 mm, 64 mm Ø	6	1	2.90	2.61	2.32
170 48 03	Eichung: 3 dl, 350 ml, H: 147 mm, 65 mm Ø	6	1	2.90	2.61	2.32

ab
1,60



Frankonia

Das Frankonia Longdrinkglas überzeugt durch seine schlichte Linienführung

			Stück	1	60	120
					10 %	20 %
170 95 28	280 ml, H: 142 mm, 64 mm Ø	6	1	2.00	1.80	1.60
170 95 39	390 ml, H: 160 mm, 73 mm Ø	6	1	2.60	2.34	2.08
170 95 66	660 ml, H: 190 mm, 86 mm Ø	6	1	3.00	2.70	2.40
170 95 02	Eichung: 2 dl, 280 ml, H: 142 mm, 64 mm Ø	6	1	2.20	1.98	1.76
170 95 03	Eichung: 3 dl, 390 ml, H: 160 mm, 73 mm Ø	6	1	2.70	2.43	2.16
170 95 05	Eichung: 5 dl, 660 ml, H: 190 mm, 86 mm Ø	6	1	3.50	3.15	2.80



New Vigne

			Stück	1	60	120
					10 %	20 %
170 47 22	220 ml, H: 111 mm, 61 mm Ø	6	1	1.90	1.71	1.52
170 47 33	330 ml, H: 126 mm, 69 mm Ø	6	1	1.90	1.71	1.52



Michelangelo

			Stück	1	60	120
					10 %	20 %
170 57 27	Whisky, 265 ml, H: 100 mm, 68 mm Ø	4	1	4.30	3.87	3.44
170 57 31	Longdrink, 310 ml, H: 143 mm, 59 mm Ø	4	1	4.60	4.14	3.68



Island

			Stück	1	60	120
					10 %	20 %
160 02 16	160 ml, 51 mm Ø, H: 100 mm	12	1	1.10	0.99	0.88
160 02 22	220 ml, 55 mm Ø, H: 129 mm	6	1	1.10	0.99	0.88
160 02 29	290 ml, 58 mm Ø, H: 144 mm	6	1	1.20	1.08	0.96
160 02 33	330 ml, 59 mm Ø, H: 156 mm	12	1	1.20	1.08	0.96
160 02 36	360 ml, 60 mm Ø, H: 170 mm	6	1	1.20	1.08	0.96



Ihr persönliches Glas

Sie möchten Ihr individuelles Glas selber gestalten?

Wir sind Ihnen gerne dabei behilflich

Table Top

Becher Impulso

Elegantes, klassisches Kristall-Wasserglas

		Stück	1	60	120
				10 %	20 %
161 39 47	465 ml, H: 120 mm, 85 mm Ø	6	1	3.70	2.96



Tritan-Kristallgläser Banquet

Elegantes, klassisches Wasserglas - Die perfekte harmonische Ergänzung

		Stück	1	60	120
				10 %	25 %
161 05 32	No 14, 320 ml, H: 120 mm, 68.5 mm Ø	6	1	3.80	2.85
161 05 42	No 42, 420 ml, H: 142 mm, 72 mm Ø	6	1	4.00	3.00
161 05 54	No 79, 540 ml, H: 156 mm, 77.5 mm Ø	6	1	4.40	3.30



Tritan-Kristallgläser Pure

Elegantes, modernes Wasserglas

		Stück	1	60	120
				10 %	25 %
161 40 36	No 42, 357 ml, H: 144 mm, 70 mm Ø	6	1	5.70	4.28
161 41 54	No 79, 555 ml, H: 165 mm, 80 mm Ø	6	1	6.20	4.65



Becher Sensa

		Stück	1	60	120
				10 %	25 %
161 83 50	No 42, 500 ml, H: 120 mm, 84 mm Ø	6	1	6.90	5.18



Becher Vino Grande

Elegantes, klassisches Wasserglas. Die perfekte harmonische Ergänzung zu allen Stielgläsern

		Stück	1	60	120
				10 %	20 %
161 06 38	No 12 Vino Grande, 410 ml, H: 156 mm, 68 mm Ø	6	1	4.80	3.84



Becher Soirée

		Stück	1	60	120
				10 %	20 %
171 36 03	No 37 Soirée, 218 ml, H: 105 mm, 63 mm Ø	6	1	3.60	2.88
171 36 02	No 13 Soirée, 340 ml, H: 144 mm, 64 mm Ø	6	1	4.10	3.28
171 36 01	No 27b Soirée, 413 ml, H: 158 mm, 68 mm Ø	6	1	4.30	3.44



Becher Top Class

Elegante und schlichte Becher aus gehärtetem Kristallglas

		Stück	1	60	120
				10 %	20 %
161 48 35	350 ml, H: 88 mm, 79 mm Ø	6	1	2.90	2.32
161 48 36	350 ml, H: 135 mm, 67 mm Ø	6	1	2.90	2.32
161 48 44	440 ml, H: 144 mm, 79 mm Ø	6	1	2.90	2.32



NEW



Becher Cube

		Stück	1	60	120	
				10 %	20 %	
170 56 24	Whiskeybecher, 2400 ml, H: 84 mm, 80 mm Ø	6	1	1.50	1.35	1.20
170 56 38	Longdrinkbecher, 375 ml, H: 140 mm, 77 mm Ø	6	1	1.70	1.53	1.36



Longdrinkbecher Salto

Eleganter Becher mit massivem Glasboden, geschmeidige Form, ideal für Wasser, Fruchtsäfte und Longdrinks

		Stück	1	60	120	
				10 %	20 %	
170 46 35	350 ml, H: 121 mm, 76 mm Ø	6	1	1.70	1.53	1.36
170 46 60	hellblau, 350 ml, H: 121 mm, 76 mm Ø	6	1	1.90	1.71	1.52



Stapelgläser Lyon

		Stück	1	60	120	
				10 %	20 %	
170 75 16	150 ml, H: 77 mm, 65 mm Ø	4	1	1.30	1.17	1.04
170 75 21	200 ml, H: 85 mm, 70 mm Ø	4	1	1.60	1.44	1.28



Stapelgläser Floro

		Stück	1	60	120	
				10 %	20 %	
170 96 16	160 ml, H: 70 mm, 67 mm Ø	6	1	2.20	1.76	1.76
170 96 01	Eichung: 1 dl, 160 ml, H: 70 mm, 67 mm Ø	6	1	2.60	2.08	2.08



Stapelgläser Tivoli

		Stück	1	48	96	
				10 %	20 %	
170 64 25	Tivoli, 250 ml, H: 76 mm, 78 mm Ø	24	1	1.00	0.90	0.80



Stapelgläser Amelia

		Stück	1	60	120	
				10 %	20 %	
170 62 16	Weisswein, 160 ml, H: 100 mm, 68 mm Ø	12	1	2.80	2.52	2.24
170 62 19	Rotwein, 190 ml, H: 105 mm, 72 mm Ø	12	1	2.80	2.52	2.24
170 62 25	Rotwein, 250 ml, H: 115 mm, 78 mm Ø	12	1	2.90	2.61	2.32



Longdrinkgläser/Apéro

		Stück	1	60	120	
				10 %	20 %	
170 51 04	Bowling, Filet: 4 cl, 350 ml, H: 147 mm, 66 mm Ø	6	1	3.80	3.42	3.04
170 52 04	Disco, Filet: 4 cl, 270 ml, H: 157 mm, 57 mm Ø	6	1	3.60	3.24	2.88
170 53 04	Disco, Filet: 4 cl, 340 ml, H: 140 mm, 68 mm Ø	6	1	3.70	3.33	2.96
170 54 04	Arosa, Filet: 4 cl, 170 ml, H: 120 mm, 65 mm Ø	6	1	2.60	2.34	2.08

Table Top

Luna Iceblue

		Stück	1	30	60
162 16 65	450 ml, H: 145 mm, 82 mm Ø	6	1	4.40	3.08



3.08

Wasserglas Bubbles

Jedes Glas ist ein Unikat, durchgefärbt, spülmaschinenfest

		Stück	1	30	60
160 16 00	transparent, 340 ml, H: 105 mm, 90 mm Ø	6	1	7.20	5.76
160 16 31	rosa, 340 ml, H: 105 mm, 90 mm Ø	6	1	7.20	5.76
160 16 45	rot, 340 ml, H: 105 mm, 90 mm Ø	6	1	7.20	5.76
160 16 51	grün, 340 ml, H: 105 mm, 90 mm Ø	6	1	7.20	5.76
160 16 65	blau, 340 ml, H: 105 mm, 90 mm Ø	6	1	7.20	5.76
160 16 95	topas, 340 ml, H: 105 mm, 90 mm Ø	6	1	7.20	5.76



ab
5.76

Wasserglas Toskana

farbig, mediterrane Gläser im Vintage-Style, durchgefärbt, spülmaschinenfest

		Stück	1	30	60
160 15 31	rosa, 265 ml, H: 100 mm, 80 mm Ø	6	1	7.00	5.60
160 15 35	lila, 265 ml, H: 100 mm, 80 mm Ø	6	1	7.00	5.60
160 15 55	grün, 265 ml, H: 100 mm, 80 mm Ø	6	1	7.00	5.60
160 15 84	bernstein, 265 ml, H: 100 mm, 80 mm Ø	6	1	7.00	5.60



Wasserglas Perle handgefertigt

Jedes Glas wird einzeln von Hand gefertigt und ist ein Unikat. Kleine Blasen sind das Ergebnis der Handwerkskunst. Diese Merkmale bestätigen die Qualität und Exklusivität jedes einzelnen Glases!

		Stück	1	12	24
160 14 45	rot, 320 ml, H: 110 mm, 75 mm Ø	6	1	20.00	16.00
160 14 55	grün, 320 ml, H: 110 mm, 75 mm Ø	6	1	20.00	16.00
160 14 60	aquamarin, 320 ml, H: 110 mm, 75 mm Ø	6	1	20.00	16.00
160 14 84	bernstein, 320 ml, H: 110 mm, 75 mm Ø	6	1	20.00	16.00
160 14 95	grau, 320 ml, H: 110 mm, 75 mm Ø	6	1	20.00	16.00



ab
6.40

Wasserglas Provenzale

Mit den farbigen Provenzale Gläsern im Vintage-Style zaubern Sie Abwechslung und Freude auf jeden Tisch.

		Stück	1	30	60
160 24 00	transparent, 270 ml, H: 105 mm, 75 mm Ø	6	1	8.00	6.40
160 24 51	grün, 270 ml, H: 105 mm, 75 mm Ø	6	1	8.00	6.40
160 24 65	blau, 270 ml, H: 105 mm, 75 mm Ø	6	1	8.00	6.40
160 24 95	taupe, 270 ml, H: 105 mm, 75 mm Ø	6	1	8.00	6.40



Bar

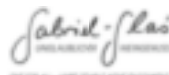



Bar

Bargläser / Digestif
Barartikel
Weinkultur



Rock Bar Lounge

Das ideale Glas für alle topaktuellen Drinks. Robust und perfekt stapelfähig, stossfest, hält Temperaturschock aus

			Stück	1	60	120
					10 %	20 %
170 82 23	peach, 270 ml, H: 92.5 mm, 84 mm Ø	6	1	2.90	2.61	2.32
170 82 54	mint, 270 ml, H: 92.5 mm, 84 mm Ø	6	1	2.60	2.34	2.08
170 82 60	ice blue, 270 ml, H: 92.5 mm, 84 mm Ø	6	1	2.50	2.25	2.00
170 83 23	peach, 370 ml, H: 120 mm, 83 mm Ø	6	1	3.60	3.24	2.88
170 83 54	mint, 370 ml, H: 120 mm, 83 mm Ø	6	1	3.60	3.24	2.88
170 83 60	ice blue, 370 ml, H: 120 mm, 83 mm Ø	6	1	3.60	3.24	2.88

ab
1,76



Rock Bar

Das ideale Glas für alle topaktuellen Drinks. Robust und perfekt stapelfähig, stossfest, hält Temperaturschock aus

			Stück	1	60	120
					10 %	20 %
170 42 02	Eichung: 2 dl, 270 ml, H: 89 mm, 82 mm Ø	6	1	2.20	1.98	1.76
170 42 37	370 ml, H: 120 mm, 83 mm Ø	6	1	2.70	2.43	2.16
170 42 03	Eichung: 3 dl, 370 ml, H: 120 mm, 83 mm Ø	6	1	2.50	2.25	2.00
170 42 36	Slim, 355 ml, H: 140 mm, 78 mm Ø	6	1	2.80	2.52	2.24

Granity

Speziell robust, mit Stapelring



			Stück	1	60	120
					10 %	20 %
170 45 00	45 ml, H: 58 mm, 48 mm Ø	12	1	1.10	0.99	0.88
170 45 16	160 ml, H: 75 mm, 68 mm Ø	12	1	1.30	1.17	1.04
170 45 27	270 ml, H: 98 mm, 85 mm Ø	12	1	1.50	1.35	1.20
170 45 02	Eichung: 2 dl, 270 ml, H: 98 mm, 85 mm Ø	12	1	1.90	1.71	1.52
170 45 36	350 ml, H: 120 mm, 83 mm Ø	12	1	1.90	1.71	1.52
170 45 03	Eichung: 3 dl, 350 ml, H: 120 mm, 83 mm Ø	12	1	2.30	2.07	1.84
170 45 31	310 ml, H: 140 mm, 73 mm Ø	12	1	1.90	1.71	1.52
170 45 25	Eichung: 2.5dl, 310 ml, H: 140 mm, 73mmØ	6	1	2.30	2.07	1.84
170 45 65	650 ml, H: 175 mm, 95 mm Ø	12	1	3.30	2.97	2.64
170 45 05	Eichung: 5 dl, 650 ml, H: 175 mm, 95 mm Ø	12	1	4.00	3.60	3.20

Gibraltar

gehärtetes Glas

		Stück	1	60	120	
				10 %	20 %	
170 43 30	295 ml, H: 120 mm, 79 mm Ø	6	1	2.10	1.89	1.68
170 43 35	355 ml, H: 124 mm, 84 mm Ø	6	1	2.10	1.89	1.68
170 43 36	355 ml, H: 144 mm, 79 mm Ø	6	1	2.10	1.89	1.68



Becher Casablanca

Mit Stapelring

		Stück	1	60	120	
				10 %	20 %	
170 40 27	270 ml, H: 91 mm, 86 mm Ø	12	1	1.10	0.99	0.88
170 40 02	Eichung: 2 dl, 270 ml, H: 91 mm, 86 mm Ø	12	1	1.40	1.26	1.12
170 40 36	355 ml, H: 123 mm, 83 mm Ø	12	1	1.40	1.26	1.12
170 40 03	Eichung: 3 dl, 355 ml, H: 123 mm, 83 mm Ø	12	1	1.60	1.44	1.28



Becher Turku

		Stück	1	60	120	
				10 %	20 %	
171 23 01	No 07, 70 ml, H: 66 mm, 55 mm Ø	6	1	1.90	1.71	1.52
171 23 02	No 27, 270 ml, H: 90 mm, 90 mm Ø	6	1	2.70	2.43	2.16
171 23 04	No 33, 330 ml, H: 100 mm, 93 mm Ø	6	1	2.80	2.52	2.24
171 23 03	No 32, 320 ml, H: 143 mm, 77 mm Ø	6	1	2.70	2.43	2.16
171 23 05	No 46, 450 ml, H: 170 mm, 82 mm Ø	6	1	2.80	2.52	2.24
171 23 06*	No 66, 660 ml, H: 191 mm, 92 mm Ø	6	1	3.20	2.88	2.56



Old Fashion

		Stück	1	60	120	
				10 %	20 %	
171 25 01	Old Fashion 25, 238 ml, H: 85 mm, 81 mm Ø	6	1	2.10	1.89	1.68
171 25 05	Old Fashion 25, Eichung: 2 dl, 238 ml, H: 85 mm, 81 mm Ø	6	1	2.00	1.80	1.60
171 25 03	Old Fashion 26, 360 ml, H: 100 mm, 92 mm Ø	6	1	2.70	2.43	2.16
171 25 06	Old Fashion 26, Eichung: 3 dl, 360 ml, H: 100 mm, 92 mm Ø	6	1	2.40	2.16	1.92
171 25 02	Old Fashion 27, 390 ml, H: 143 mm, 78 mm Ø	6	1	2.20	1.98	1.76
171 25 04	Old Fashion 27C, 580 ml, H: 160 mm, 88 mm Ø	6	1	3.20	2.88	2.56



Disco

		Stück	1	60	120	
				10 %	20 %	
171 13 01	50 ml, H: 67 mm, 45 mm Ø	6	1	2.20	1.98	1.76
171 13 03	270 ml, H: 159 mm, 57.5 mm Ø	6	1	2.40	2.16	1.92
171 13 04	260 ml, H: 93 mm, 76 mm Ø	6	1	2.60	2.34	2.08
171 13 15	150 ml, H: 70 mm, 69 mm Ø	6	1	2.00	1.80	1.60
171 13 06	340 ml, H: 140 mm, 68 mm Ø	6	1	3.40	3.06	2.72



Ypsilon

Das neue, schlichte und elegante Trendglas

		Stück	1	60	120	
				10 %	20 %	
170 56 15	Apérobecher, 1.5 dl, H: 9.5 cm, 7.7 cm Ø	6	1	2.30	2.07	1.84
170 56 04	Whiskybecher, Eichung: 4 cl, 255 ml, H: 107 mm, 92 mm Ø	3	1	2.50	2.25	2.00
170 56 32	Longdrink, Eichung: 2 + 4 cl, 320 ml, H: 160 mm, 77 mm Ø	6	1	3.90	3.51	3.12
170 56 16	Champagner, 160 ml, H: 235 mm, 64 mm Ø	3	1	5.20	4.68	4.16





Moscow Mule Kupfer Mug

CNS/Kupfer, gehämmert
Nicht spülmaschinenfest

		Stück	1	20 %	1
161 09 55	500 ml, H: 9.5 cm, 9 cm Ø	6	1	20.00	16.00



Moscow Mule Kupfer Mug

CNS/Kupfer. Servieren Sie den berühmten Moscow Mule sowie verschiedene Drinks in diesem klassischen Kupferbecher. Nicht spülmaschinenfest

		Stück	1	20 %	1
161 09 50	500 ml, H: 9 cm, 9 cm Ø	6	1	20.00	16.00



Drinking Jar Quattro Stagioni

Die trendigen Drinking Jar dürfen in keiner Bar fehlen und sorgen auch bei den Gästen für Gesprächsstoff.

		Stück	1	60	120
171 47 42	415 ml, H: 13.5 cm, 7.5 cm Ø	12	1	3.30	2.97
					2.64



Retro-Trinkhalme

Die rot/weiß gestreiften und biegsamen Papier-Trinkhalme im Look der 50er Jahre verleihen jedem Drink das gewisse Extra. Die Bio-Trinkhalme werden Ihre Gäste begeistern - sowohl durch ihren Stil als auch durch die Umweltfreundlichkeit.

		Stück	1	20 %	1
331 07 20	6 mm Ø, 19.5 cm	1	100	12.40	9.92

Lock-eat Drink Jar

		Stück	1	48	96
				10 %	20 %
178 33 03	2.5 dl, H: 15 cm, 7 cm Ø	12	1	3.20	2.88 2.56



Emaile Mugs Blue

		Stück	1	60	120
				10 %	20 %
132 86 10	100 ml, 7 cm Ø, H: 5 cm	12	1	6.20	5.58 4.96
132 86 36	360 ml, 9 cm Ø, H: 8 cm	12	1	7.00	6.30 5.60
132 86 57	568 ml, 10 cm Ø, H: 9 cm	12	1	8.60	7.74 6.88



Kelch Gin Tonic&Cocktail

		Stück	1	60	120
				10 %	20 %
161 34 65	660 ml, H: 19 cm, 11 cm Ø	6	1	3.30	2.97 2.64



ab
2.64

Kelch Spritz&Gin

So wird Gin & Tonic heute getrunken!
Ein absolutes Must im aktuellen Gin-Hype

		Stück	1	60	120
				10 %	20 %
161 38 66	660 ml, H: 16.8 cm, 11.5 cm Ø	6	1	3.90	3.51 3.12

Kristallgläser Opera

		Stück	1	60	120
				10 %	20 %
160 29 30	Tumbler/Wasserglas, 300 ml, H: 94 mm, 82 mm Ø	12	1	4.60	4.14 3.68
160 29 35	Longdrink/Wasserglas, 350 ml, H: 150 mm, 70 mm Ø	12	1	4.60	4.14 3.68
161 13 24	Sekt/Dessert-Schale, 240 ml, H: 140 mm, 100 mm Ø	6	1	5.90	5.31 4.72



Noblesse

Voll im Trend - im Look der 50er Jahre. Ästhetisch, mit edler Schliifoptik, aus feinstem Kristallglas

		Stück	1	60	120
				10 %	20 %
160 09 30	Whiskybecher, 295 ml, H: 100 mm, 82 mm Ø	12	1	5.90	5.31 4.72
160 09 38	Longdrink, 375 ml, H: 148 mm, 77 mm Ø	12	1	5.90	5.31 4.72



ab
2.00



Prosecco- und Champagnerglas Professional

		Stück	1	60	120
				10 %	20 %
160 37 01	Eichung: 1 dl, 140 ml, H: 178 mm, 61 mm Ø	12	1	2.50	2.25 2.00



Prosecco- und Champagnergläser 1 dl+

		Stück	1	60	120
				10 %	20 %
160 36 01	Flûte Saxon, Eichung: 1 dl, 160 ml, H: 158 mm, 55 mm Ø	12	1	1.70	1.53 1.36
160 31 01	Elégance, Eichung: 1 dl, 130 ml H: 180 mm, 48 mm Ø	12	1	2.60	2.34 2.08



Prosecco- und Champagnergläser

		Stück	1	60	120
				10 %	25 %
161 16 01	No 9, Mondial, Eichung: 1 dl, 145 ml, H: 185 mm, 58 mm Ø	6	1	4.80	4.32 3.60
				15 %	35 %
161 00 01	No 7, Vina, Eichung: 1+ dl, 227 ml, H: 225 mm, 70 mm Ø	6	1	6.60	5.61 4.29
				15 %	30 %
160 16 01	Michelangelo, Champagner, Eichung: 1 dl 160 ml, H: 185 mm, 60 mm Ø, ,	6	1	5.30	4.51 3.71
					40 %
160 43 01	No 18, Chiara, Eichung: 1 dl, 181 ml, H: 219 mm, 51 mm Ø	6	1	5.60	3.36



Proseccoglas Cylinder

		Stück	1	60	120
				5 %	10 %
160 19 01	Eichung: 1 dl, 200 ml, H: 191 mm, 48 mm Ø	24	1	3.80	3.61 3.42



Prosecco- und Champagnerglas Bubble

		Stück	1	60	120
				10 %	20 %
160 18 01	Eichung: 1 dl, 150 ml, H: 160 mm, 42 mm Ø	6	1	3.20	2.88 2.56
160 17 01	Eichung: 1 dl, 200 ml, H: 180 mm, 44 mm Ø	6	1	3.90	3.51 3.12



Likörglas Elegante

		Stück	1	60	120
				10 %	20 %
160 38 07	70 ml, H: 138 mm, 57 mm Ø	6	1	4.20	3.78 3.36

Kristallglas Champagner Ouverture Riedel

		Stück	1	60	120
					20 %
160 77 29	No 8, Champagner, 290 ml, H: 224 mm, 70 mm Ø	12	1	3.70	3.00
160 77 01	No 8, Champagner, Eichung: 1 dl, 290 ml, H: 224 mm, 70 mm Ø	12	1	4.70	3.80



Sekt-Schale Bar Special

		Stück	1	60	120
					25 %
161 12 28	281 ml, H: 152 mm, 106 mm Ø	6	1	6.80	5.10
161 12 01	Eichung: 1 dl, 281 ml, H: 152 mm, 106 mm Ø	6	1	7.40	5.55



Mondial Martini

		Stück	1	60	120
					25 %
161 15 21	220 ml, H: 17 cm, 10.5 cm Ø	6	1	5.30	3.98



Becher Fresh

		Stück	1	60	120
					20 %
170 32 15	Eichung: 2 + 4 cl, 270 ml, H: 175 mm, 52 mm Ø	6	1	4.10	3.28
170 32 20	270 ml, H: 175 mm, 52 mm Ø	6	1	2.90	2.32
170 32 25	330 ml, H: 172 mm, 57 mm Ø	6	1	3.30	2.64
170 32 30	400 ml, H: 200 mm, 59 mm Ø	6	1	3.60	2.88
170 32 50	570 ml, 69 mm Ø, H: 238 mm	6	1	5.10	4.08



Cocktailglas Hurricane

		Stück	1	36
				20 %
177 03 25	2.5 dl, H: 19.5 cm, 6.5 cm Ø	6	1	5.00
177 03 44	4.4 dl, H: 21 cm, 8 cm Ø	6	1	5.50



Marguerita Elite

		Stück	1	60	120
					20 %
177 00 27	270 ml, H: 145 mm, 116 mm Ø	6	1	4.60	3.68



NEW



Craft Bier

		Stück	1	60	120
161 85 30	300 ml, H: 171 mm, 85 mm Ø	6	1	5.30	4.77
				10 %	20 %
					4.24

Bier-/Wasserglas Fresh



		Stück	1	60	120
170 33 20	Eichung: 2 dl, 270 ml, H: 175 mm, 52 mm Ø	6	1	3.40	3.06
170 33 25	Eichung: 2.5 dl, 330 ml, H: 172 mm, 57 mm Ø	6	1	3.80	3.42
170 33 30	Eichung: 3 dl, 400 ml, H: 200 mm, 59 mm Ø	6	1	4.20	3.78
170 33 50	Eichung: 5 dl, 570 ml, H: 238 mm, 69 mm Ø	6	1	5.60	5.04
					4.48

Bierglas Classic



		Stück	1	60	120
170 39 02	Eichung: 2 dl, 270 ml, H: 178 mm, 61 mm Ø	6	1	2.95	2.66
170 39 03	Eichung: 3 dl, 380 ml, H: 218 mm, 65 mm Ø	6	1	3.60	3.24
					2.88

Classic Seidel



		Stück	1	60	120
170 94 02	Eichung: 2 dl, 270 ml, H: 158 mm, 94 mm Ø	6	1	3.20	2.88
170 94 03	Eichung: 3 dl, 370 ml, H: 180 mm, 102 mm Ø	6	1	4.00	3.60
170 94 05	Eichung: 5 dl, 610 ml, H: 211 mm, 117 mm Ø	6	1	5.20	4.68
					4.16

Biergläser



		Stück	1	60	120
170 37 02	Rolinck, Eichung: 2 dl, 2.75 dl, H: 164 mm, 66 mm Ø	6	1	4.10	3.69
170 37 25	Rolinck, Eichung: 2.5 dl, 3.35 dl, H: 170 mm, 72 mm Ø	12	1	4.50	4.05
170 29 02	Palladio, Eichung: 2 dl, 2.5 dl, H: 208 mm, 66 mm Ø	6	1	3.40	3.06
170 29 03	Palladio, Eichung: 3 dl, 3.85 dl, H: 238 mm, 72 mm Ø	6	1	3.80	3.42
					3.04

Grappaglas Digestivo

- 1/2 Portion auch für Autofahrer
- Einheitsglas für klare Brände
- Kristallglas mundgeblasen
- Design by brunelli

	Stück	1	60	120
170 28 14 Eichung: 1 + 2 + 4 cl, H: 215 mm, 60 mm Ø	6	1	11.70	9.95
			15 %	

Cognacglas Digestivo

- Einheitsglas für fassgereifte Brände
- Kristallglas mundgeblasen
- Design by brunelli

	Stück	1	60	120
170 28 24 Eichung: 2 + 4 cl, H: 215 mm, 80 mm Ø	6	1	11.70	9.95
			15 %	



Whiskygläser

	Stück	1	60	120
170 66 04 Disco, Filet: 4 cl, 260 ml, H: 95 mm, 75 mm Ø	6	1	3.60	2.88
170 58 04* Veronese Whisky, Eichung: 4 cl, 260 ml, H: 91 mm	6	1	4.90	3.92
			10 %	20 %



Cognac-/Sherrygläser

	Stück	1	30	60
160 00 24 Viticole, Filet: 2 + 4 cl, 120 ml, H: 130 mm, 55 mm Ø	6	1	3.10	2.48
160 10 24 DOC, Eichung: 2 + 4 cl, 215 ml, H: 155 mm, 60 mm Ø	6	1	3.70	2.96
161 30 24 Sherry-Glas Diva, Eichung: 2 + 4 cl, 110 ml, H: 190 mm, 60 mm Ø	6	1	7.00	5.60
161 15 24 No 47, Mondial Cognac-Schwenker, Eichung: 2 + 4 cl, 560 ml, H: 147 mm	6	1	5.60	4.48
162 10 24 Cognac Vino Grande, Eichung: 2 + 4 cl, 558 ml, H: 153 mm, 102 mm Ø	6	1	8.90	7.12
			10 %	20 %



Cognac-/Grappagläser

	Stück	1	30	60
170 67 02 Grappa Riserva, Eichung: 2 + cl, 80 ml, H: 165 mm, 55 mm Ø	6	1	4.40	3.52
162 11 24 Grappa Vino Grande, Eichung: 2 + 4 cl, 102 ml, H: 200 mm, 45 mm Ø	6	1	8.90	7.12
162 24 24 Digestif Vino Grande, Eichung: 2 + 4 cl, 235 ml, H: 181 mm, 68 mm Ø	6	1	8.90	7.12
161 70 07 No 6, Digestif Quatrophil, 65 ml, H: 195 mm, 62.5 mm Ø, Eichung: 2 + 4 cl	6	1	5.50	4.40
			10 %	20 %



Kirschgläser

	Stück	1	60	120
170 68 02 Filet: 2 cl, 32 ml, H: 70 mm, 45 mm Ø	6	1	1.60	1.28
170 68 24 Filet: 2 + 4 cl, 57 ml, H: 87 mm, 51 mm Ø	6	1	1.80	1.44
170 69 06 Islande, 65 ml, H: 105 mm, 35 mm Ø	12	1	0.80	0.64
170 69 24 Filet: 2 + 4 cl, 65 ml, H: 105 mm, 35 mm Ø, Islande	12	1	1.90	1.52
170 69 07 Islande satiniert, 65 ml, H: 105 mm, 35 mm Ø	12	1	2.20	1.76
			10 %	20 %





SPIEGELALU

Whiskyglas Snifter Premium

		Stück	1	60	120
171 37 24	280 ml, H: 192 mm, 71 mm Ø, Eichung: 2 + 4 cl	2	1	9.40	8.46
					10 % 20 %
					7.52 7.52



Whiskyglas Glencairn

		Stück	1	60	120
160 08 19	190 ml, H: 116 mm, 67 mm Ø	6	1	5.90	5.31
160 08 04	Eichung: 4 cl, 190 ml, H: 116 mm, 67 mm Ø	6	1	6.20	5.58
					10 % 20 %
					4.72 4.72
					4.96 4.96



Kristallglas Digestif Bar Riedel

		Stück	1
160 76 02	No 71, Digestif, Eichung: 2 cl, 175 ml, H: 190 mm, 70 mm Ø	12	1
160 76 18	No 71, Digestif, 175 ml, H: 190 mm, 70 mm Ø	12	1
			20 % 20 %
			4.32 4.32

8.50



Bitterflasche/Dash bottle

mit Ausgiesser

		Stück	1
310 67 00	Elixir N°1, 100 ml	1	1
310 67 01	Elixir N°2, 100 ml	1	1
310 67 02	Elixir N°3, 100 ml	1	1
			8.50 8.50
			8.50 8.50



Mixing Glas

		Stück	1
310 19 05	0.5 l, H: 16.5 cm, 9 cm Ø	1	1
			23.00 18.40

NEW



Boston-Shaker Kupfer Look

Edelstahlbecher, aussen verkupfert, nicht spülmaschinenfest

		Stück	1
310 49 00	Boston-Shaker, 0.7 l, inkl. Glas 0.4 l	1	1
			24.00 19.20

Cocktail-Shaker by Charles Schumann

CNS 18/10

		Stück	1
310 13 00	Cocktail-Shaker 0.7 l	1	1
			38.40 38.40

Charles Schumann

Bar

Boston-Shaker

CNS 18/10

Inkl. Mixing-Glas mit Gummiring, 5 Cocktailrezepte und Maßeinteilung bis 390 ml

	Stück			
	1	1	21.00	16.80
310 15 00				20 %



Bar Shaker

CNS 18/10

	Stück			
	1	1	24.00	19.20
310 14 00				20 %
	1	1		8.70
310 14 50				20 %
	1	1	29.00	23.20
310 16 00				20 %



Kisag iSi Soda Siphon

Sodawasser & Cocktails prickelnd einfach gemacht

Edelstahlflasche, 1.0 l, Kopf aus Nylon

	Stück			
	1	1		99.00
300 58 10				
	1	10		8.90
300 58 50				



Julep Barsieb

Edelstahl, hochglänzend

	Stück			
	1	1		13.00
310 34 18				



Cocktailsieb

	Stück			
	1	1		12.00
310 17 00*				



Cocktailsieb

CNS 18/10, schwere Qualität, hochglänzend

	Stück			
	1	1		12.50
310 17 09				



Cocktailsieb

Edelstahl, hochglänzend

	Stück			
	1	1		6.90
310 17 11				



Barlöffel

	Stück			
	1	1	9.60	7.68
310 18 00				
	12	1	6.30	5.04
151 20 42				
	12	1	3.50	2.80
151 10 42				





Kipmasse

Chromnickelstahl 18/10, schwere Qualität

		Stück		1
				10 %
310 20 20	2 cl	1	1	27.40 24.66
310 20 40	4 cl	1	1	28.40 25.56
310 20 24	2 / 4 cl, Doppel	1	1	8.20 7.38



Cocktail-Doppelmass 2/4 cl

Chromnickelstahl 18/10

		Stück		1
				10 %
310 20 24	2 / 4 cl, Doppel	1	1	8.20 7.38



Holzstößel / Limettenpresse

		Stück		1
				30 %
310 57 00	2 cm Ø, 15.5 cm	1	1	11.00 7.70
310 57 01	2.5 cm Ø, 21 cm	1	1	12.00 8.40



Barstößel/Muddler

ABS Kunststoff, 4 cm Ø

Grober Stößel, zum Auspressen von Früchten und Zerstossen von Würfelzucker

		Stück		1
				20 %
310 54 00	4 cm Ø, 24 cm	1	1	12.00 9.60



Zitronen- und Limettenpresse

Mit den 2 verschiedenen grossen Pressringen können Limetten und Zitronen mühelos ausgepresst werden. Aus Aluminium-Druckguss, spülmaschinen geeignet

		Stück		1
				20 %
310 21 21	21 cm, 7 cm Ø, H: 5 cm	1	1	22.00 17.60



Master Pour, mit Ausgiesser

Behälter mit Ausgiesser und Deckel, nur komplett erhältlich

		Stück		1
				10 %
310 29 15	1 l, gelb	1	1	7.10 6.39
310 29 25	1 l, orange	1	1	7.10 6.39
310 29 45	1 l, rot	1	1	7.10 6.39
310 29 55	1 l, grün	1	1	7.10 6.39
310 33 15	2 l, gelb	1	1	7.80 7.02
310 33 25	2 l, orange	1	1	7.80 7.02
310 33 45	2 l, rot	1	1	7.80 7.02
310 33 55	2 l, grün	1	1	7.80 7.02

NEW



Flaschen-/Barregal

Edelstahl, zur Wandmontage

		Stück		1
310 62 82	8 Flaschen, 82 x 10 cm, H: 15 cm	1	1	69.00
310 62 00	10 Flaschen, 107 x 10 cm, H: 15 cm	1	1	98.00

Bever Mat®

Mass-Ausgiesser - Der schnellste Repetier-Ausgiesser, präzise, solid, mit flexiblen Lamellen, Kunststoff schwarz, Klappdeckel als Schutz vor dem Verriechen

		Stück		1
				40 %
310 30 20	2 / 4 cl	1	1	27.50 16.50
310 30 30	3.0 / 6.0 cl	1	1	27.50 16.50
310 30 35*	3.5 / 7.0 cl	1	1	27.50 16.50



Flaschen-Ausgiesser

		Stück		1
				40 %
310 35 10	Auto-Pour, 1.0 cl	1	1	12.80 7.68
310 35 20	Auto-Pour, 2.0 cl	1	1	12.80 7.68
310 35 40	Auto-Pour, 4.0 cl	1	1	12.80 7.68



Permanent-Ausgiesser

Permanent-Ausgiesser mit extra langem Luftrohr, feinstrahlig

		Stück		1
				20 %
310 47 00	Permanent-Ausgiesser	6	1	3.90 3.12



Permanent-Ausgiesser

		Stück		1
				20 %
310 36 01	Jet-Pour permanent	12	1	2.70 2.16
310 39 00	Messing verchromt, Kunststoffzapfen	1	1	3.00 2.40
310 37 00	Permanent-Ausgiesser Silikonkork mit Klappe CNS 18/10	1	1	3.90 3.12



Getränkedosierer Galassi

Luftdichter Verschluss mit Plastik-Zapfen, Montage auf Table oder mit den hulu Wandhaltern überall möglich. Nicht geeignet für anishaltige Spirituosen

		Stück		1
310 40 20	Komplett, 2.0 cl	1	1	57.00
310 40 25	Komplett, 2.5 cl	1	1	57.00
310 40 30	Komplett, 3.0 cl	1	1	57.00
310 40 40	Komplett, 4.0 cl	1	1	57.00
				10 %
310 41 20	Dosierkopf, 2.0 cl	1	1	35.50 31.95
310 41 25	Dosierkopf, 2.5 cl	1	1	35.50 31.95
310 41 30	Dosierkopf, 3.0 cl	1	1	35.50 31.95
310 41 40	Dosierkopf, 4.0 cl	1	1	35.50 31.95
310 42 00	Ersatz-Zapfen aus Kunststoff	1	3	7.00 6.30





Beilagenbehälter Kunststoff

Mit 6 austauschbaren Behältern

		Stück		1
310 53 00	45 x 15 cm, H: 9 cm, 0.5 l	1	1	33.00 26.40
				20 %



Edelstahl-Beilagenbehälter

Mit 6 austauschbaren Kunststoff-Behältern

		Stück		1
310 60 00	45 x 15 cm, H: 9 cm, 0.45 l	1	1	62.00 49.60
				20 %



Beilagen-/Gewürz-Box

		Stück		1
310 52 00*	46.5 x 13 cm, H: 7.5 cm, 0.7 l	1	1	15.00 13.50
310 52 50*	Deckel, 47.5 x 14 cm	1	1	8.00 7.20
				10 %



Barrailmatte

Kunststoff, marmoriert (schwarz)

		Stück		1
310 55 45	46 x 30.5 cm	1	1	395.00 355.50
310 55 59	68 x 8 cm	1	1	29.00 26.10
				10 %



Zitruspresse

CNS 18/10

		Stück		1
310 56 00	H: 9 cm, 17 cm Ø	1	1	31.00 21.70
				30 %



Bar-Kombination

Je eine Schale für Zucker, Salz und Zitronensaft

		Stück		1
310 50 00		1	1	29.00 20.30
				30 %



Barschneidebrett

Für Buffets und Bars

		Stück		1
310 58 00	22 x 14 cm, H: 0.8 cm	1	1	16.80

Barmixer Hamilton Beach

Mit 1.2 l Polycarbonat-Becher, 2 Geschwindigkeitsstufen

		Stück		1	10 %
320 44 00	18 cm Ø, H: 36 cm, 230 V, 400 W, 4.1 kg	1	1	332.00	298.80



298.80

Bar Memory Blender 2 Rotor

Der programmierbare gewerbliche Hochleistungsmixer mit Edelstahlgehäuse:

- 12 speicherbare Zyklen für automatische Verarbeitung
- 6 fixe Drehzahlen im manuellen Modus
- Mit überwachter Schall- und Berührungsschutzhaube
- leise, kompakt, solid und elegant, einfach zu reinigen
- Swiss made

		Stück		1	10 %
430 08 00	Motorsockel RMB 2, Leistung 1000W,~1600W Spitze, 1000-17000 U/min., 26.5x22.5/41x22.5 cm offen, H: 50.5/61 cm offen, 230 V, 1000 W, 8 kg	1	1	1206.00	1206.00
430 10 54	Mixaufsatz Polycarbonat stapelbar, 2 l	1	1	153.00	153.00
430 12 51	Mixaufsatz CNS, 2 l	1	1	324.00	324.00

ROTOR



Bar Blender Rotor

Edelstahlgehäuse, 2 oder 3 Geschwindigkeitsstufen und Impulsschalter, leise. Swiss made.

		Stück		1	10 %
430 09 10*	Motorsockel RBB2, Leistung 400W,~700W Spitze, 8000/14000 U/min., 19 cm Ø, H: 48 cm, 230 V, 400 W, 4.6 kg	1	1	525.00	472.50
430 09 11	Motorsockel RBB3, Leistung 550W,~1000W Spitze, 4000-14000 U/min., 19 cm Ø, H: 48 cm, 230 V, 550 W, 4.6 kg	1	1	610.00	549.00
430 10 54	Mixaufsatz Polycarbonat stapelbar, 2 l	1	1	170.00	153.00
430 12 51	Mixaufsatz CNS, 2 l	1	1	360.00	324.00

ROTOR



Getränke-Mixer Rotor

Metallgehäuse verchromt, Dauerbetriebsmotor mit stufenloser, elektronischer Drehzahlregulierung, sehr leise. Swiss made.

Dauerleistung: 600 W / Spitzenleistung: 1100 W, Drehzahl 1000-17000 U/min.

		Stück		1	10 %
430 14 00	Motorsockel GT 600, 230 V, 600 W, 4 kg	1	1	670.00	603.00
430 10 54	Mixaufsatz Polycarbonat stapelbar, 2 l	1	1	170.00	153.00
430 12 51	Mixaufsatz CNS, 2.0 l	1	1	360.00	324.00

ROTOR



Getränke-Mixer Rotor Professional

Metallgehäuse, 9000 - 18'000 Touren/Min., stufenlos regulierbar, mit CNS-Becher 0.8 l, Swiss made

		Stück		1	5 %
320 25 00	silbergrau/blau, 17 x 16.5 cm, H: 48.5 cm, 230 V, 100 W, 3.5 kg	1	1	690.00	655.50
320 25 99	schwarz, 17 x 16.5 cm, H: 48.5 cm, 230 V, 100 W, 3.5 kg	1	1	690.00	655.50

ROTOR





Zitruspresse Profi

Zinkdruckguss verchromt, sehr stabile Ausführung
Müheloses Entsaften durch Hebelmechanismus, extra Ausgiesstülle für tropffreies Pressen, Sieb fängt Kerne und Fruchtfleisch auf, möbelschonende Gummifüsse

		Stück		
320 50 00	26 x 20 cm, H: 48 cm	1	1	165.00 132.00
				1 20 %



Elektrische Zitruspresse

Hartverchromtes Metallgehäuse, 2 Presskegel mit Flügelabstreifer, automatischer Anlauf durch Druck auf den Presskegel

		Stück		
320 34 00	17 cm Ø, H: 21 cm, 230 V, 80 W, 2.9 kg	1	1	168.00



Saft- und Zitruspresse

Einfach und schnell frischen Orangen-, Pampelmusen- oder Granatapfelsaft produzieren. Massives Gehäuse aus Aluguss, Saftbehälter, Presskegel und Siebeinsatz aus Edelstahl, abnehmbar, spülmaschineneignet, Automatische Aktivierung durch Schliessen des Hebelarms, Umdrehungen/Min.: 980, Ein-/Ausschalter

Gerät ist nicht für den dauerhaften gewerblichen Einsatz geeignet.

		Stück		
320 51 00	22 x 33 cm, H: 37.5 cm, 230 V, 230 W, 8.61 kg	1	1	388.00



Saft- und Zitruspresse Sunkist

Für den professionellen Einsatz im Gastgewerbe, in Kliniken und Diätküchen. Rüttelsieb aus CNS, 3 spezielle Presskegel für alle Zitrusfrüchte für eine maximale Saftextraktion. Motorgehäuse verchromt, schwere Qualität, Schutzhaube und Saftschale aus korrosionsfestem Kunststoff. Einfache Demontage und Reinigung, Ausstattung mit Motorschutzschalter und Kugellager.

		Stück		
320 49 00	21 cm Ø, H: 45 cm, Ausgusshöhe 22 cm, 1400 U/Min, 230 V, 190 W, 15 kg	1	1	1085.00 1030.75
				1 5 %



Eiswürfel-Behälter

Mantel CNS 18/10, mit Eiswürfelzange

		Stück		
310 10 00	2.2 l, H: 20 cm, 15 cm Ø	1	1	29.00



Eiswürfelschaufel CNS

Chromnickelstahl 18/10, gelocht

		Stück		
320 22 15	18x5 cm, H: 5 cm, 0.15 l	1	1	22.00 15.40
				1 30 %

Eiswürfel-Behälter Shine

CNS 18/10, mit Eiswürfelzange, schwere Qualität

		Stück		1
310 80 00	1 l, H: 16.3 cm, 15 cm Ø	1	1	99.50 89.55 10 %



Eisbox Maxi

Aluminium eloxiert

		Stück		1
310 11 50	5 l, H: 20 cm, 18.5 cm Ø	1	1	67.00 53.60 20 %
310 11 51	8 l, H: 20 cm, 27 cm Ø	1	1	94.00 75.20 20 %



Eiswürfel-Zange CNS

		Stück		1
310 12 00	Eiswürfel-Zange CNS, 18 cm	2	1	9.70 6.79 30 %



Ice Crusher

Manueller Zerkleinerer von Eiswürfeln

		Stück		1
320 05 00	12 x 12 cm, H: 24.5 cm	1	1	92.00 73.60 20 %



Ice Crusher Edelstahl

Ice Crusher mit Edelstahlgehäuse

Leistung 15 kg/h. Herausnehmbarer Vorratsbehälter für 1.75 kg Crush Ice. Mit 2 Sicherheitsschalter, Einfülltrichter und Auffangbehälter

		Stück		1
320 02 00	L x T: 17.2 x 24 cm, H: 46.3 cm, 230 V, 60-80 W, 1.75 kg	1	1	142.00 99.40 30 %



Ice Crusher

Professionelle Ice Crusher, elektrisch, mit herausnehmbarem Vorratsbehälter, verwandelt im Nu 1 kg Eis in Crushed Ice

		Stück		1
320 01 00	CNS, L x T: 17 x 38.5 cm, H: 40 cm, 230 V, 60 W, 16 kg	1	1	869.00
320 00 12	Santos, L x T: 23.6 x 35.3 cm, H: 47.4 cm, 230 V, 130 W, 10 kg	1	1	1686.00



Schaufel

Kunststoff, für Zucker, Mehl, Eiswürfel etc.

		Stück		1
320 20 10	weiss, 28.5 x 13 cm, H: 6.5 cm, 1 l	1	1	5.00
320 20 22	weiss, 36 x 14 cm, H: 9 cm, 2.2 l	1	1	9.30
320 21 00	transparent, 25 x 6 cm, H: 5 cm, 0.17 l	1	1	11.70



420.-



Eiswürfelmaschine Compact Ice

Stahlgraues Kunststoffgehäuse, Wahlschalter für 3 verschiedene Grössen der Eiswürfel, ohne Wassereinlauf und Ablauf, Tankfüllung von 4.5 l ergibt ca. 150 Eiswürfel

320 17 15	15 kg/24h, L x T: 36 x 44 cm, H: 45.4 cm, 230 V, 210 W, 23 kg	Stück	1	1	420.00
------------------	---	-------	---	---	--------

Eiswürfelmaschine

Einfache und zuverlässige Eisproduktion, Schaufelmaschinenserie ist für schwierigste Arbeitsbedingungen konzipiert, selbst bei hohen Wasserhärtegraden braucht man kein Filtersystem, Festwasseranschluss: 3/4", Wasserablauf, Kühlmittel: R404a, Füsse + 5 mm, Gehäuse aus Edelstahl, platzsparend und geräuscharm, mit Festwasseranschluss und Wasserablauf, Eiswürfel in Kegelform, Paddelsystem, mit Luftzirkulation (Abstand zu allen Seiten mind. 10 cm), Andere Modelle auf Anfrage



320 13 25	Eisvorrat 4.0 kg, 25 kg/24h, 38.5 x 46.8 cm, H: 60.7 cm, 230 V, 300 W, 36 kg	Stück	1	1	1950.00
------------------	--	-------	---	---	---------

Buffet-Kühlvitrine

Mit LED-Beleuchtung, 2 verstellbare, kunststoffbeschichtete Roste, 4-seitig doppelverglast, für Temperaturen von 0 bis + 12° C, Umluftkühlung



270 78 00	Inhalt: 100 Liter, 68.2 x 45 cm, H: 67.5 cm, 39 kg, 230 V, 160 W	Stück	1	1	1060.00 848.00
------------------	--	-------	---	---	---------------------------

Buffet-Kühlvitrine Deli-Cool

Mit LED-Beleuchtung, 2 verstellbare, kunststoffbeschichtete Roste, 4-seitig doppelverglast, für Temperaturen von 2 bis + 12° C, Umluftkühlung mit 2 Lüfter, automatische Abtaufunktion



270 88 00	Deli-Cool II, Inhalt: 120 Liter, 71 x 57.5 cm, H: 68.5 cm, 57 kg, 230 V, 160 W	Stück	1	1	1100.00
270 89 00	Deli-Cool III, Inhalt: 160 Liter, 88.5 x 57.5 cm, H: 68.5 cm, 68.4 kg, 230 V, 160 W	Stück	1	1	1220.00

Kühlvitrine

Beidseitig bedienbar durch Schiebetüren, Tragstruktur aus CNS, Doppelverglasung, mit LED-Beleuchtung und Umluftkühlung, automatischer Abtauprozess, 1 Rost verchromt 55.2 x 39 cm, Betriebstemperatur: 2° C bis + 8° C Innenmasse: 56.5 x 42 cm, H: 46 cm



270 92 00	91 x 51.5 cm, H: 46 cm, 53 kg, 230 V, 150 W	Stück	1	1	160.00
------------------	---	-------	---	---	--------

Kühlvitrinen

3 verstellbare, kunststoffbeschichtete Roste, Farbe weissmit Innenbeleuchtung für Temperaturen von + 4 bis +12°C Abtauautomatik, FCKW- und FKW-frei



270 76 00	Mini weiss, Inhalt: 78 Liter, 42.5 x 38 cm, H: 96 cm, 37 kg, 230 V, 180 W	Stück	1	1	585.00
270 76 99	Mini schwarz, Inhalt: 78 Liter, 42.5 x 38 cm, H: 96 cm, 37 kg, 230 V, 180 W	Stück	1	1	585.00
270 77 00	Maxi, Inhalt: 235 Liter, 52 x 48.5 cm, H: 170 cm, 77 kg, 230 V, 250 W	Stück	1	1	1425.00

Cocktail-Trinkhalme

5 mm Ø, 12.5 cm

	Stück	1	10	30
331 06 15 gelb, 12.5 cm, 5 mm Ø	1 1000	7.00	6.30 10 %	5.60 20 %
331 06 45 rot, 12.5 cm, 5 mm Ø	1 1000	7.00	6.30	5.60
331 06 55 grün, 12.5 cm, 5 mm Ø	1 1000	7.00	6.30	5.60
331 06 65 blau, 12.5 cm, 5 mm Ø	1 1000	7.00	6.30	5.60
331 06 99 schwarz, 12.5 cm, 5 mm Ø	1 1000	7.00	6.30	5.60



Trinkhalme

Biegsame Trinkhalme, ungehülst, Neon-farbig, assortiert

	Stück	1	10	30
330 10 25 5 mm Ø, 25 cm, Ungehülst	1 1000	12.00	10.80 10 %	9.00 25 %



Trinkhalme

Biegsame Trinkhalme, in, Papierhüllen, gestreift assortiert

	Stück	1	10	30
330 00 25 5 mm Ø, 25 cm	1 1000	17.00	15.30 10 %	12.75 25 %



Jumbo Trinkhalme

gestreift, assortiert

	Stück	1	10	30
330 16 25 7 mm Ø, 25 cm	1 1000	19.80	17.82 10 %	14.85 25 %



Jumbo Trinkhalme

schwarz

	Stück	1	10	30
330 19 20 8 mm Ø, 20 cm	1 1000	17.00	15.30 10 %	12.75 25 %
330 18 25 8 mm Ø, 25 cm	1 1000	26.50	23.85	19.88



Retro-Trinkhalme

Die rot/weiß gestreiften und biegsamen Papier-Trinkhalme im Look der 50er Jahre verleihen jedem Drink das gewisse Extra. Die Bio-Trinkhalme werden Ihre Gäste begeistern - sowohl durch ihren Stil als auch durch die Umweltfreundlichkeit.

	Stück	1	10	30
331 07 20 6 mm Ø, 19.5 cm	1 100		12.40	9.92 20 %



Trinkhalme

	Stück	1	5	10
330 43 23 Palme, 23 cm	1 250 100 =	30.00 11.92	27.00 10 % 10.73	24.00 20 % 9.54



Bar-Caddy

Kunststoff schwarz, Ordnungshilfe für Trinkhalme, Servietten, Rührer usw.

	Stück	1	1	1
310 51 00 24 x 15 cm, H: 11 cm	1 1		18.00	14.40 20 %





Trinkhalm-Löffeli

		Stück	1	12
179 12 00	22 cm, 5 mm Ø	1 50	14.00	11.90 15 %

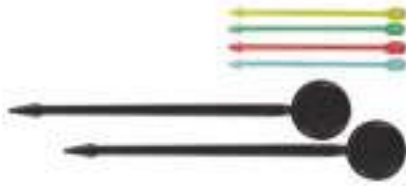

Picker

		Stück	1	5	10
330 29 08	Apéro, 8.5 cm	1 1000	12.90	11.61 10 %	10.32 20 %
330 32 16	Rondus, 16.3 cm	1 1000	56.00	50.40	44.80

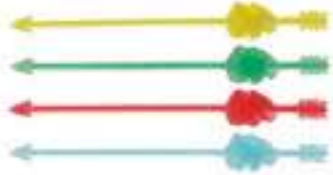

Picker

		Stück	1	10	20
330 38 16	Amor, 16 cm	1 1000	62.00	55.80 10 %	49.60 20 %

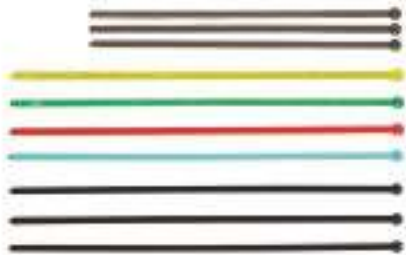

Longdrink-Sticks

		Stück	1	5	10
330 31 15	Quadro, fumé, 15 cm	1 1000	56.00	50.40 10 %	44.80 20 %
330 41 22	Quadro long, assortiert, 22 cm	1 500	33.00	29.70 10 %	26.40 20 %
		100 =	6.60	5.94	5.28
330 41 99	Quadro long, schwarz, 22 cm	1 500	33.00	29.70	26.40



Holz-Zahnstocher

		Stück	1	25	50
330 20 00	hulu-Hülle, 68 mm, 2 mm Ø	1 1000	4.90	4.41 10 %	3.92 20 %
330 21 00	Neutrale Hülle, 68 mm, 2 mm Ø	1 1000	5.90	5.31	4.72



hulu Dental-Zahnstocher

V-Form, schont das Zahnfleisch, Medizinal-Zahnstocher in Keilform, einzeln in Cellophan-Hülle, mit Pfefferminz-Geschmack, einseitig gespitzt

		Stück	1	50
330 23 00*	50 mm	1 1000	36.00	18.00 50 %



Offene Zahnstocher

Holz, beidseitig gespitzt, rund, auch zum Zusammenstecken und -halten von Fleischstücken wie z.B. Cordon bleu, Fleischvögel etc.

		Stück	1	6	12
330 25 00	68 mm, 2 mm Ø	1 5000	9.90	8.91 10 %	7.92 20 %
		1000 =	1.98	1.78	1.58



Bambus-Picker / Spiesse Satay

		Stück	1	6	12
330 26 09	Bambus-Picker Schlaufe, 9 cm	1 2000	79.00	71.10 10 %	63.20 20 %
		1000 =	39.50	35.55	31.60
330 26 10	Bambus-Picker Schlaufe, 9 cm	1 100			4.90
330 27 12	Spieß Satay, 12 cm	1 2000	69.00	62.10 10 %	55.20 20 %
		1000 =	34.50	31.05	27.60
330 27 13	Spieß Satay, 12 cm	1 100			3.90

Weinausgiesser

Nie mehr Weintropfen auf dem Tischtuch

		Stück			
300 00 00	Drop Stop, 7.6 cm Ø	1	10	22.00	17.60
					20 %
300 02 00	Wine Server Crystal	1	2	7.50	6.75
					10 %



Kapselheber

9 cm
10 Stück

		Stück			
300 36 00	9 cm	1	10		7.00
			1 =		0.79



Pulltex Korkenzieher

Der doppelte Hebel des Pulltap's Korkenziehers hat das Weinentkorken revolutioniert. Die langen Korken können ohne Kraftaufwand in zwei Stufen gezogen werden, ohne Beschädigung, Spirale aus Teflon®

Pulltex®

		Stück	1	10	20
300 42 99		1	1	16.00	14.40
					5 %



Korkenzieher Wood

Profi-Korkenzieher mit Doppelheberprinzip, Holzgriff, Spirale aus Teflon

		Stück	1	6	12
300 44 00		1	1	16.00	14.40
					10 %



Korkenzieher

Korkenzieher mit Doppelheberprinzip eignet sich auch für grosse Flaschen, 12 cm

		Stück	1	6	12
300 40 10		1	1	6.80	6.12
					10 %



Kellner-Messer Standard

		Stück	1	6	12
300 37 00	12 cm	1	1	6.80	6.46
					5 %



Flaschen-Entkorker

Qualitäts-Produkt, Spritzguss vernickelt mit Schraubklemmen, für Tische oder Konsolen

		Stück			
300 56 00		1	1	86.00	68.80
					20 %



Vacu-Vin-Pumpe

Angebrochener Wein bleibt tagelang frisch. Zum Abpumpen der Luft aus der angebrochenen Flasche, inklusive 4 Verschlusszapfen

		Stück			
282 18 00	Vacu-Vin-Pumpe	1	1		24.95
282 18 50	Verschlusszapfen	1	2		5.90
			1 =		2.95





Service-Tücher

47 x 60 cm, Schweizer Halbleinen, gebleicht, eingewobene Seitenstreifen mit zweifacher Aufschrift

		Stück	1	4	8
300 30 02	blau	1 10	45.00	40.50 10 %	36.00
300 30 01	rot	1 10	45.00	40.50	36.00



Flaschenhalter

Für 7.5 dl-Flaschen, umgedreht für 3/8 l und 5 dl-Flaschen

		Stück	1	20 %	1
300 12 00	Vino, 8.8 x 26 cm, H: 18 cm	1 1		9.90	7.92



Flaschenkühler Ice Bag

Modern und innovativ präsentiert sich der Ice Bag Flaschenkühler. Hergestellt aus wasserdichtem und wiederverwertbarem PVC, hebt sich völlig vom traditionellen Bild eines Flaschenkühlers ab. Materialstärke 0.5 mm

		Stück	1	12	30
300 19 00	11 x 11 cm, H: 26 cm	6 1	8.50	7.65 10 %	6.80



Weinkühler Copper

Hammerschlagoptik, doppelwandig für beste Isolierung. Edelstahl, aussen verkupfert und anlaufgeschützt, nicht spülmaschinengeeignet

		Stück	1	6	12
310 09 00	12 cm Ø, H: 20 cm	1 1	40.00	36.00 10 %	32.00

Trocken-Flaschenkühler

Die feste, doppelwandige Isolierung hält die Flasche während mehr als einer Stunde kühl



		Stück	1	6	12
300 15 01	Acryl, für Flaschen: 3.5 - 7 dl, 11 cm Ø, H: 18.5 cm	1 1		19.00	15.20
300 15 02	Acryl, für Flaschen: 7 dl - 1l, innen 10 cm, 13 cm Ø, H: 23 cm	1 1		13.00	10.40
300 16 02	CNS, für Flaschen: - 7 dl, 10 cm Ø, H: 19 cm	1 1	32.00	30.40 5 %	28.80
300 16 00	CNS, für Flaschen: 7 dl - 1l, 12 cm Ø, H: 20 cm	1 1	34.00	32.30	30.60

Weinkühler Beton

Beton Weinkühler mit hervorragender Kühlung, mit Schonfilz auf der Unterseite

		Stück	1	6	12
310 08 00	12 cm Ø, H: 19 cm	1	1	27.00	24.30 10 % 21.60 20 %



Rapid Ice

Aktiver Schnellkühler. Kühlt eine Flasche in nur 5 Minuten von Zimmertemperatur auf herrliche Frische, hält die Flasche noch stundenlang kalt. Bewahren Sie Rapid Ice in der Gefriertruhe auf.

		Stück	1	6	12
300 21 00	Rapid Ice Schnellkühler, 10 cm Ø	1	1	14.50	13.78 5 % 13.05 10 %



Prestige Wine Cooler

Der Prestige Wine Cooler von Vacu Vin kühlt Wein sofort - ohne Eis! Der Prestige Cooler zeichnet sich durch das wieder verwendbare Rapid Ice Kühlelement aus, das Ihre Weinflasche von Raumtemperatur in 5 Minuten kühlt und die Flasche für Stunden kühl hält.

		Stück	1	6	12
300 20 00	Schwarz, H: 20.5 cm, 15 cm Ø	1	1	24.90	23.66 5 % 22.41 10 %
300 20 01	CNS, H: 20.5 cm, 15 cm Ø	6	1	49.00	46.55
300 21 00	Rapid Ice Schnellkühler, 10 cm Ø	1	1	14.50	13.78



Wein-, Champagnerkühler Excellent

CNS 18/10, schwere Qualität, für 1 Flasche

		Stück	1	6	12
300 75 00	H: 21 cm, 17 cm Ø	1	1	168.00	151.20 10 %
300 76 00	H: 22 cm, 19 cm Ø	1	1	184.40	165.96



Wein-, Champagnerständer Excellent

CNS 18/10

		Stück	1	6	12
300 77 00	rund, für 1 Flasche, H: 68 cm, 16.2 cm Ø	1	1	299.50	269.55 10 %
300 79 00	oval, für 2 Flaschen, H: 67 cm, 24 x 17 cm	1	1	540.00	486.00



Wein-, Champagnerkühler oval Excellent

CNS 18/10, schwere Qualität, für 2 Flaschen

		Stück	1	6	12
300 78 00	H: 21 cm, 27 x 22 cm	1	1	437.00	393.30 10 %





Wein-, Champagnerkühler

Wein-, Champagnerkühler in Hammerschlag-Optik

Edelstahl hochglanzpoliert, mit massiven Griffen, Rand eingerollt, spülmaschinengeeignet

		Stück			
300 43 00	H: 21.5 cm, 21 cm Ø	1	1	26.00	20.80 ¹ 20 %



Wein-, Champagnerkühler Vintage CNS

Hochglänzend mit Knopfgriffen

		Stück			
300 22 00	H: 20 cm, 21 cm Ø	1	1	74.00	59.20 ¹ 20 %



Wein-, Champagnerkühler CNS

		Stück			
300 25 00	Mit Ringgriffen, H: 19 cm, 19 cm Ø	1	1	34.00	27.20 ¹ 20 %
300 24 00	Mit Tulpengriffen, H: 21 cm, 21 cm Ø	1	1	25.00	20.00 ¹ 20 %
300 23 00	mit Knopfgriffen, H: 22 cm, 21.5 cm Ø	1	1	33.00	29.70 ¹ 10 %



Tischhalter für Wein-, Champagnerkühler

		Stück	1	3	6
300 27 01	18.5 cm Ø	1	1	21.00	19.95 ³ 5 % ⁶ 10 %



Wein-, Champagnerständer

CNS 18/10, poliert

		Stück			
300 28 01	H: 65 cm, 16.5 cm Ø	1	1	115.00	103.50 ¹ 10 %



Champagnerschüssel Acryl

Aus Acrylglas mit verchromtem Fuss

		Stück			
310 01 00	10 l, H: 25 cm, 40 cm Ø	1	1	66.00	59.40 ¹ 10 %

Champagnerschüssel poliert

Aus poliertem CNS 18/8

		Stück		
310 00 00	13.5 l, H: 24 cm, 37 cm Ø	1	1	99.00
				1 30 % 69.30



Champagnerschüssel Apart

Champagnerschüssel mit poliertem Edelstahl, doppelwandig, der Champagner und das Eis bleiben deshalb länger kühl, praktisch keine Kondenswasserbildung mehr

		Stück		
310 01 10	10.5 l, H: 24 cm, 44 cm Ø	1	1	164.00
				1 20 % 131.20



131,20

Champagnerschüssel Champion

CNS 18/8, hochglanzpoliert

Die Champagnerschüssel Champion ist doppelwandig und bildet kein Kondenswasser! Auch deshalb bleibt der Champagner und das Eis länger kühl

		Stück		
310 02 00	15 l, 44 cm Ø, H: 32 cm	1	1	539.00
				1 20 % 431.20



Champagner-Flaschenverschluss

Hermetischer Verschluss, für angebrochene Champagner-Flaschen
2er Set

		Stück		
310 06 02	H: 6 cm, 4 cm Ø	1	2	13.00
				5.95



**1 Stück
6,50**

Champagner-Saver Vacu Vin

Bewahrt die natürlichen Bläschen, minimiert die Oxydation, Geruch und Geschmack bleiben bis zu einer Woche erhalten. Spezieller Tropfenstop, Tropfen fließen durch ein einfaches Abflusssystem zurück in die Flasche

		Stück		
310 07 00	7.6 cm	1	1	13.50



Champagner-Flaschenverschluss

Hermetischer Verschluss, für angebrochene Champagner-Flaschen

		Stück		
310 06 00	9 cm	1	1	26.90



Buffet

abert...

Blue Flame

EDINGER
KÜCHENGERÄTE

hoist

premi Star

Tognana

APS
WITTEN

Best

FIGGIO
KÜCHEN

hub

Recht Koch

WESBO AG

Arcoroc
IMPROFESSIONE

bodum

fellos

Kisag

Seltmann
Wieder

WECK

Bartscher

Dinetray®

HEPP

Luminarc

Servitray®

SPIEGELAU

BLANCO

Durobor

Lega Perini
ITALY

PEUGEOT
la griffe savante

Spring...

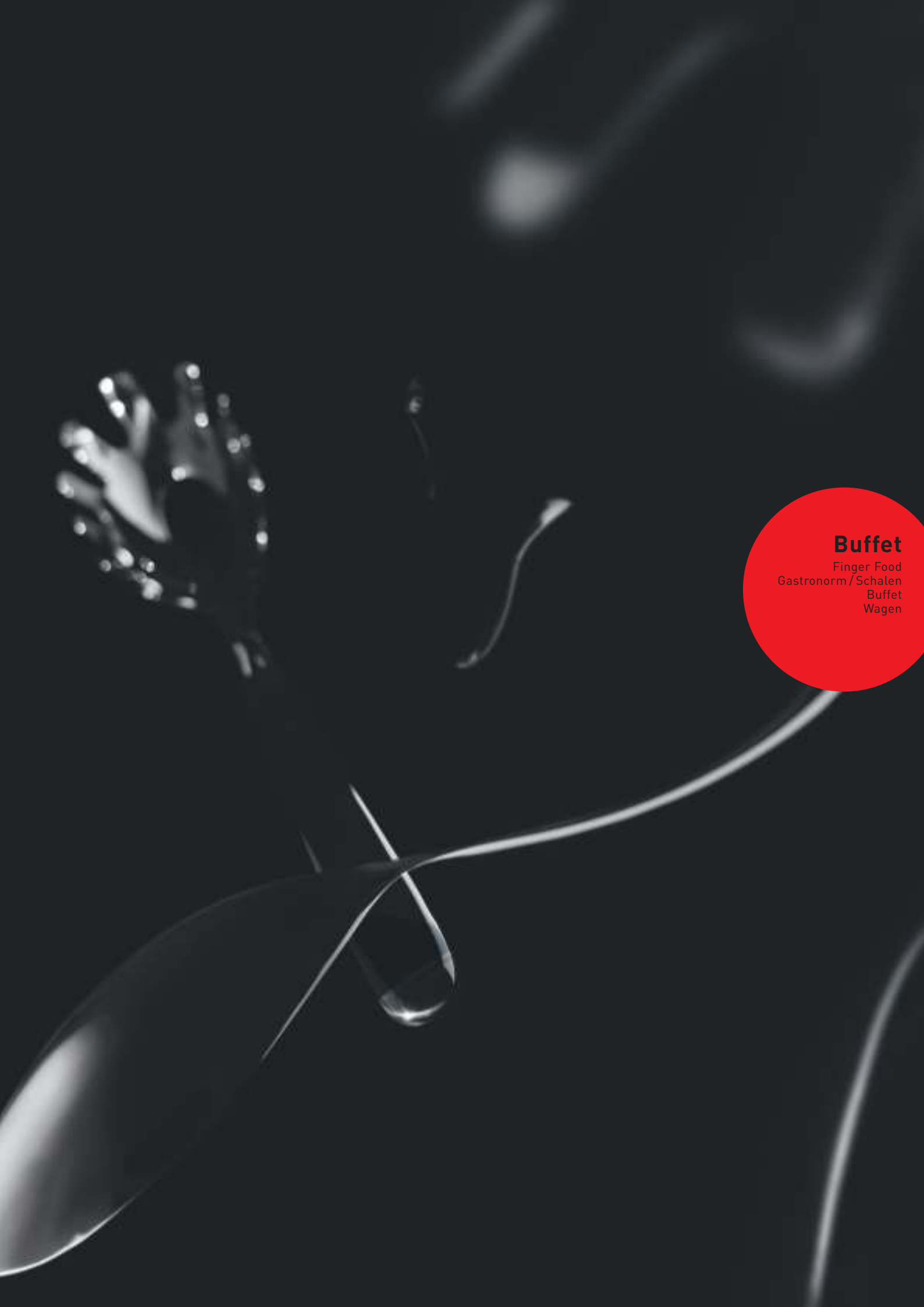

Buffet

Finger Food
Gastronorm/Schalen
Buffet
Wagen



HOTEL

Buffet Gourmet



Buffet

Buffet Gourmet - Seltmann Weiden Porzellan

(%) Mengenrabatte innerhalb der Marke Seltmann, auch gemischt

Schalen quadratisch Buffet Gourmet

	Stück	1	60	120
			10 %	20 %
115 887 34 11 x 11 cm, H: 5 cm, 0.26 l	4	1	10.30	9.27 8.24
115 902 05 15 x 15 cm, H: 6 cm, 0.6 l	2	1	11.40	10.26 9.12
115 887 59 17 x 17 cm, H: 6 cm, 0.85 l	2	1	15.70	14.13 12.56
115 902 55 20 x 20, H: 7 cm, 1.4 l	1	1	20.30	18.27 16.24
115 906 30 23 x 23 cm, H: 8.5 cm, 2.2 l	1	1	26.80	24.12 21.44
115 906 55 26 x 26 cm, H: 10 cm, 3.6 l	1	1	37.70	33.93 30.16



Schalen Buffet Gourmet

	Stück	1	60	120
			10 %	20 %
115 900 02 10 x 10, H: 5 cm, 0.18 l	4	1	10.60	9.54 8.48
115 895 43 10 x 10, H: 7 cm, 0.23 l	2	1	11.60	10.44 9.28
115 894 93 10 x 20 cm, H: 7 cm, 0.6 l	2	1	18.10	16.29 14.48
115 899 49 16 x 16 cm, H: 5 cm, 0.6 l	1	1	16.50	14.85 13.20
115 894 68 16 x 16 cm, H: 7 cm, 1 l	1	1	19.20	17.28 15.36
115 894 43 20 x 20 cm, H: 5 cm, 1.5 l	1	1	22.90	20.61 18.32



Schüsseln rund Buffet Gourmet

	Stück	1	60	120
			10 %	20 %
116 822 50 18 cm Ø, H: 8 cm, 0.4 l	4	1	32.40	29.16 25.92
116 822 51 24 cm Ø, H: 11 cm, 0.95 l	2	1	42.00	37.80 33.60
115 903 05 28 cm Ø, H: 11 cm, 0.92 l	1	1	47.70	42.93 38.16
115 902 80 30 Ø, H: 15 cm, 2.12 l	1	1	52.30	47.07 41.84



Platten Buffet Gourmet

	Stück	1	60	120
			10 %	20 %
115 895 93 Platte, 10 x 10 cm	2	1	8.60	7.74 6.88
115 896 46 Platte, 10 x 20 cm	2	1	13.80	12.42 11.04
115 896 96 Platte, 20 x 20 cm	2	1	20.30	18.27 16.24
115 897 71 Platte, 16 x 16 cm	2	1	16.70	15.03 13.36
116 594 26 Platte, 23 x 23 cm	1	1	28.00	25.20 22.40
116 594 27 Platte, 32.5 x 10.8 cm	1	1	28.00	25.20 22.40
116 594 28 Platte, 32.5 x 22.4 cm	1	1	33.40	30.06 26.72
116 594 29 Platte, 32.5 x 32.5 cm	1	1	45.80	41.22 36.64



Platten Buffet Gourmet

	Stück	1	60	120
			10 %	20 %
115 903 30 Platte, 16 x 16 cm	2	1	17.70	15.93 14.16
115 904 05 Platte, 25 x 25 cm	2	1	31.10	27.99 24.88
115 905 30 Platte, 35 x 25 cm	1	1	36.90	33.21 29.52
115 912 83 Platte, 25 x 14 cm	2	1	23.80	21.42 19.04
115 905 80 Platte, 35 x 35 cm	1	1	50.60	45.54 40.48
115 905 05 Platte, 35 x 14 cm	1	1	29.30	26.37 23.44



GN-Platten Buffet Gourmet

	Stück	1	60	120
			10 %	20 %
117 000 89 GN: 2/4, 53 x 16.2 cm	2	1	61.10	54.99 48.88
117 000 88 GN: 1/3, 32.5 x 17.5 cm	3	1	34.50	31.05 27.60
117 000 87 GN: 1/2, 32.5 x 26.5 cm	2	1	49.90	44.91 39.92
117 000 86 GN: 1/1, 53 x 32.5 cm	1	1	85.00	76.50 68.00





HOTEL

Buffet Plus



Buffet

Schalen Buffet Gourmet

		Stück	1	60	120	
				10 %	20 %	
115 915 08	6 x 6 cm, H: 4 cm, 0.05 l	6	1	7.10	6.39	5.68
115 906 80	10 x 10 cm, H: 4 cm, 0.16 l	2	1	9.80	8.82	7.84
115 901 05	20 x 5 cm, H: 4 cm, 0.14 l	1	1	11.50	10.35	9.20
115 915 83	20 x 10 cm, H: 4 cm, 0.32 l	2	1	17.30	15.57	13.84
115 901 55	30 x 5 cm, H: 4 cm, 0.21 l	1	1	14.50	13.05	11.60



Salatsaucentöpfe Buffet Gourmet

		Stück	1	60	120	
				10 %	20 %	
115 899 24	Salatsaucentopf, 1 l	1	1	25.30	22.77	20.24
115 914 58	Salatsaucentopf, 1.5 l	1	1	41.30	37.17	33.04



Buffet Plus - Seltmann Weiden Porzellan

(%) Mengenrabatte innerhalb der Marke Seltmann, auch gemischt

Schalen dreieckig Buffet Plus

		Stück	1	60	120	
				10 %	20 %	
116 978 93	Schale, 11 cm, H: 2.4 cm	4	1	11.60	10.44	9.28
116 978 94	Schale, 20 cm, H: 2.7 cm	2	1	25.00	22.50	20.00
116 978 95	Schale, 26 cm, H: 3.5 cm	2	1	37.90	34.11	30.32
116 978 96	Schale, 31 cm, H: 4.2 cm	2	1	46.60	41.94	37.28
116 978 97	Schale, 38 cm, H: 5.3 cm	2	1	58.40	52.56	46.72



Schale hoch Buffet Plus

		Stück	1	60	120	
				10 %	20 %	
116 978 92	Schale, 31 cm, H: 5.7 cm	2	1	48.90	44.01	39.12



Schüsseln dreieckig Buffet Plus

		Stück	1	60	120	
				10 %	20 %	
116 979 00	9.5 cm, H: 4.4 cm, 0.15 l	4	1	12.30	11.07	9.84
116 979 06	11 cm, H: 6.8 cm, 0.32 l	2	1	18.90	17.01	15.12
116 979 01	15 cm, H: 4.8 cm, 0.37 l	2	1	13.30	11.97	10.64
116 979 02	19 cm, H: 7.7 cm, 1 l	2	1	31.50	28.35	25.20
116 979 03	23 cm, H: 8.9 cm, 1.75 l	2	1	42.50	38.25	34.00
116 979 04	28 cm, H: 10.8 cm, 3.25 l	2	1	48.90	44.01	39.12
116 979 05	38 cm, H: 15 cm, 8 l	1	1	78.80	70.92	63.04



Buttertöpfe

Porzellan, weiss, Inhalt 25g



			Stück	1	36	72
131 19 07	Piano, 7.2 cm Ø, H: 2.3/3 cm	6	1	4.90	3.43	30 %
131 38 00	Beurrier, 6.5 cm Ø, H: 3 cm	6	1	5.20	4.68	10 %
131 39 07	Cooler, 7 cm Ø, H: 2.5 cm	6	1	5.30	4.77	20 %

Buttertopf-Papiere

Weiss, fett dicht



			Stück	1	36	72
106 90 01	60 mm Ø	1	500 1000 =	8.50 17.00	8.08 16.15	7.65 15.30

Buttertöpfe mit Cloche



			Stück	1	36	72
131 39 00	Cloche aus Porzellan, 9 cm Ø, H: 7.5 cm	6	1	7.90	4.74	40 %
131 40 00	Cloche aus CNS, 9 cm Ø, H: 7 cm	6	1	16.00	12.80	20 %

Saucenschalen

Porzellan, weiss



			Stück	1	36	60
131 91 07	6.8 cm Ø	12	1	1.90	1.71	1.52
131 91 08	8.1 cm Ø	12	1	2.60	2.34	2.08

Mini-Formen Appetizer



			Stück	1	36	72
136 01 09	Mini-Plättchen quadratisch, 9,5 x 9,5 cm	6	1	2.70	2.43	2.16
136 04 14	Mini-Plättchen, 14 x 10 cm	6	1	2.70	2.43	2.16

Mini Teller Linea

ab
1.47



			Stück	1	36	72
131 99 07	Mini Teller Linea, 7 cm Ø	6	1	2.10	1.47	30 %
131 99 09	Mini Teller Linea, 9 cm Ø	6	1	2.50	1.75	

Mini-Formen Appetizer



			Stück	1	36	72
136 03 10	Mini-Schälchen oval, 10 x 7.3 cm, H: 4.5 cm	6	1	2.70	2.43	2.16
136 01 14	Mini-Plättchen rechteckig, 14.5 x 7 cm	6	1	2.70	2.43	2.16
136 05 08	Mini-Schälchen tief quadr., 8.5x8.5cm, H:4cm	6	1	2.70	2.43	2.16
136 05 10	Mini-Schälchen tief, 10 cm Ø	6	1	2.70	2.43	2.16
136 02 09	Mini-Schälchen konisch, 9.8 x 9.5 cm, H: 6.8 cm	6	1	2.70	2.43	2.16

Buffet

Pasteten-/Ramequinformen

		Stück	1	25	50
				10 %	20 %
132 01 07	6.5 cm Ø, H: 3.6 cm	6	1	2.50	2.25 2.00
132 01 08	7.5 cm Ø, H: 3.8 cm	6	1	3.00	2.70 2.40
132 01 09	8.5 cm Ø, H: 4 cm	6	1	3.80	3.42 3.04
132 01 10	10 cm Ø, H: 5.3 cm	6	1	3.80	3.42 3.04



ab
2.-

premiStar

Ramequinform Lyon

		Stück	1	36	72
				10 %	20 %
132 19 09	8.5 cm Ø, H: 4 cm, 14 cl	4	1	1.70	1.53 1.36



Cup Cakes/Tapas Förmchen Rainbow

Bunte Cup Cakes/Tapas Förmchen Rainbow im 6er Set assortiert.

		Stück	1		1
					20 %
131 76 06	6.7 cm Ø, H: 3.1 cm	1	6	19.00	15.20 2.23
131 76 07	7.5 cm Ø, H: 5 cm	1	6	25.00	20.00 2.75
131 76 10	10 cm Ø, H: 2.5 cm	1	6	27.00	21.60 3.05



Finger Food Hit

		Stück	1	36	72
				10 %	20 %
136 07 11	Tropfen Schale, 11 x 8 cm, H: 5 cm	8	1	3.50	3.15 2.80
136 06 10	Rechteckige Schale, 11 x 7 cm, H: 4 cm	8	1	3.50	3.15 2.80
136 07 10	Eierform Schale, 10 x 8 cm, H: 4 cm	8	1	3.50	3.15 2.80



Miniformen

Porzellan, weiss

		Stück	1	36	72
				5 %	10 %
132 03 07	Mini-Eierpfännchen, 8.7 x 7 cm	18	1	3.50	3.33 3.15



Bowls Conical

Porzellan, weiss

		Stück	1	48	96
				10 %	20 %
132 27 07	7 cm Ø, H: 4.4 cm	24	1	4.50	4.05 3.60
132 27 08	8 cm Ø, H: 6 cm	24	1	5.20	4.68 4.16



Miniformen

Porzellan, weiss

		Stück	1	30	60
				5 %	10 %
132 01 06	Mini-Ramequinform, 6 cm Ø, H: 3.5 cm	6	1	3.10	2.95 2.79
131 20 00	Mini-Löwenkopf-Terrinchen, 8 cm Ø, H: 5.5 cm, 0.9 dl	10	1	3.70	3.52 3.33



Dip-Cup Teardrops

Porzellan, weiss

		Stück	1		1
					20 %
134 24 11	10.8 x 7.9 cm, H: 2.6 cm	6	1	3.90	3.12





Bubble

		Stück	1	36	72
178 08 05	7.6 cm Ø, H: 6 cm, 5 cl, Mini Bubble	6	1	2.80	2.24
				10 %	20 %



Amuse Bouches Figuras

		Stück	1	36	72
171 42 14	Cube, 14 cl, H: 6 cm, 5.6 cm Ø	6	1	2.30	1.84
171 43 15	Cylinder, 15 cl, H: 6 cm, 6.2 cm Ø	6	1	2.30	1.84
171 44 15	Triangle, 15 cl, H: 6 cm	6	1	2.30	1.84
171 45 15	Oval, 15 cl, H: 6 cm, 5.2 x 7.2 cm	6	1	2.30	1.84
				10 %	20 %

Slide Control

Mit Silikonring auf Unterseite

Slide Control ermöglicht ein sicheres Servieren ohne Rutschen und Klackern



		Stück	1	60	120
170 87 06	Trek, 6 cl, H: 6.1 cm, 5.2 cm Ø	6	1	2.50	2.00
170 87 08	Aroma, 8 cl, H: 6.5 cm, 7.6 cm Ø	6	1	3.00	2.40
170 87 16	Baril, 16 cl, H: 8 cm, 5.8 cm Ø	6	1	2.30	1.84
				10 %	20 %



Amuse Bouches Arkade

		Stück	1	36	72
178 00 11	Atoll, 11 cl, H: 5.5 cm, 6.3 cm Ø	6	1	2.20	1.76
178 02 12	Carat, 12 cl, H: 5.5 cm, 6 cm Ø	6	1	2.20	1.76
				10 %	20 %



Eierkoch Edition Wilhelm Wagenfeld

Der von Wilhelm Wagenfeld für Jenaer-Glas entworfene Eierkoch besticht durch unverwechselbare Form und Robustheit. Für Eier im Glas und weitere Rezepte wie Süßspeisen und Pasteten eignet er sich hervorragend.

		Stück	1	18	36
178 07 06	No. 1, 65 ml, 72 x 65 mm, H: 86 mm	1	1	13.80	10.35
178 07 13	No. 2, 130 ml, 89 x 82 mm, H: 86 mm		1	17.50	13.13
				10 %	25 %



Amuse-bouche

		Stück	1	36	72
178 04 06	Rocks, 6 cl, 4 cm Ø, H: 7 cm	6	1	2.60	2.08
				10 %	20 %



Holz-Schnapsplatte für 6 Gläser (ohne Gläser)

Hoch die Gläser!

Erst recht, wenn sie in der Miniversion daherkommen und auf einer originellen Schnapsplatte gereicht werden. Ein amüsantes Accessoire für die lustige Runde.

		Stück	1	36	72
252 32 54	53.5 x 6 cm, Höhe von der Schnapsplatte 2 cm	1	1	13.80	16.00
170 68 02	Kirschglas mit Filet, : 2 cl, 45 mm Ø, H: 70 mm, 32 ml	6	1	1.60	1.28
178 04 06	Shotglas Rocks, 6 cl, 4 cm Ø, H: 7 cm	6	1	2.60	2.08
				10 %	20 %

Buffet

Amuse Bouches Dom

		Stück	1	24	48
				10 %	20 %
141 21 08	8 cm Ø, H: 8 cm	4	1	10.70	9.63 8.56
141 21 11	11 cm Ø, H: 10.5 cm	4	1	19.40	17.46 15.52



Amuse Bouche Gem

		Stück	1	60	120
				10 %	20 %
140 79 12	12 cl, H: 8.5 cm, 7.1/9.3 cm Ø	6	1	2.30	2.07 1.84



Amuse Bouches Boutique

		Stück	1	60	120
				10 %	20 %
140 76 00	konisch, 8.2 cm Ø, H: 3.5 cm	6	1	1.00	0.90 0.80
140 76 01	konisch, 10 cm Ø, H: 4.5 cm	6	1	1.20	1.08 0.96
140 76 02	oval mit Griff, 9.7 cm Ø, H: 3 cm	6	1	0.90	0.81 0.72
140 76 03	Schiffchen, 9.6 cm Ø, H: 3.5/5 cm	6	1	0.80	0.72 0.64
140 76 04	Schiffchen, 11 cm Ø, H: 3.5/5 cm	6	1	0.80	0.72 0.64



ab
- .64

Becher Caravelle

		Stück	1	60	120
				10 %	20 %
161 59 15	159 ml, H: 7.9 cm, 6.5 cm Ø	6	1	1.00	0.90 0.80



Amuse Bouche Traditional

		Stück	1	60	120
				10 %	20 %
170 99 11	10.5 cl, H: 6.3 cm, 6.3 cm Ø	12	1	1.30	1.17 1.04



Amuse Bouches Shot

		Stück	1	60	120
				10 %	20 %
170 98 11	11 cl, H: 9.7 cm, 5.8 cm Ø	12	1	3.50	3.15 2.80
170 98 13	13 cl, H: 7.9 cm, 7 cm Ø	12	1	3.30	2.97 2.64



Finger Food

		Stück	1	60	120
				10 %	20 %
170 69 06	Islande, 65 ml, H: 105 mm, 35 mm Ø	12	1	0.80	0.72 0.64
170 69 07	35 mm Ø, H: 105 mm, 65 ml, Islande satiniert	12	1	2.20	1.98 1.76



Amuse Bouches Trivial

		Stück	1	36	72
				10 %	20 %
178 12 11	4.7 x 6.5 cm Ø, Ellipse, 11 cl, H: 6.5 cm	6	1	2.10	1.89 1.68
171 13 15	6.9 cm Ø, Disco, 15 cl, H: 7 cm	6	1	2.00	1.80 1.60





Gläser Michelangelo/Chopin

Doppelwandiges Borosilikatglas

		Stück	1	12	30
178 09 11	Michelangelo , 11 cl, H: 6.7 cm, 6 cm Ø,	2	1	6.70	4.02
178 10 11	Chopin, 11 cl, H: 6.9 cm, 7.4 cm Ø	2	1	6.70	4.02



Glas Silhouette

Doppelwandiges Borosilikatglas

		Stück	1	12	30
178 00 10*	Silhouette, 100 ml, H: 85 mm, 55 mm Ø	6	1	11.00	9.90



Glas Canteen

Doppelwandiges Borosilikatglas mit isolierender Wirkung für heisse und kalte Getränke sowie Desserts und Fingerfood

		Stück	1	12	30
141 16 01	Canteen, 100 ml, H: 73 mm, 72 mm Ø	2	1	10.60	7.42



Glas Pilatus

Doppelwandiges Borosilikatglas mit isolierender Wirkung für heisse und kalte Getränke sowie Desserts und Fingerfood

		Stück	1	12	30
141 17 01	Pilatus, 80 ml , H: 65 mm, 62 mm Ø	2	1	11.60	8.12



Gläser Pavina/Assam

Doppelwandiges Borosilikatglas

		Stück	1	12	30
141 11 01	Pavina, 80 ml, H: 65 mm, 60 mm Ø	2	1	10.60	7.42
141 10 01	Assam, 100 ml, H: 72 mm, 67 mm Ø	2	1	10.60	7.42

ab
2.64



Einmachgläser Fido

		Stück	1	12	30
171 50 01	0.125 l, H: 7 cm	6	1	3.30	2.97
171 50 02	0.2 l, H: 8.5 cm	6	1	3.50	3.15
171 50 05	0.5 l, H: 10 cm	6	1	3.70	3.33
171 50 08	0.75 l, H: 13.5 cm	6	1	4.40	3.96
171 50 10	1.0 l, H: 16 cm	6	1	4.80	4.32
171 50 15	1.5 l, H: 22 cm	6	1	5.30	4.77
171 50 20	2 l, H: 21.6 cm	6	1	5.80	5.22



Naturschieferplatte

Mit 3 Vertiefungen 5.5 cm Ø, für Weckgläser 178 06 08 und 178 06 14

Nicht spülmaschinengeeignet

		Stück	1	12	30
252 27 28	28 x 10 cm	1	1	9.80	8.82

Buffet

Weck Einmachgläser mit Deckel

		Stück	1	36	72
				10 %	20 %
178 06 08	Mini-Einmachglas mit Deckel, 8 cl, : 5.5 cm, 6 cm Ø	12	1	1.90	1.71 1.52
178 06 14	Midi-Einmachglas mit Deckel, 14 cl, H: 6.9 cm, 6 cm Ø	12	1	2.40	2.16 1.92
178 06 16	Mini-Einmachglas mit Deckel, 16 cl, H: 8 cm, 6 cm Ø	12	1	2.40	2.16 1.92
178 06 29	Midi-Einmachglas mit Deckel, 29 cl, H: 8.7 cm, 8 cm Ø	6	1	2.40	2.16 1.92
178 06 22	Mini-Tulpenglas mit Deckel, 22 cl, H: 8 cm, 6 cm Ø	12	1	2.40	2.16 1.92



Weck Sturzgläser mit Deckel

		Stück	1	36	72
				10 %	20 %
178 16 17	Sturzglas mit Deckel ,16.5 cl, H: 4.7 cm, 8 cm Ø	12	1	2.40	2.16 1.92
178 16 20	Sturzglas mit Deckel, 20 cl, 8 cm Ø, H: 6 cm,	12	1	2.60	2.34 2.08
178 16 29	Sturzglas mit Deckel, 29 cl, 10 cm Ø, H: 5.5 cm	6	1	2.60	2.34 2.08
178 16 37	Sturzglas mit Deckel, 37 cl, H: 6.9 cm, 10 cm Ø	6	1	2.70	2.43 2.16



Weck Schmuckgläser mit Deckel

		Stück	1	36	72
				10 %	20 %
178 15 22	Mini-Schmuckglas mit Deckel , 22 cl, H: 6.6 cm, 6 cm Ø,	12	1	2.40	2.16 1.92
178 15 56	Midi-Schmuckglas mit Deckel, 56 cl, H: 8.8 cm, 8 cm Ø	6	1	3.20	2.88 2.56



Weck Tulpengläser mit Deckel

		Stück	1	36	72
				10 %	20 %
178 14 10	Tulpenglas mit Deckel, 106.2 cl, H: 14.7 cm, 10 cm Ø	6	1	3.10	2.79 2.48
178 14 58	Tulpenglas mit Deckel, 58 cl, H: 14.7 cm, 10 cm Ø	6	1	2.60	2.34 2.08



Weck Einkochringe

		Stück	1	36	72
				10 %	20 %
178 06 50	Einkochringe, 6 cm Ø	1	10	1.50	1.12
178 06 52	Einkochringe, 8 cm Ø	1	10	1.80	1.44
178 06 53	Einkochringe, 10 cm Ø	1	10	1.80	1.44



Weck Einweck-Klammern

		Stück	1	36	72
				10 %	20 %
178 06 51	Einweck-Klammern	1	12	3.50	2.80



Naturschieferplatte

Mit 2 Vertiefungen 6 cm Ø, für Weckgläser 178 06 22

Nicht spülmaschinengeeignet

		Stück	1	12	30
				10 %	20 %
252 27 15	15 x 8 cm	1	1	5.50	4.95 4.40





Lock-eat Food Jar

		Stück	1	48	96
178 32 01	1.25 dl, H: 5.9 cm, 8.4 cm Ø	24	1	2.20	1.98
178 32 05	5 dl, H: 8.8 cm, 12 cm Ø	12	1	3.40	3.06
					20 %



Weck Mini-Einmachglas ohne Deckel

		Stück	1	36	72
178 06 03	Mini-Einmachglas ohne Deckel, 3.5 cl, H: 3.5 cm, H: 5 cm	12	1	1.10	0.99
					20 %



Mini Tumbler Bistro

stapelbar

		Stück	1		
160 47 09	95 ml, H: 7 cm, 6 cm Ø	12	1	2.90	2.32
160 47 20	200 ml, H: 8.5 cm, 7.6 cm Ø	12	1	3.70	2.96
					20 %



Tumbler Bistro

stapelbar

		Stück	1		
160 47 20	200 ml, H: 8.5 cm, 7.6 cm Ø	12	1	3.70	2.96
					20 %



Bowl Bistro

stapelbar

		Stück	1		
140 23 13	415 ml, H: 4.7 cm, 13.4 cm Ø	12	1	3.70	2.96
140 23 14	605 ml, H: 6.2 cm, 14 cm Ø	12	1	4.90	3.92
					20 %



Glasteller Bistro

stapelbar

		Stück	1		
140 22 22	22 cm Ø, H: 2 cm	12	1	4.90	3.92
					20 %



Fingerfood-Löffel

Melamin

		Stück	1		
132 25 00	weiss, 11 x 4.5 cm	1	1	1.80	1.44
132 25 99	schwarz, 11 x 4.5 cm	1	1	1.80	1.44
					20 %



Fingerfood-Löffel

Melamin

		Stück	1		
132 26 00	weiss, 13 x 4.5 cm	1	1	2.00	1.60
132 26 99	schwarz, 13 x 4.5 cm	1	1	2.00	1.60
					20 %

Buffet

Premio Apéro-Löffel

Dieser speziell für die Präsentation an Buffets entwickelte Apéro-Löffel unterscheidet sich von den herkömmlichen Produkten auf dem Markt. Durch den abgerundeten Essteil lassen sich die Häppchen angenehm einnehmen. Es ist der erste Apérolöffel mit einer mundgerechten Form. Design brunelli



	Stück	1	5	10
132 07 14 14 x 4.5 cm	24	1	2.50	1.50

China-Löffel Porzellan

	Stück	1	5	10
132 05 14 13.8 x 5 cm	12	1	3.30	2.64



Besteck Tapas

Chromstahl 18/0

	Stück	1	5	10
151 98 10 Picklöffel, 11.7 cm	12	1	1.20	0.96
151 98 11 Mini-Gabel, 12 cm	12	1	1.50	1.20
151 90 41 Espressolöffel Hit, 11.7 cm	24	1		0.39



Happy Hour

	Stück	1	5	10
151 98 03 10.6 cm, Gabel Happy Hour	12	1	4.50	4.05
151 98 01 12.5 cm, Partylöffel, schwere Qualität	12	1	6.20	5.58



Besteck Tapas Gaböffel

CNS 18/10

	Stück	1	5	10
151 98 15 Gaböffel, 11.7 cm	12	1	1.90	1.52



Party-Clips "Welcome"

Für Apéros und Stehpartys. Der Party-Clip hält rutschsicher an jedem Tellerrand

	Stück	1	5	10
280 16 00 Kunststoff, weiss	1	100	99.00	89.10



Werbedruck auf Anfrage möglich

Bambus-Picker / Spiesse Satay

	Stück	1	6	12
330 26 09 Bambus-Picker Schlaufe, 9 cm	1	2000 1000 =	79.00 39.50	71.10 35.55
330 27 12 Spiess Satay, 12 cm	1	2000 1000 =	69.00 34.50	62.10 31.05





Chafing Dish Anis, GN 1/1

CNS matt, inklusive Einsatz GN 1/1 H: 6.5 cm, mit Deckel und 2 Brenner

		Stück			1
250 67 00	62 x 36 cm, H: 31 cm	1	1	140.00	84.00
					40 %



Chafing Dish Hit

CNS poliert, inklusive Einsatz, mit Deckel und Brenner

		Stück			1
250 66 33	34 cm Ø, H: 25 cm, 4 l	1	1	92.00	73.60
					20 %



Chafing Dish Luzern, GN 1/1

CNS 18/10, inklusive Einsatz GN 1/1 H: 6.5 cm, mit Deckel und 2 Brenner

		Stück			1
251 20 00	69 x 50 cm, H: 41 cm	1	1	315.00	220.50
					30 %

		Stück			1
251 30 52	Elektro-Heizelement mit Regler 230 V, 800 W, 20 x 25 cm	1	1	265.00	212.00
					20 %

**TOP
Qualität**



Rolltop-Chafing Dish Luzern, GN 1/1

CNS 18/10, inklusive Einsatz GN 1/1 H: 6.5 cm und 2 Brenner

		Stück			1
251 30 00	64 x 35 cm, H: 39 cm	1	1	390.00	312.00
					20 %

		Stück			1
251 30 52	Elektro-Heizelement mit Regler 230 V, 800 W, 20 x 25 cm	1	1	265.00	212.00
					20 %



Löffelablage "Piccolino" GN 1/9

ohne GN-Behälter

		Stück			1
251 30 50	Löffelablage ohne GN-Behälter	1	1		30.00

		Stück			1
425 00 10	GN: 1/9, 176 x 108 mm, H: 100 mm	1	1	8.80	7.92
					10 %
					20 %



Rolltop-Chafing Dish Star

CNS 18/10, mit Rolltopdeckel, auf 90° und 180° klappbar, schwere Qualität, inklusive Einsatz und 2 Brenner

		Stück			1
250 96 00	45 cm Ø, H: 45 cm	1	1	325.00	260.00
					20 %



Wärme Kies

Für Chafing Dishes, feine Körnung, hohe Wärmespeicherung, kein Verkleben

Ideal zum Warmhalten von Eiern

		Stück			1
250 70 07	7 kg	1	1		28.00

Buffet

Rolltop-Chafing Dish Royal, GN 1/1, stapelbar

Edelstahl poliert, Rolltop-Deckel klappbar auf 90° und 180°, inklusive Einsatz GN 1/1, H: 6.5 cm, Wasserbecken und 2 Brenner

		Stück		1
250 97 00	67 x 47 cm, H: 45 cm	1	1	374.00 299.20 20 %
251 30 52	Elektro-Heizelement mit Regler 230 V, 800 W, 20 x 25 cm	1	1	265.00 212.00



Rolltop-Chafing Dish Globe

CNS 18/10
geräuschloses Öffnen des Deckels dank eingebauter Deckelbremse, Kondenswasserrückführung, für Induktionsplatten geeignet
Bestehend aus Gestell, Wasserbecken, 1 GN 1/1 Behälter 65 mm tief, Löffelablage, 2 Brennpastenbrenner, Metallrahmen für Induktionsplatte

		Stück		1
252 34 00	Chafing Dish, 66.5 x 44 cm, H: 34 cm	1	1	905.00 724.00 20 %



Elektro-Heizelement

Für GN 1/1 Chafing Dish
Mit einstellbarem Leistungsregler, für mehrheitlich geöffneten Chafing Dish

		Stück		1
251 30 52	230 V, 800 W	1	1	265.00 212.00 20 %



Chafing Dish-Besteck

		Stück		1
250 78 01	CNS 18/10, ungelocht, 35 cm	1	1	7.60
250 78 02	CNS 18/10, gelocht, 35 cm	1	1	7.90



Chafing Dish-Besteck

Schwere Ausführung

		Stück		1
250 79 01	CNS 18/10, ungelocht, 36 cm	1	1	9.60
250 79 02	CNS 18/10, gelocht, 36 cm	1	1	9.90



		Stück		1
402 02 06	Schöpfkelle klein, 26 cm	1	1	25.20 20.16 20 %
402 02 03	Reis-Servierlöffel, 26 cm	1	1	25.20 20.16
402 02 05	Schöpfkelle gross, 32 cm	1	1	25.20 20.16
402 02 01	Serviergabel, 33 cm	1	1	25.20 20.16
402 02 09	Servierlöffel gelocht, 32 cm	1	1	25.20 20.16
402 02 04	Bratschaufel gelocht, 34 cm	1	1	25.20 20.16
402 02 10	Spaghetti-Löffel, 32 cm	1	1	25.20 20.16
402 02 08	Chafing-Löffel lang, 32 cm	1	1	25.20 20.16
402 02 02	Servierlöffel kurz, 26 cm	1	1	25.20 20.16
402 02 07	Spachtel kurz, 30 cm	1	1	25.20 20.16
402 02 00	Schaumlöffel, 34 cm	1	1	25.20 20.16

Schöpfbesteck Robert Welch

CNS 18/10. Kann dank dem Hacken aufgehängt werden und verhindert das Abgleiten in die Schüssel, somit bleibt das Buffet und das Schöpfbesteck immer sauber



40%



Chafing Dish-Heizung Automatic

Edelstahl/Kunststoff-Gehäuse, Gussheizplatte stufenlos regelbar

		Stück	1	6	12
250 77 01*	14 cm Ø, H: 9 - 11 cm, 230 V, 500 W	1	1	155.00	93.00
					40 %

ab
23.70



Brennpaste Blue Flame

by Gastroimpuls

Sicher - bewährt - preisgünstig!

Die seit vielen Jahren bewährte Sicherheits-Brennpaste für alle Brennpasten-Brenner. Fast keine Brennrückstände, lässt sich im Wasserbad leicht reinigen
Einfach und sicher - sehr hoher Energie-Wert - leichtes Nachfüllen der Brenner mit der Pumpe - Brenndauer pro Füllung à 100 g: 1 1/4 - 2 Stunden

		Stück	1	6	12
242 00 00	Bidon à 4 kg	1	1	31.60	28.44
					10 %
242 00 50	Dispenserpumpe zu Blue Flame-Brennpaste	1	1		21.30
					25 %

Portionen Brennpaste



		Stück	1	6	12
242 01 36	Portionen à 80g	1	36	42.80	36.38
			1=	1.19	1.01
					0.83
242 02 00	Dose à 200g	1	72	139.00	118.15
			1=	1.93	1.64
					1.35



Brennpasten-Brenner

		Stück	1	6	12
250 75 00	Mit langem Stiel	1	1		21.00
					20 %
250 76 00	Für Dosen	1	1	11.00	8.80



Gas Nachfülldosen Kisag

		Stück	1	60	120
242 10 00	400 ml	12	1		5.50
242 10 60	600 ml	15	1		6.90



Brennersystem Hot & Safe

Sicher - heisser - sauber! Hot & Safe, das Sicherheitsbrenn-System für Chafing Dish, Fondue-Rechaud etc.

- Grosse Sicherheit, da Brennflüssigkeit nicht auslaufen kann
- Schnelle und hohe Hitzentwicklung
- Kaum Russablagerung, somit weniger Reinigungsaufwand
- Minimalste Geruchsentwicklung
- Brenndauer pro Füllung à 200 ml: 2 - 2 1/2 Stunden

		Stück	1	60	120
242 06 12	Hot & Safe 1 l	12	1	9.00	8.10
					20 %
242 06 51	Fondue-Brenner für 1 dl	1	1	14.90	13.41
242 06 52	Profi-Brenner für 2 dl	1	1	19.90	17.91
					20 %

Buffet

Chafing Dish Cool + Hot, GN 1/1

Ein Gerät - zwei Funktionen: wahlweise kalt oder heiss!

Temperaturbereich: -5° C bis + 75° C

Ideal zur platzsparenden Präsentation von warmen oder kalten Speisen/kalten Getränken z. B. für Buffet, Catering oder Party-Service.

Gehäuse Stahlblech, lackiert, Untergestell Edelstahl, Einsatz: 1/1 GN, 65 mm tief, Kühlmittel: R134a

Inklusive:

1 GN-Behälter 1/1 65 mm tief, Edelstahl, 1 abnehmbarer Rolltop-Deckel, Plexiglas



		Stück		1	10 %
251 38 00	61 x 36 cm, H: 45 cm, 700 W, 230 V, 15.3 kg	1	1	685.00	616.50

Chafing Dish Induktion Premium

CNS 18/8

1 Gestell + 1 Wasserbecken mit Sandwichboden + 1 Wasserbeckenrahmen + 1 Deckel mit hydraulischem Gelenk + 1 GN1/1 Behälter 65 mm tief, hitzebeständige Griffe, hochwertige Verarbeitung. Ausschliesslich für Induktionskochfelder

		Stück		1	20 %
250 98 00	Chafing Dish, 66 x 48 cm, H: 33 cm	1	1	1450.00	1160.00
250 98 01	Chafing Dish ohne Gestell, 66 x 48 cm, H: 33 cm	1	1	1120.00	896.00
430 94 00	Induktionsplatte rund, 20 cm Ø, mit Regler	1	1	248.00	198.40



Chafing Dish Induktion rund Premium

CNS 18/8

1 Gestell + 1 Wasserbecken mit Sandwichboden + 1 Wasserbeckenrahmen + 1 Deckel mit hydraulischem Gelenk + 1 runder Speisenbehälter, hitzebeständiger Griff, hochwertige Verarbeitung. Ausschliesslich für Induktionskochfelder

		Stück		1	20 %
250 99 00	Chafing Dish, 44 x 54 cm, H: 33 cm	1	1	1250.00	1000.00
250 99 01	Chafing Dish ohne Gestell, 44 x 54 cm, H: 33 cm	1	1	990.00	792.00
430 94 00	Induktionsplatte rund, 20 cm Ø, mit Regler	1	1	248.00	198.40



Chafing Dish Induktion rund

CNS 18/10

Design Chafing Dish mit Bügelgriff, passend für Einsätze bis 10 cm Tiefe, induktionsgeeignet, Glasdeckel mit Bremse abnehmbar, alternativ mit Elektroheizung und Brennstoff beheizbar. Höhe Chafing Dish inkl. Gestell: 37 cm

		Stück		1	10 %
251 36 00	Chafing Dish, 39 cm Ø, H: 19 cm	1	1	986.00	887.40
251 36 01	Buffetgestell, 46 cm Ø, H: 24 cm	1	1	734.00	660.60
251 37 51	Elektroheizung zu Chafing Dish, 25 x 20 cm, 230 V, 700 W	1	1	383.00	344.70
251 36 50	Porzellaneinsatz, 2-teilig, rund, 30 cm Ø	1	1	168.00	151.20
251 36 51	Porzellaneinsatz, einteilig, rund, 30 cm Ø	1	1	114.00	102.60



Chafing Dish Induktion GN 2/3

CNS 18/10

Design Chafing Dish mit Bügelgriff, passend für Einsätze bis 10 cm Tiefe, induktionsgeeignet, Glasdeckel mit Bremse abnehmbar, alternativ mit Elektroheizung und Brennstoff beheizbar. Höhe Chafing Dish inkl. Gestell: 37 cm

		Stück		1	10 %
251 37 00	Chafing Dish, 37 x 45 cm, H: 19 cm	1	1	986.00	887.40
251 37 01	Buffetgestell, 44 x 40 cm, H: 24 cm	1	1	852.00	766.80
251 37 51	Elektroheizung zu Chafing Dish, 25 x 20 cm, 230 V, 700 W	1	1	383.00	344.70
251 37 52	Porzellaneinsatz GN 1/3, H: 65 mm	1	1	68.00	61.20
251 37 53	Porzellaneinsatz GN 2/3, H: 65 mm	1	1	170.00	153.00



170.40



Suppentöpfe

Herausnehmbarer Einsatz aus Edelstahl, elektrisch, mit Wasserbad, Schöpflöffel und integrierter Tragering für den Innenbehälter, Deckel mit hitzeisolierendem Griff, Temperaturregelung 80°C (± 10°C), 450-550 W, 230 V

		Stück		1
260 57 85	10 l, braun, 38 cm Ø, H: 36.5 cm, 230 V, 450-550 W	1	1	213.00 170.40 20 %
260 57 99	10 l, schwarz, 38 cm Ø, H: 36.5 cm, 230 V, 450-550 W	1	1	213.00 170.40

Suppentöpfe

Mit Klappdeckel, herausnehmbarem Behälter aus CNS 18/10, stufenloser Thermostat



		Stück		1
260 51 10	10 l, Metall schwarz, 33 cm Ø, H: 36 cm, 230 V, 400 W, 4.75 kg	1	1	142.00 99.40 30 %
260 52 08	8 l, CNS, 34 cm Ø, H: 36 cm, 230 V, 435 W	1	1	239.00 167.30

Suppentopf Globe

CNS, inkl. Gestell und herausnehmbarem Behälter, mit einhängbarem Ablagetablett, der Sandwichboden sorgt für optimale Wärmeverteilung, hitzeisolierende Griffe, für alle Herdarten geeignet, inkl. Brennpastenbehälter



		Stück		1
260 54 10	10 l, 48 cm Ø, H: 45 cm	1	1	750.00 600.00 20 %
430 94 00	Induktionsplatte rund, 20 cm Ø, mit Regler	1	1	248.00 198.40

Suppen-Schöpfer



		Stück		1
401 09 06	7 cm Ø, 28 cm, 0.6 dl	1	1	18.00 14.40 20 %
401 09 10	9 cm Ø, 31 cm, 1.0 dl	1	1	19.00 15.20
154 90 50	Suppenschöpfer, 26.5 cm, 1 dl	1	1	20.90 16.72

Elektro-Wärmeplatte

Für GN 1/1 und GN 2/1, Gehäuse Aluminium, Oberfläche Glas, Ein/Aus-Schalter, Oberflächentemperatur max. 95° C, stufenlose Temperaturregelung von 30° - 95° C, mit Kontrolllampe



		Stück		1
250 51 11	für GN 1/1, 57 x 30.5, H: 4 cm, 150 W, 1 NAC 230 V, 3.45 kg	1	1	169.00
250 51 21	für GN 2/1, 66.6 x 55, H: 4 cm, 300 W, 1 NAC 230 V, 6.1 kg	1	1	230.00

Buffet

Glühweinkocher

Für Glühwein, Tee, Kaffee, Suppen etc., zum Kochen, Warmhalten und Einkochen. Temperatur von 30 - 100° C, stufenlos einstellbar, mit Trockenlaufsicherung, Innenbehälter aus emailliertem Stahl, säure- und laugenfest

		Stück	1
260 53 30	30 l, CNS, 35 cm Ø, 230 V, 1800 W	1	1 398.00 278.60 30 %



278.60

Tassenwärmer mit Ablage

Edelstahl Tassenwärmer für ca. 72 Tassen

- Tassentemperatur bis ca. 60° C
- Ablagefläche für Unterteller, Tassen etc.: 25 x 25 cm
- Abmessung: 32 x 36 cm, H: 54.5 cm

		Stück	1
250 59 00	140 W, 1 NAC 230 V, 11.6 kg	1	1 535.00



Tellerwärmer

Tischgerät (30 - 40 Teller), zum Aufstellen auf einem Arbeitstisch oder direkt beim Buffet. Edelstahl, mit festem Zwischenboden, 1 Drehglastür, platzsparend nach innen laufend, Thermostat einstellbar von 30 - 80°C, Tellergrößen bis 32 cm Ø. (Innen Ø 33 cm, H: 44 cm), (Aussen Ø 46 cm, H: 57.5 cm)

		Stück	1
250 58 00	für 30 - 40 Teller, 600 W, 1 NAC 230 V, 21.6 kg	1	1 809.00



Wärmeschränke

Aus Edelstahl, rostfrei, allseitig wärmeisolierte Wände, Thermostat einstellbar von 0 - 85°C, Tellergrößen bis 35 cm Ø. Bestückt mit 1 Tablar

		Stück	1
250 52 01	Mini, 40 x 46 cm, H: 57 cm, für: 25 - 30 Teller, 400 W, 1 NAC 230 V, 20 kg	1	1 425.00
250 53 01	Midi, 40 x 46 cm, H: 87 cm, für: 55 - 60 Teller, 750 W, 1 NAC 230 V, 26 kg	1	1 519.00
250 54 01	Maxi, 80 x 46 cm, H: 87 cm, für: 110 - 120 Teller, 1500 W, 1 NAC 230 V, 43 kg	1	1 895.00



ab 425.-

Tellerspender ECO beheizbar

Der neue ECO Tellerspender bringt viele Vorteile: weniger Verbrauch bei gleicher Leistung, mehr Kapazität durch kluge Konstruktion und grössere Flexibilität für jede Grösse! Herausnehmbarer Stapelinsatz, 4 Lenkrollen, davon 2 mit Bremsen

		Stück	1
431 97 00	ca. 80 Teller 18-33 cm Ø, 68 x 52 cm, H: 90 cm, 230 V, 0.9 kW, 44 kg	1	1 2090.00 1567.50 25 %
431 97 01	ca. 160 Teller 18-33 cm Ø, 107.6 x 52 cm, H: 90 cm, 230 V, 0.9 kW, 69 kg	1	1 2690.00 2017.50





GN-Schalen Figgjo Porzellan

Mit Unterglasur

		Stück	1	12	30
				10 %	20 %
137 09 81	GN: 1/6, 176 x 162 mm, H: 55 mm	1	31.70	28.53	25.36
137 09 82	GN: 1/6, 176 x 162 mm, H: 100 mm	1	44.00	39.60	35.20
137 09 72	GN: 1/3, 325 x 176 mm, H: 60 mm	1	49.60	44.64	39.68
137 09 71	GN: 1/2, 325 x 265 mm, H: 30 mm	1	55.20	49.68	44.16
137 09 73	GN: 1/2, 325 x 265 mm, H: 60 mm	1	58.10	52.29	46.48
137 09 77	GN: 1/2, 325 x 265 mm, H: 100 mm	1	87.20	78.48	69.76
137 09 78	GN: 2/4, 530 x 162 mm, H: 40 mm	1	80.30	72.27	64.24
137 09 75	GN: 1/1, 530 x 325 mm, H: 40 mm	1	122.30	110.07	97.84
137 09 74	GN: 1/1, 530 x 325 mm, H: 60 mm	1	131.40	118.26	105.12



GN-Platten Figgjo Porzellan

Mit Unterglasur

		Stück	1	12	30
				10 %	20 %
137 09 21	GN: 1/32, 65 x 65 mm, H: 14 mm	6	9.80	8.82	7.84
137 09 27	GN: 1/16, 122 x 75 mm, H: 30 mm	3	15.70	14.13	12.56
137 09 22	GN: 1/16, 122 x 75 mm, H: 15 mm	6	12.00	10.80	9.60
137 09 23	GN: 1/8, 150 x 120 mm, H: 15 mm	6	16.60	14.94	13.28
137 09 24	GN: 1/4, 265 x 162 mm, H: 18 mm	6	23.50	21.15	18.80
137 09 12	GN: 1/3, 325 x 176 mm, H: 19 mm	6	32.80	29.52	26.24
137 09 13	GN: 1/2, 325 x 265 mm, H: 19 mm	3	50.80	45.72	40.64
137 09 28	GN: 2/4, 530 x 162 mm, H: 19 mm	2	68.40	61.56	54.72
137 09 14	GN: 2/3, 325 x 354 mm, H: 19 mm	1	71.30	64.17	57.04
137 09 29	GN: 1/1, 530 x 325 mm, H: 19 mm	2	114.80	103.32	91.84



Platten rechteckig Form - Figgjo Porzellan

		Stück	1	12	30
				10 %	20 %
137 07 70*	32 x 5.5 cm	1	36.00	32.40	28.80
137 07 71	32 x 11 cm	1	42.30	38.07	33.84
137 07 72	32 x 17 cm	1	46.90	42.21	37.52
137 07 73	32 x 27 cm	1	56.40	50.76	45.12
137 07 74*	46 x 7 cm	1	59.90	53.91	47.92
137 07 75	46 x 10 cm	1	78.20	70.38	62.56
137 07 76	51 x 15 cm	1	105.50	94.95	84.40
137 07 77	58 x 20 cm	1	152.50	137.25	122.00
137 07 78	59.5 x 33 cm	1	198.00	178.20	158.40



Deckel zu Platten Form Figgjo

		Stück	1	12	30
				10 %	20 %
137 09 94	32 x 17 cm, H: 7 cm	6	44.20	39.78	35.36
137 09 95	32 x 27 cm, H: 7 cm	6	44.20	39.78	35.36
137 09 96	46 x 10 cm, H: 7 cm	6	55.70	50.13	44.56
137 09 97	51 x 15 cm, H: 7 cm	6	63.20	56.88	50.56
137 09 98	58 x 20 cm, H: 7 cm	6	71.80	64.62	57.44
137 09 99	59.5 x 33 cm, H: 7 cm	6	102.10	91.89	81.68

Buffet

GN-Schalen Porzellan ECO

		Stück		1	
				32.40	22.68
				34.60	24.22
				42.10	29.47
				51.80	36.26
				38.90	27.23
				59.40	41.58
				51.80	36.26
				75.60	52.92
				84.20	58.94
				97.20	68.04



ab
22.68

Blanco Buffet Line Emaille

Für eine besonders ansprechende Speisenpräsentation

- hochwertige Emaille-Beschichtung mit seidmattter Oberfläche
- einfache Reinigung
- Temperaturbereich bis +300°C
- für Induktions-Warmhalteplatten geeignet

GN-Behälter Blanco weiss

emailliert

GN-Behälter Blanco schwarz

emailliert

		Stück		1	
				31.00	24.80
				38.50	30.80
				42.50	34.00
				43.50	34.80
				62.00	49.60
				69.50	55.60
				91.00	72.80
				35.50	28.40
				39.50	31.60
				41.50	33.20
				46.50	37.20
				43.50	34.80
				50.50	40.40
				56.00	44.80
				63.00	50.40

		Stück		1	
				31.00	24.80
				38.50	30.80
				42.50	34.00
				43.50	34.80
				62.00	49.60
				69.50	55.60
				91.00	72.80
				35.50	28.40
				39.50	31.60
				41.50	33.20
				46.50	37.20
				43.50	34.80
				50.50	40.40
				56.00	44.80
				63.00	50.40

Andere Grössen auf Anfrage

Andere Grössen auf Anfrage





Melamin

- erstklassige Porzellan-Optik
- geruchs- und geschmacksneutral
- glänzende und harte Oberfläche, robust und stabil
- temperaturbeständig ca. -30°C - +70°C
- lebensmittelecht, hygienisch
- extrem bruchsicher, daher keine gefährlichen Scherben
- nicht Backofen und Mikrowellen geeignet!
- spülmaschinengeeignet



Melamin GN-Behälter Style

Temperaturbeständig -20°C bis 70°C, spülmaschinengeeignet

		Stück	1	12	30
				49.30	30 %
270 37 16	GN: 1/6, 17.5 x 16.2 cm, H: 6.5 cm	1	1	13.51	
270 37 14	GN: 1/4, 26.5 x 16.2 cm, H: 6.5 cm	1	1	28.10	19.67
270 37 13	GN: 1/3, 32.5 x 17.5 cm, H: 6.5 cm	1	1	29.20	20.44
270 37 12	GN: 1/2, 32.5 x 26.5 cm, H: 6.5 cm	1	1	34.60	24.22
270 37 24	GN: 2/4, 53 x 16.2 cm, H: 6.5 cm	1	1	52.90	37.03
270 37 11	GN: 1/1, 53 x 32.5 cm, H: 6.5 cm	1	1	68.00	47.60



Melamin Buffetausstellplatten Style

Temperaturbeständig -20°C bis 70°C, spülmaschinengeeignet

		Stück	1	12	30
				10 %	20 %
270 38 24	GN: 2/4, 53 x 16.5 cm, H: 3 cm	1	1	21.40	19.26
270 38 11	GN: 1/1, 53 x 32.5 cm, H: 3 cm	1	1	41.00	36.90



Melamin Buffetausstellschalen Style

Temperaturbeständig -20°C bis 70°C, spülmaschinengeeignet

		Stück	1	12	30
				10 %	20 %
270 39 25*	weiss, 25 x 15 cm, H: 7 cm	3	1	16.00	14.40
270 39 35*	weiss, 35 x 25 cm, H: 7 cm	3	1	29.80	26.82
270 39 45	weiss, 45 x 30 cm, H: 7 cm	2	1	41.00	36.90
270 39 50	weiss, 50 x 20 cm, H: 7.5 cm	3	1	34.60	31.14
270 40 25	schwarz, 25 x 15 cm, H: 7 cm	3	1	17.30	15.57
270 40 35	schwarz, 35 x 25 cm, H: 7 cm	3	1	34.60	31.14
270 40 45	schwarz, 45 x 30 cm, H: 7 cm	2	1	41.00	36.90
270 40 50	schwarz, 50 x 20 cm, H: 7.5 cm	3	1	34.60	31.14



Melamin Buffetausstellplatten Boat Style

Temperaturbeständig -20°C bis 70°C, spülmaschinengeeignet

		Stück	1	12	30
				17.30	20 %
270 44 32	32 x 21 cm, H: 7 cm	6	1	13.84	
270 44 47	47 x 21 cm, H: 4 cm	3	1	27.00	21.60



Melamin Buffetausstellplatten Style

Temperaturbeständig -20°C bis 70°C, spülmaschinengeeignet

		Stück	1	12	30
				10 %	20 %
270 41 36	36 x 20.5 cm, H: 4 cm	3	1	23.80	21.42
270 41 50	49.5 x 27.5 cm, H: 5 cm	3	1	42.10	37.89

Buffet

Melamin GN-Behälter

Temperaturbeständig -30°C bis 70°C, spülmaschinengeeignet

		Stück		1	
				20 %	
270 32 16	GN: 1/6, 17,5 x 16,2 cm, H: 6,5 cm	3	1	43,90	11.12
270 33 14	GN: 1/6, 17,5 x 16,2 cm, H: 10 cm	6	1	49,00	15.20
270 32 14	GN: 1/4, 26,5 x 16,2 cm, H: 6,5 cm	3	1	21,80	17.44
270 33 15	GN: 1/4, 26,5 x 16,2 cm, H: 10 cm	1	1	25,00	20.00
270 32 13	GN: 1/3, 32,5 x 17,5 cm, H: 6,5 cm	3	1	48,80	15.04
270 33 13	GN: 1/3, 32,5 x 17,5 cm, H: 10 cm	4	1	28,00	22.40
270 32 12	GN: 1/2, 32,5 x 26,5 cm, H: 6,5 cm	6	1	27,50	22.00
270 33 12	GN: 1/2, 32,5 x 26,5 cm, H: 10 cm	3	1	37,00	29.60
270 32 23	GN: 2/3, 35 x 32,5 cm, H: 6,5 cm	3	1	51,00	40.80
270 32 24	GN: 2/4, 53 x 16,2 cm, H: 6,5 cm	3	1	37,00	29.60
270 32 11	GN: 1/1, 53 x 32,5 cm, H: 6,5 cm	5	1	45,30	36.24
270 33 11	GN: 1/1, 53 x 32,5 cm, H: 10 cm	2	1	64,00	51.20



TOP

Melamin Buffetausstellplatten

Temperaturbeständig -30°C bis 70°C, spülmaschinengeeignet

		Stück		1	
				20 %	
270 31 14	weiss, GN: 1/4, 26,5 x 16,2 cm, H: 3 cm	6	1	47,00	13.60
270 31 13	weiss, GN: 1/3, 32,5 x 17,5 cm, H: 3 cm	6	1	22,00	17.60
270 31 12	weiss, GN: 1/2, 32,5 x 26,5 cm, H: 3 cm	6	1	30,00	24.00
270 31 24	weiss, GN: 2/4, 53 x 16,2 cm, H: 3 cm	6	1	33,00	26.40
270 30 53	weiss, GN: 1/1, 53 x 32,5 cm, H: 3 cm	4	1	57,00	45.60
270 31 30	weiss, 30 x 21 cm, H: 3 cm	4	1	22,00	17.60
270 31 36	weiss, 35,5 x 18 cm, H: 3 cm	6	1	49,00	15.20
270 31 53	weiss, 53 x 18 cm, H: 3 cm	3	1	37,00	29.60
270 29 14	schwarz, GN: 1/4, 26,5 x 16,2 cm, H: 3 cm	6	1	47,00	13.60
270 29 13	schwarz, GN: 1/3, 32,5 x 17,5 cm, H: 3 cm	6	1	22,00	17.60
270 29 12	schwarz, GN: 1/2, 32,5 x 26,5 cm, H: 3 cm	6	1	30,00	24.00
270 29 24	schwarz, GN: 2/4, 53 x 16,2 cm, H: 3 cm	6	1	33,00	26.40
270 29 53	schwarz, GN: 1/1, 53 x 32,5 cm, H: 3 cm	3	1	57,00	45.60



Melamin Buffetschalen

Temperaturbeständig -30°C bis 70°C, spülmaschinengeeignet

		Stück		1	
				20 %	
270 30 09	weiss, 9 x 9 cm, H: 4 cm	6	1	5,40	4.32
270 30 13	weiss, 12,5 x 12,5 cm, H: 6 cm	5	1	8,80	6.32
270 30 19	weiss, 19 x 19 cm, H: 9 cm	5	1	29,00	23.20
270 30 25	weiss, 25 x 25 cm, H: 12 cm	3	1	47,00	37.60
270 49 09	schwarz, 9 x 9 cm, H: 4 cm	6	1	5,60	4.48
270 49 13	schwarz, 12,5 x 12,5 cm, H: 6 cm	1	1	8,90	7.12
270 49 19	schwarz, 19 x 19 cm, H: 9 cm	1	1	30,00	24.00
270 49 25	schwarz, 25 x 25 cm, H: 12 cm	1	1	48,00	38.40



Melamin Schalen rund

Temperaturbeständig -30°C bis 70°C, spülmaschinengeeignet

		Stück		1	
				20 %	
270 31 14	grau/crème, Ø 24 cm, H: 9,5 cm	1	1	29,00	23.20
270 31 13	grau/crème, Ø 26,5 cm, H: 11 cm	1	1	34,00	27.20
270 31 12	grau/crème, Ø 33 cm, H: 12 cm	1	1	47,00	37.60



NEW



Melamin Buffetplatten Wood

Die Melaminplatten Wood (Eiche-Holzoptik) haben eine leicht wellige Oberfläche und wirken optisch wie aus Holz gefertigt, spülmaschineneeignet
Temperaturbeständig -30°C bis 70°C



		Stück	1	6	12	
270 58 14	GN: 1/4, 26.5 x 16.2 cm, H: 1.5 cm	1	1	19.00	17.10	15.20
270 58 24	GN: 2/4, 53 x 16.2 cm, H: 1.5 cm	1	1	38.00	34.20	30.40
270 58 13	GN: 1/3, 32.5 x 17.5 cm, H: 1.5 cm	1	1	24.00	21.60	19.20
270 58 12	GN: 1/2, 32.5 x 26.5 cm, H: 1.5 cm	1	1	32.90	29.61	26.32
270 58 11	GN: 1/1, 53 x 32.5 cm, H: 1.5 cm	1	1	64.00	57.60	51.20

Melamin Buffetplatte Wood

Die Melaminplatten Wood (Eiche-Holzoptik) haben eine leicht wellige Oberfläche und wirken optisch wie aus Holz gefertigt, spülmaschineneeignet.
Temperaturbeständig -30°C bis 70°C



		Stück	1	6	12	
270 58 35	35 Ø, H: 3 cm	1	1	46.00	41.40	36.80

Melamin Buffetplatten Wood

Holzoptik Eiche dunkel, spülmaschineneeignet
Temperaturbeständig -30°C bis 70°C



		Stück	1	6	12	
270 59 14	GN: 1/4, 26.5 x 16.2 cm, H: 1.5 cm	1	1	27.00	24.30	21.60
270 59 24	GN: 2/4, 53 x 16.2 cm, H: 1.5 cm	1	1	47.00	42.30	37.60
270 59 13	GN: 1/3, 32.5 x 17.5 cm, H: 1.5 cm	1	1	35.00	31.50	28.00
270 59 12	GN: 1/2, 32.5 x 26.5 cm, H: 1.5 cm	1	1	47.00	42.30	37.60

Melamin Buffetplatte

Spülmaschineneeignet, Temperaturbeständig -30°C bis 70°C



		Stück	1	6	12
252 59 38	38 cm Ø, H: 2.5 cm	1	1	35.00	28.00
251 88 50	Rolltophaube 38 cm Ø	1	1	42.00	33.60

Servierplatte Wood

Eiche dunkel



		Stück	1	6	12
252 58 38	38 cm Ø, H: 2 cm	1	1	87.00	69.60
251 88 50	Rolltophaube 38 cm Ø	1	1	42.00	33.60

Buffet



Modula - das multifunktionale Buffetsystem

Buffetsystem „Modula“ ist ein multifunktionales Buffetsystem, das sich in Höhe und Breite allen Platzanforderungen anpasst. Die stapelbaren Holzboxen lassen sich rutschfest stapeln und mit flachen GN Platten verbinden und einzeln nutzen. Individuell können Buffetlandschaften gebaut werden.

Buffetsystem Modula GN 1/4

aus Akazienholz, als Buffet-Box sowie für GN 1/4 Platten einsetzbar

	Stück	1	3	6
261 77 14 29 x 18.5 cm, H: 10.5 cm	1	1	24.00	21.60 19.20
				10 % 20 %



Buffetsystem Modula GN 2/4

aus Akazienholz, als Buffet-Box sowie für GN 2/4 Platten einsetzbar

	Stück	1	3	6
261 77 24 55.5 x 18.5 cm, H: 10.5 cm	1	1	37.00	33.30 29.60
				10 % 20 %



Buffetsystem Modula GN 1/2

aus Akazienholz, als Buffet-Box sowie für GN 1/2 Platten einsetzbar

	Stück	1	3	6
261 77 12 35 x 29 cm, H: 10.5 cm	1	1	28.00	25.20 22.40
				10 % 20 %



Buffetsystem Modula GN 1/1

aus Akazienholz, als Buffet-Box sowie für GN 1/1 Platten einsetzbar

	Stück	1	3	6
261 77 11 55.5 x 35 cm, H: 10.5 cm	1	1	45.00	40.50 36.00
				10 % 20 %



Melamin Buffetplatten Marmor-Look

glatte und hochglänzende Oberfläche, mit Antirutsch-Füsschen, spülmaschinengeeignet

Temperaturbeständig -30°C bis 70°C

	Stück	1	3	6
261 76 14 GN: 1/4, 26.5 x 16.2 cm, H: 1.5 cm	1	1	19.00	17.10 15.20
261 76 24 GN: 2/4, 53 x 16.2 cm, H: 1.5 cm	1	1	38.00	34.20 30.40
261 76 12 GN: 1/2, 32.5 x 26.5 cm, H: 1.5 cm	1	1	33.00	29.70 26.40
261 76 11 GN: 1/1, 53 x 32.5 cm, H: 1.5 cm	1	1	64.00	57.60 51.20
				10 % 20 %





Frames - Das Buffet mit Stil

Die neue Buffetlinie Frames zeichnet sich durch Funktionalität, Univerisalität und Stil aus

Die Buffetelemente sind multifunktional und lassen sich unterschiedlich kombinieren



Basiselement GN 1/1 Frames

mit Tablett 18/10 und Kühllakku

Wenge

		Stück	1	6	12
260 71 10	53 x 32.5 cm, H: 8.5 cm	1	1	451.00	360.80
				20 %	



Brotbretteinlage GN 1/1 Frames

Ahorn, massiv, gerillt

		Stück	1	6	12
260 71 11	53 x 32.5 cm	1	1	108.00	78.40
				20 %	



Käsebretteinlage GN 1/1 Frames

Polyethylen, schwarz

		Stück	1	6	12
260 71 12	53 x 32.5 cm	1	1	105.00	86.40
				20 %	



Metall-Tabletts

CNS 18/10

		Stück	1	6	12
282 08 12	GN: 1/2, 32.5 x 26.5 cm	1	1	30.00	27.00
282 08 11	GN: 1/1, 53 x 32.5 cm	1	1	51.00	45.90
				10 %	20 %



Modul Bowl Frames

Schüsselhalter Set GN 1/1 inkl. 5 weissen Melaminschüsseln und 5 Deckeln

Wenge

		Stück	1	6	12
260 71 13	53 x 32.5 cm	1	1	248.00	198.40
				20 %	

Service

Poly-Rattan-Körbe GN 1/3, GN 1/2 und GN 1/1

Kunststoffgeflecht, hygienisch, lebensmittelecht, leichte Reinigung, stabile Ausführung mit Edelstahlendraht im Rand, spülmaschinengeeignet

ab
12.80



		Stück	1	12	30
211 09 13	GN: 1/3, 32.5 x 17.5 cm, H: 6.5 cm	1	1	16.00	14.40 12.80
211 15 13	GN: 1/3, 32.5 x 17.5 cm, H: 10 cm	1	1	20.00	18.00 16.00
211 09 12	GN: 1/2, 32.5 x 26.5 cm, H: 6.5 cm	1	1	20.00	18.00 16.00
211 15 12	GN: 1/2, 32.5 x 26.5 cm, H: 10 cm	1	1	25.00	22.50 20.00
211 09 11	GN: 1/1, 53 x 32.5 cm, H: 6.5 cm	1	1	32.00	28.80 25.60
211 15 11	GN: 1/1, 53 x 32.5 cm, H: 10 cm	1	1	38.00	34.20 30.40

Basiselement GN 1/1 mit Rolltop Frames

Mit Tablett CNS 18/10 und Kühlakku

Wenge



		Stück	1	12	30
260 72 10	53 x 32.5 cm, H: 25.5 cm	1	1	561.00	448.80

Holz-Gestell GN 1/1 Frames

Buche massiv, Wenge

Gestell ist vielseitig einsetzbar, passt zu allen GN 1/1 Artikel



		Stück	1	12	30
260 71 14	57.5 x 27.5 cm, H: 22 cm	1	1	449.00	119.20

Bowls Box Frames

Isolierendes Basiselement, Melaminschüssel weiss mit Deckel

Box S:

Basiselement 17.4 x 17.4 cm, Höhe 6.0 cm, Schüssel 0.5 Liter, Ø 14 cm, Höhe 6.5 cm

Box L:

Basiselement 26.5 x 26.5 cm, Höhe 8.5 cm, Schüssel 2.5 Liter, Ø 23 cm, Höhe 10.5 cm



		Stück	1	12	30
260 73 10	Box S, 17.4 x 17.4 cm	1	1	121.00	96.80
260 73 11	Box L, 26.5 x 26.5 cm	1	1	218.00	174.40

Cerealien Frames

Holzständer inkl. 3 Gläser (Inhalt 2 Liter) mit luftdichtem Klappdeckel

Wenge



		Stück	1	12	30
260 75 10	Holzständer mit 3 Gläser, 43 x 17 cm, H: 13.5 cm	1	1	145.00	116.00
171 50 20	Einmachglas Fido, 2 l	6	1	5.80	5.22 4.64

Glasplatten Mirror Silver

Glasplatte in silberner Spiegeloptik, mit Antirutsch-Füsschen



		Stück	1	6	12
252 20 24	GN: 2/4, 53 x 16.2 cm	1	1	19.00	17.10 15.20
252 20 11	GN: 1/1, 53 x 32.5 cm	1	1	38.00	34.20 30.40
252 20 12	GN: 1/2, 32.5 x 26.5 cm	1	1	20.00	18.00 16.00



Bridge - der Alleskönner für Ihr Buffet!

Das Buffet-System „Bridge“ steht für Design und Funktionalität

Die perfekt aufeinander abgestimmten Komponenten unterstützen die Präsentation Ihrer Speisen und ermöglichen Ihnen den unkomplizierten Aufbau einer einzigartigen Buffet-Landschaften. Die in den Holzoberflächen Ahorn und Wenge erhältlichen Artikel sind in ihren Höhen und ihren Volumina optimal aufeinander abgestimmt und gewährleisten einen einfachen und sicheren Umgang in Ihrem Gastronomiealltag.



Kühlboxen Bridge

Set bestehend aus: 1 Holz-Gestell, 1 Behälter aus Kunststoff, 1 GN 1/1 Tablett aus Melamin, 1 Kühlakku, 1 Rolltophaube (fix montiert)

63.5 x 42.5 cm, Höhe 31 cm

		Stück		1
261 70 80	ahorn	1	1	605.00 484.00
261 70 89	wenge	1	1	605.00 484.00



Kühlschalen Bridge Little

Set bestehend aus: 1 Holz-Gestell, 1 Behälter aus Edelstahl, 1 Schale aus Melamin (14 cm Ø), 1 Kühlakku

18.5 x 18.5 cm, Höhe 10 cm

		Stück		1
261 71 80	ahorn	1	1	94.00 75.20
261 71 89	wenge	1	1	94.00 75.20



Kühlschalen Bridge Big

Set bestehend aus: 1 Holz-Gestell, 1 Behälter aus Edelstahl, 1 Schale aus Melamin (23 cm Ø), 1 Kühlakku

27.5 x 27.5 cm, Höhe 14 cm

		Stück		1
261 72 80	ahorn	1	1	185.00 148.00
261 72 89	wenge	1	1	185.00 148.00

Buffet

Deckel zu Kühlschaln Brigde

		Stück		1
				20 %
261 71 50	14 cm Ø	1	1	18.00 14.40
261 72 50	23 cm Ø	1	1	34.00 27.20



Cerealien-Spender Brigde 4.5 l

Behälter herausnehmbar, „Feierabend-Deckel“ für das aromadichte Lagern, portionieren durch einfaches Drehen

21 x 20 cm, Höhe 55.5 cm

		Stück		1
				20 %
261 73 80	ahorn	1	1	185.00 148.00
261 73 89	wenge	1	1	185.00 148.00



Saft-Dispenser Brigde 6 l

Kühlung durch 2 Kühlakkus von oben und unten Inklusiv 3 Magnetschilder: ORANGE, APPLE, GRAPEFRUIT

35.5 x 22 cm, Höhe 50 cm

		Stück		1
				20 %
261 74 80	ahorn	1	1	484.00 387.20
261 74 89	wenge	1	1	484.00 387.20



Konferenz-/Flaschenkühler Brigde

2-teiliges Set, bestehend aus: 1 Holz-Gestell, 1 Behälter aus CNS 18/8, aussen poliert, innen matt, doppelwandig für beste Isolierung

35 x 35 cm, Höhe 19 cm

		Stück		1
				20 %
261 75 80	ahorn	1	1	281.00 224.80
261 75 89	wenge	1	1	281.00 224.80



Konferenz-/Flaschenkühler Brigde

CNS 18/8, aussen poliert, innen matt

Doppelwandig für beste Isolierung

		Stück		1
				20 %
310 03 00	H: 20 cm, 31 cm Ø, 10 l	1	1	178.00 142.40



Brezel- und Wurstständer

Buchen-Holz versiegelt, bestens geeignet für die Präsentation von Brezeln, Würstchen, etc., Fuss Ø 22 cm

		Stück		1
				20 %
252 28 50	28 cm Ø, H: 50 cm	1	1	33.00 26.40





Buffet-Leiter Little

12-teiliges Set: 1 Leiter-Gestell, 4 Glasschalen 14 cm Ø - 0,5 Liter, 4 klappbare Schutzdeckel mit Beschriftungsfenster, 1 Doppelring, 2 Einzelringe, einfach und individuell zusammensetzbar

		Stück		
261 42 48	30 x 30 cm, H: 48 cm	1	1	180.00 144.00
				1 20 %



Buffet-Leiter Big

12-teiliges Set: 1 Leiter-Gestell, 4 Glasschalen 23 cm Ø - 2,5 Liter, 4 klappbare Schutzdeckel mit Beschriftungsfenster, 1 Doppelring, 2 Einzelringe, einfach und individuell zusammensetzbar

		Stück		
261 43 66	39 x 31 cm, H: 66 cm	1	1	270.00 216.00
				1 20 %



Buffet-Leiter Little GN 1/2

4-teilig: 1 Leiter-Gestell, 3 GN 1/2 Rahmen

Lieferung ohne Körbe

		Stück		
261 40 12	31.5 x 41.5 cm, H: 48 cm	1	1	142.00 113.60
				1 20 %



Buffet-Leiter Big GN 1/2

5-teilig: 1 Leiter-Gestell, 4 GN 1/2 Rahmen

Lieferung ohne Körbe

		Stück		
261 41 12	31.5 x 56 cm, H: 66 cm	1	1	226.00 180.80
				1 20 %



Buffet-Leiter Big GN 1/1

4-teilig: 1 Leiter-Gestell, 3 GN 1/1 Rahmen

Lieferung ohne GN-Schalen

		Stück		
261 41 11	52 x 59 cm, H: 66 cm	1	1	226.00 180.80
				1 20 %

Buffet

Präsentierpiano-Sandwichtreppe

Edelstahl, mit 4 Fächern

		Stück	1	12	30
252 33 56	56 x 8 cm, H: 5.5 cm	1	1	22.00	17.60



Melamin Buffetplatte

Spülmaschinengeeignet, Temperaturbeständig -30°C bis 70°C

		Stück	1	12	30
252 59 38	38 Ø, H: 2.5 cm	1	1	35.00	28.00
251 88 50	Rolltopphaube 38 cm Ø	1	1	42.00	33.60



Servierplatte Wood

Eiche dunkel

		Stück	1	12	30
252 58 38	38 Ø, H: 2 cm	1	1	87.00	69.60
251 88 50	Rolltopphaube 38 cm Ø	1	1	42.00	33.60



Poly-Rattan-Körbe GN 1/3, GN 1/2 und GN 1/1

Kunststoffgeflecht, hygienisch, lebensmittelecht, leichte Reinigung, stabile Ausführung mit Edelstahldraht im Rand, spülmaschinengeeignet

		Stück	1	12	30
211 09 13	GN: 1/3, 32.5 x 17.5 cm, H: 6.5 cm	1	1	16.00	14.40
211 15 13	GN: 1/3, 32.5 x 17.5 cm, H: 10 cm	1	1	20.00	18.00
211 09 12	GN: 1/2, 32.5 x 26.5 cm, H: 6.5 cm	1	1	20.00	18.00
211 15 12	GN: 1/2, 32.5 x 26.5 cm, H: 10 cm	1	1	25.00	22.50
211 09 11	GN: 1/1, 53 x 32.5 cm, H: 6.5 cm	1	1	32.00	28.80
211 15 11	GN: 1/1, 53 x 32.5 cm, H: 10 cm	1	1	38.00	34.20



Poly-Rattan-Körbe GN 1/3, GN 1/2 und GN 1/1

Kunststoffgeflecht, hygienisch, lebensmittelecht, leichte Reinigung, stabile Ausführung mit Edelstahldraht im Rand, spülmaschinengeeignet

		Stück	1	12	30
211 16 13	GN: 1/3, 32.5 x 17.5 cm, H: 10 cm	1	1	18.00	16.20
211 16 12	GN: 1/2, 32.5 x 26.5 cm, H: 10 cm	1	1	24.00	21.60
211 16 11	GN: 1/1, 53 x 32.5 cm, H: 10 cm	1	1	38.00	34.20



Multi Rack

Set bestehend aus: 1 Gestell Edelstahl 18/0, matt poliert inkl. Kunstschalen

		Stück	1	12	30
310 80 02	Multi Rack, 2-stufig, 3-Teile, 19 x 24 cm, H:28 cm	3	1	63.00	50.40
310 80 03	Multi Rack, 3-stufig, 4-Teile, 19 x 24 cm, H:41 cm	6	1	74.00	59.20
310 80 04	Multi Rack, 4-stufig, 5-Teile, 19 x 24 cm, H:53 cm	3	1	93.00	74.40



NEW



Fleisch-/Käseplatten gekühlt Square

mit Rolltophaube, inkl. Kühlakku

		Stück		1 20 %
261 53 00	rund, 38 x 38 cm, H: 23 cm	1	1	330.60 264.48
261 52 00	rechteckig, 50 x 30 cm, H: 20 cm	1	1	343.20 274.56



Getränkekühler Square

mit Kühlakku, 2 l Glaskrug und Deckel

		Stück		1 20 %
260 99 20	Getränkekühler, 1,5 l, 17,5 x 17,5 cm	1	1	142.20 113.76



Joghurt-/Konfitürenbehälter gekühlt Square

mit Kühlakku und Glasschale (261 58 00, 15 cm Ø/ 261 61 00, 23 cm Ø) mit Deckel

		Stück		1 20 %
261 58 00	17,5 x 17,5 cm	1	1	103.40 82.72
261 61 00	24 x 24 cm	1	1	157.30 125.84



Tortenplatten Square

CNS 18/10, mit Rolltophaube

		Stück		1 20 %
261 59 00	Tortenplatte flach, 38 cm Ø	1	1	140.00 112.00
261 60 00	Tortenplatte mit Fuss, H: 15 cm, 38 cm Ø	1	1	200.00 160.00



Square Cerealien-Spender 4 l

		Stück		1 20 %
261 63 04	4 l, 18 x 27 cm, H: 53 cm	1	1	540.00 432.00

Saft-Dispenser Square 7 l

		Stück		1 20 %
261 62 07	7 l, 23,5 x 31 cm, H: 50 cm	1	1	620.00 496.00

Buffet

hulu Besteckboxen

Für Buffets, Service-Stationen, Servierwagen, Küchen etc., für ca. 60 - 80 Bestecke, stapelbar, aus hochwertigem Kunststoff, temperaturbeständig von -30 bis +110°C
29 x 12.7 cm, H: 10.5 cm, Design brunelli

		Stück	1	30	60
				5 %	10 %
280 20 90	hellgrau	1	1	12.00	11.40 10.80
280 20 98	anthrazit	1	1	12.00	11.40 10.80
280 20 89	dunkelbraun	1	1	12.00	11.40 10.80



hulu Einsteckschilder

		Stück	1	30	60
				5 %	10 %
280 21 01	Gabel	1	1	2.60	2.47 2.34
280 21 02	Messer	1	1	2.60	2.47 2.34
280 21 03	Löffel	1	1	2.60	2.47 2.34
280 21 04	Kaffeelöffel	1	1	2.60	2.47 2.34



hulu Halter für Besteckboxen, 2-stöckig

Aus Chromnickelstahl (ohne Besteckboxen), Tiefe mit Boxen: 35 cm

		Stück	1	30	60
				5 %	10 %
280 22 02	Für 2 Boxen, 13.8 cm	1	1	155.00	
280 22 04	Für 4 Boxen, 27 cm	1	1	165.00	
280 22 06	Für 6 Boxen, 38.5 cm	1	1	174.00	
280 22 08	Für 8 Boxen, 51.5 cm	1	1	183.00	



hulu Halter für Besteckboxen, 3-stöckig

Aus Chromnickelstahl (ohne Besteckboxen), Tiefe mit Boxen: 41 cm

		Stück	1	30	60
				5 %	10 %
280 23 03	Für 3 Boxen, 13.8 cm	1	1	219.00	
280 23 06	Für 6 Boxen, 27 cm	1	1	231.00	
280 23 09	Für 9 Boxen, 39.5 cm	1	1	244.00	
280 23 12	Für 12 Boxen, 51.5 cm	1	1	256.00	



hulu Halter für Besteckboxen, 4-stöckig

Aus Chromnickelstahl (ohne Besteckboxen), Tiefe mit Boxen: 47 cm

		Stück	1	30	60
				5 %	10 %
280 24 04	Für 4 Boxen, 13.8 cm	1	1	292.00	
280 24 08	Für 8 Boxen, 27 cm	1	1	308.00	
280 24 12	Für 12 Boxen, 39.5 cm	1	1	325.00	
280 24 16	Für 16 Boxen, 51.5 cm	1	1	342.00	



hulu Wandschienen für Besteckboxen

Chromnickelstahl, beliebig viele Wandschienen neben- oder übereinander montierbar, inkl. Schrauben und Dübel

		Stück	1	30	60
				5 %	10 %
280 30 04	Für 4 Besteckboxen, 50.5 cm	1	1	25.00	
280 30 06	Für 6 Besteckboxen, 76 cm	1	1	33.50	



Besteckkasten 4-teilig GN 1/1

4 Mulden für je ca. 20 - 40 Bestecke, Polyethylen, stapelbar

		Stück	1	6	12
				5 %	10 %
280 35 00	H: 10 cm	1	1	10.00	9.50 9.00





Melamin Buffetschalen

Temperaturbeständig -30°C bis 70°C, stapelbar

		Stück	1	6	12
270 28 15	14.5 cm Ø, H: 9 cm	1	8.20	7.38 10 %	6.56 20 %
270 28 21	21 cm Ø, H: 13 cm	1	18.00	16.20 10 %	14.40 20 %
270 28 25	24.5 cm Ø, H: 15 cm	1	24.00	21.60 10 %	19.20 20 %
270 28 30	30 cm Ø, H: 19.5 cm	1	39.00	35.10 10 %	31.20 20 %



Buffetständer Tre

Zinkdruckguss hartverchromt, die Arme und der Boden sind mit Antirutschflächen ausgestattet, schwere standsichere Qualität, Fuss dient als Löffelablage, Schüssel, Teller und Tablett werden durch die Ständer auf engstem Raum zum Highlight. Die zwei Höhenvarianten sind entwickelt worden, dass nahezu jedes handelsübliche Geschirr genutzt werden kann

		Stück	1	6	12
251 94 14	15 cm Ø, H: 14 cm	1	57.00	51.30 10 %	45.60 20 %
251 94 21	15 cm Ø, H: 21 cm	1	63.00	56.70 10 %	50.40 20 %



Menage Pure

Ständer Edelstahl matt poliert, inklusive 3 Melamin-Schalen weiss, 9 cm Ø

		Stück	1	12	30
200 18 00	Menage, 14 x 14 cm, H: 16 cm	1	38.00	34.20 10 %	30.40 20 %



Melamin Buffetausstellplatte Style

Temperaturbeständig -20°C bis 70°C

		Stück	1	12	30
270 42 42	42 x 42 cm, H: 5 cm	3	48.60	43.74 10 %	38.80 20 %



Melamin Buffet Schale XXL Style

Temperaturbeständig -20°C bis 70°C

		Stück	1	1	1
270 46 60*	60 cm Ø, H: 15 cm	1	1	138.20	96.70 30 %



Melamin Buffetausstellplatte XXL Style

Temperaturbeständig -20°C bis 70°C

		Stück	1	1	1
270 47 71*	71 x 28.5 cm, H: 4.5 cm	1	1	75.60	52.90 30 %

Buffet

Naturschieferplatten

Hervorragende Kältespeicherung durch Naturschiefer, mit lebensmittelechtem Speziallack versiegelt, fett- und wasserdichte Oberfläche, um die typische Struktur des Materials hervorzuheben sind die Kanten der Platten gebrochen und nicht gesägt

Nicht spülmaschinengeeignet

		Stück		1
				20 %
252 25 30	30 x 12 cm	1	1	8.80 7.04
252 25 13	GN: 1/3, 32.5 x 17.6 cm	1	1	10.00 8.00
252 25 12	GN: 1/2, 32.5 x 26.5 cm	1	1	17.00 13.60
252 25 11	GN: 1/1, 53 x 32.5 cm	1	1	32.00 25.60



Buffet- und Tortenclochen Strasbourg

Stilvolle Glas-Cloche und Glas-Teller, komplett

		Stück		1
				20 %
140 56 11	Cloche 11 cm Ø, Teller 13 cm Ø	1	1	19.00 15.20
140 56 20	Cloche 20 cm Ø, Teller 25 cm Ø	1	1	43.00 34.40
140 56 26	Cloche 26 cm Ø, Teller 30 cm Ø	1	1	55.00 44.00



Buffet- und Tortenplatten Salzburg

Stilvolle Glas-Tortenplatten und Glas-Clochen, einzeln

		Stück		1
				20 %
140 58 22	Tortenplatte, H: 22 cm, 29 cm Ø	1	1	55.00 44.00
140 57 26	Cloche, 26 cm Ø	1	1	32.00 25.60



Buffet- und Tortenplatten

Melamin

		Stück		1
				20 %
270 36 00	H: 8 cm, 31 cm Ø	1	1	38.00 30.40
270 36 01	H: 16 cm, 31 cm Ø	1	1	47.00 37.60



Salatschüsseln

Aus Luran S, stapelbar, säure- und marinadenfest, bruchstabil, spülmaschinenfest, lichtecht und farbstabil

		Stück		1
				15 %
270 16 00	6-eckig, weiss, 1.8 l, 18.5 x 18.5 cm, H: 9.5 cm	1	1	14.00 11.90
270 16 99	6-eckig, schwarz, 1.8 l, 18.5 x 18.5 cm, H: 9.5 cm	1	1	14.00 11.90
270 15 00	8-eckig, weiss, 3 l, 23 x 23 cm, H: 10 cm	1	1	19.00 16.15
270 15 99	8-eckig, schwarz, 3 l, 23 x 23 cm, H: 10 cm	1	1	19.00 16.15



Salat- und Buffetbesteck Baguette

CNS 18/10

		Stück		1
150 20 51	Gemüselöffel, 26 cm	1	1	12.50
150 20 50	Gemüsegabel, 26 cm	1	1	12.50



NEW

ab
17.00



Salatsaucentöpfe

Porzellan weiss, mit Deckel aus CNS

		Stück	1	60	120
270 13 08	0.8 l, H: 13 cm, 13 cm Ø	1	1		17.00
270 13 20	2 l, H: 15 cm, 17 cm Ø	1	1		33.00
270 13 23	2.3 l, H: 17 cm, 18.5 cm Ø	1	1		34.00



Salatsaucentöpfe Buffet Gourmet

Porzellan by Seltmann Weiden Porzellan

		Stück	1	60	120
115 899 24	Salatsaucentopf, 1 l	1	1	25.30	20.24
115 914 58	Salatsaucentopf, 1.5 l	1	1	41.30	33.04



Salatsaucentopf CNS

CNS 18/10 matt, doppelwandig isoliert

		Stück	1	60	120
270 11 18	1.8 l, H: 18 cm, 15 cm Ø	1	1	64.00	57.60



Dressing-Topf Melamin

weiss

		Stück	1	60	120
270 06 10	1 l, H: 21.5 cm, 12 cm Ø	1	1	38.00	30.40



Salat-Servierzangen CNS 18/10

		Stück	1	60	120
270 21 00	Salat-Servierzange, 22 cm	1	1	49.00	15.20
270 22 00	Salat-Servierzange, 24 cm	1	1	41.90	9.52
270 23 00	Salat-/Spaghettizange, 24 cm	1	1	9.90	7.92



Salat- und Buffetbesteck

Aus Kunststoff für Festigkeit und Langlebigkeit, spülmaschinenfest

		Stück	1	60	120
270 00 10	Salat-Servierzange, 23 cm	1	1		3.50
270 00 11	Buffetlöffel glatt, 28 cm	1	1		4.60
270 00 12	Buffetlöffel gelocht, 28 cm	1	1		4.70
270 00 13	Schöpflöffel, 36 cm	1	1		5.20



Salatzange Radford Robert Welch

CNS 18/10

		Stück	1	60	120
152 15 50	24 cm	1	1	48.40	14.72



Salatbesteck CNS 18/10

		Stück	1	60	120
270 20 00	30 cm	1	1	27.00	21.60



Saucen-Schöpfer CNS 18/10

		Stück	1	60	120
151 50 53	19 cm	1	1	46.80	13.44
270 12 00	29 cm, 6.5 cm Ø, 0.05 l	1	1	24.00	19.20

Buffet

Metall-Tabletts

CNS 18/10

		Stück	1	6	12
				10 %	20 %
282 08 12	GN: 1/2, 32.5 x 26.5 cm	1	1	30.00	27.00 24.00
282 08 11	GN: 1/1, 53 x 32.5 cm	1	1	51.00	45.90 40.80



ab
24.-

Tablett Profi Line GN 1/1

CNS 18/10, mit einem zeitlosen, eleganten und pflegeleichten Dekorrand, stapelbar, passend in alle GN-Einrichtungen

		Stück	1	6	12
				54.00	48.60
251 61 11	53 x 32.5 cm	1	1	54.00	48.60



Metall-Tablett

CNS 18/8

		Stück	1	6	12
				48.00	38.40
282 09 47*	47 x 36 cm	1	1	48.00	38.40



Tabletts Sunday

CNS 18/8 hochglanzpoliert

		Stück	1	6	12
				32.00	28.80 25.60
252 22 12	GN: 1/2, 32.5 x 26.5 cm	1	1	32.00	28.80 25.60
252 22 11	GN: 1/1, 53 x 32.5 cm	1	1	56.00	50.40 44.80



Tabletts Top Line rechteckig

Die elegante, schlichte Linie in Profi-Ausführung zum exklusiven Preis-/Leistungsverhältnis. 18/8 Edelstahl, Rand mattiert, innen Hochglanz poliert, spülmaschinenfest

		Stück	1	6	12
				52.50	47.25 42.00
251 50 11	GN: 1/1, ohne Griffe, 53 x 32.5 cm	1	1	52.50	47.25 42.00
251 51 61	Griffe verchromt, 61.5 x 32.5 cm	1	1	74.00	66.60 59.20



Mobiler Hygieneschutz

Mobiler Hygieneschutz aus Acryl für Vitrinen, Buffets und Speisenwärmer.

		Stück	1	6	12
				288.00	230.40
270 45 00	82 x 42 cm, H: 45 cm	1	1	288.00	230.40



230.-

Kuppelhaube mit Front-Ausschnitt

Kuppelhaube GN 1/1 aus glasklarem Kunststoff mit Front-Ausschnitt und verchromtem Griff

		Stück	1	6	12
				80.00	64.00
252 61 11	GN: 1/1, 54 x 33 cm, H: 20 cm	1	1	80.00	64.00



NEW



Präsentierpiano-Sandwichtreppe

Edelstahl, mit 4 Fächern

		Stück		
252 33 56	56 x 8 cm, H: 5.5 cm	1	1	22.00 17.60
				1 20 %



Top Fresh - stapelbares Kühlsystem CNS

rund
CNS, Set 4-teilig, inkl. Kühlakku

		Stück		
251 86 23	H: 16.5 cm, 23 cm Ø	1	1	127.00 101.60
				1 20 %



Top Fresh - stapelbares Kühlsystem

4-teilig: 1 Kühlbox, 1 Tablett GN 1/1 und 2 Kühlakkus

		Stück		
251 75 11	4-teilig, GN: 1/1, H: 6.5 cm, 56.5 x 35 cm	1	1	196.00 156.80
251 76 11	Mit Rolltophaube	1	1	298.00 238.40
				1 20 %



Top Fresh - stapelbares Kühlsystem CNS

4-teilig: 1 Kühlbox, 1 Tablett GN 1/1 und 2 Kühlakkus

		Stück		
251 74 11	4-teilig, GN: 1/1, H: 8.5 cm, 56.5 x 36 cm	1	1	328.00 262.40
251 77 11	Mit Rolltophaube	1	1	418.00 334.40
				1 20 %



Hochstapler GN 1/1

CNS 18/10 poliert, stapelbares Tablett, Nutzhöhe 5 cm, Rand mit Prägedekor und massiven Bügelgriffen, spülmaschinenfest, vielseitig einsetzbar für den Partyservice, Catering, Speisetransportbehälter, Thermoboxen etc.

		Stück		
251 58 11	53 x 32.5 cm, Nutzhöhe 5 cm	1	1	67.00 60.30
				1 10 %



Thermobox GN 1/1

Beste Isoliereigenschaften für Lebensmittel von - 40 bis +120°C, stapelbar, einfaches Herausnehmen, bruchstabil, hygienisch, spülmaschinenfest.
Jede Box ist als Deckel- und Bodenteil verwendbar
59.5 x 39 cm

		Stück	1	6	12
252 00 12	H: 12 cm, Nutzhöhe 8 cm	1	1	62.00 55.80	49.60
252 00 16	H: 16 cm, Nutzhöhe 12 cm	1	1	64.00	57.60 51.20
252 00 00	Deckel flach	1	1	29.00	26.10 23.20
				10 %	20 %



Buffet

Servierbrett Akazie-Schiefer

Rustikales Servierbrett aus Akazienholz, mit einem Naturschieferstreifen zum Beschriften

		Stück			
252 36 36	36.5 x 15, H: 1.5 cm	1	1	29.00	23.20



NEW

Käseplatte Pure mit Glocke

Servierblech CNS, Holzbrett mit Rille, Rolltophaube mit verchromtem Knopf

		Stück			
251 88 45	Komplett 3-teilig, 44.5 cm Ø, H: 23 cm	1	1	127.00	101.60



Käseplatte Natural rund mit Rolltop-Haube

Grosse Käseplatte aus geöltem Buchenholz, passende Rolltophaube sorgt für guten Halt, Knopf in Chromstahl-Optik

		Stück			
251 67 00	Komplett, 50 cm Ø, H: 30.5 cm	1	1	191.00	152.80
251 67 10	Käseplatte einzeln, 50 cm Ø, H: 4 cm	1	1	121.00	96.80
251 67 50	Haube einzeln passend zu 251 67 00, Aussen Ø: 50 cm, H: 26 cm	1	1	89.00	71.20



Käseplatte Natural mit Rolltop-Haube GN 1/1

Käseplatte GN 1/1 aus geöltem Buchenholz, Rolltophaube mit Knopf in Chromstahl-Optik

		Stück			
251 72 00	Komplett, 58 x 38 cm, H: 19.5 cm	1	1	153.00	122.40
251 72 10	Käseplatte einzeln, 58 x 38 cm, H: 2.5 cm	1	1	69.00	55.20
251 72 50	Haube einzeln mit T-Griff in Chromstahl-Optik, 53 x 32.5 cm, H: 17 cm	1	1	99.00	79.20



Käsemesser

		Stück			
410 25 11	Bar-Käsemesser, 21.5 cm	1	1	5.30	4.77
410 25 26	Käsemesser mit gelochter Klinge, 25.5 cm	1	1	21.00	18.90
410 25 15	Parmesanmesser, 15 cm	1	1		37.90
410 26 17	Käseschaukel, 25 x 18 cm	1	1	49.80	44.82



Servierbretter Esche

Aus massiver Esche, lackiert

		Stück			
251 87 22	22 cm Ø, H: 2 cm	1	1		25.00
251 87 30	30 cm Ø, H: 2.5 cm	1	1		39.00
251 87 50	50 x 21 oval cm, H: 2 cm	1	1		29.00



Pizza- und Flammkuchenbrett Birke

Abmessung mit Griff 46 cm

		Stück			
252 31 30	29.5 x 28.5 cm, H: 0.6 cm	1	1		20.00





Etageren CNS

Edelstahl 18/10

		Stück		1
251 93 01	1-stufig, 17 cm Ø, H: 11 cm	1	1	21.00 16.80
251 93 02	2-stufig, 17/22 cm Ø, H: 23 cm	1	1	41.00 32.80

CHERRY Star

ab
15.84



Serviergestell Diverso

Präsentieren Sie Ihre Speisen, Häppchen, Gebäck, Desserts, Kuchen etc. platzsparend.
Gestell Metall hartverchromt (Gestell ohne Teller)

		Stück		1
251 85 01	Für Teller Ø bis 17 cm, 19.5 x 16 cm, H: 25.7 cm	1	1	19.80 15.84
251 85 04	Für Teller Ø 20 - 27 cm, 28.6 x 19 cm, H: 39.5 cm	1	1	42.00 33.60



Früchte Etagere CNS

Edelstahl 18/8 poliert, Edelstahl-Schale herausnehmbar

		Stück		1
252 29 53	32 cm Ø, H: 53 cm	1	1	145.00 116.00

52.-



Etagere CNS

Edelstahl 18/10 poliert

		Stück		1
251 93 03	3-stufig, 17/22/27 cm Ø, H: 31 cm	1	1	65.00 52.00



Schälchenspender

Geeignet für Schälchen mit 7,5 cm Ø, bestückbar mit bis zu 36 Schälchen

		Stück		1
260 65 18	Spender, 17.5 cm Ø, H: 25.5 cm	1	1	77.00
140 95 08	Glasschälchen, 7,5 cm Ø, H: 3 cm	6	1	0.80 0.72 0.64



Teebeutel-/Konfischälchen

		Stück		1
140 95 00	Glasschälchen, 6 cm Ø, H: 2.5 cm	6	1	0.70 0.63 0.56
131 19 07	Piano, 7.2 cm Ø, H: 2.3/3 cm	6	1	4.90 3.43

Buffet

Müesli-Dispenser Fresh + Easy

4.5 l Inhalt, Deckel aus Edelstahl 18/10, Fuss aus Alu-Guss poliert

260 09 45	17.5 x 22 cm, H: 52 cm, 4.5 l	1	Stück	1	109.00	1
-----------	-------------------------------	---	-------	---	--------	---



109.-

Cerealien-Bar, 5-teilig

1 Ständer aus Plexiglas, gefrostet und rutschfest, 2 Karaffen aus Polycarbonat mit schwenkbaren Edelstahldeckel, 2 luftdichte Frischhaltedeckel
Inhalt: 2 x 1.5 Liter
2 Ständerhöhen: 4 oder 8 cm

260 66 04	Ständer H: 4 cm, 26 x 17 cm, H: 29 cm	1	Stück	1	99.00	89.10	10 %
260 66 08	Ständer H: 8 cm, 26 x 17 cm, H: 32 cm	1	Stück	1	138.00	124.20	



Cerealien-Bar, 7-teilig

1 Ständer aus Plexiglas, gefrostet und rutschfest, 3 Karaffen aus Polycarbonat mit schwenkbaren Edelstahldeckel, 3 luftdichte Frischhaltedeckel
Inhalt: 3 x 1.5 Liter
2 Ständerhöhen: 4 oder 8 cm

260 06 15	Ständer H: 4 cm, 38 x 17 cm, H: 29 cm	1	Stück	1	125.00	112.50	10 %
260 06 32	Ständer H: 8 cm, 38 x 17 cm, H: 32 cm	1	Stück	1	175.00	157.50	



Präsentations-Schalen

Schalen klar mit Deckel, rostfreier Halter, ideal für Konfitüren, Saucen, Dips etc.

260 60 00	Präsentations-Schalen Set klein, 14 cm Ø, 0.35 l	1	Stück	1	125.00	100.00	20 %
260 61 00	Präsentations-Schalen Set gross, 23 cm Ø, 1.8 l	1	Stück	1	215.00	172.00	
140 74 14	Schale, 14 cm Ø, H: 6 cm	6	Stück	1	1.70	1.53	10 %
140 74 23	Schale, 23 cm Ø, H: 10.5 cm	6	Stück	1	4.40	3.96	10 %
260 60 50	Deckel zu Schalen, 14 cm Ø	1	Stück	1	21.00	16.80	20 %
260 61 50	Deckel zu Schale, 23 cm Ø	1	Stück	1	23.00	18.40	20 %



Schüsseln

140 74 14	14 cm Ø, H: 6 cm	6	Stück	1	1.70	1.53	1.36	10 %
140 74 23	23 cm Ø, H: 10.5 cm	6	Stück	1	4.40	3.96	3.52	10 %





Getränke-Dispenser Kilner

Der neueste Trend - servieren Sie mit dem Kilner-Getränkedispenser Drinks, Cocktails und Getränke wie Bowlen, Saft, Sirup. Ob an heißen oder kalten Tagen, der Kilner-Getränkedispenser eignet sich hervorragend für Buffets, Parties und mehr. Der Getränkedispenser kann dank dem Clip-Deckel einfach und schnell gefüllt werden, der praktische Dosierhahn erleichtert das Ausschöpfen und Dossieren.

		Stück		1
261 15 05	5 l, H: 31.5 cm, 18.5 cm Ø	2	1	49.00
261 15 08	8 l, H: 35.6 cm, 27.9 cm Ø	2	1	65.00
261 15 50	Fuss zu Dispenser 5 + 8 l	1	1	12.50

Drinking Jar Quattro Stagioni

Die trendigen Drinking Jar dürfen in keiner Bar fehlen und sorgen auch bei den Gästen für Gesprächsstoff.

		Stück	1	60	120
171 47 42	415 ml, H: 13.5 cm, 7.5 cm Ø	12	1	4.80	3.84
				10 %	20 %



Saft-Dispenser

8 l Inhalt
Edelstahl mit Eiswürfelkühler und Auffangschale, transparenter Behälter aus Polycarbonat mit solidem NonDrip Hahn

		Stück		1
260 03 80	26 x 36 cm, H: 56 cm	1	1	224.25
				25 %
				299.00



Saft-Dispenser Top Fresh

6 l Inhalt
2 Kühlakkus sorgen für eine optimale Kühlung der Getränke, Basis und Deckel aus Edelstahl 18/10, mit hartverchromtem Non-Drip Hahn, einfache Reinigung
23 x 35 cm, H: 47 cm

		Stück		1
260 00 60	Edelstahl, 23 x 35 cm, H: 47 cm	1	1	360.50
				30 %
				515.00
260 04 51	Kühlakku	1	1	9.40



Milch-Kanne Top Fresh

4 l Inhalt
Porzellan-Milch-Kanne, Kunststoff gefrostet, Edelstahl, inkl. Porzellanschild zum Beschriften, 1 Kühlakku
31 x 21 cm, H: 42 cm

		Stück		1
260 13 40	31 x 21 cm, H: 42 cm	1	1	376.20
				10 %
				418.00

Buffet

Milch-Dispenser Top Fresh

5 l Inhalt
Edelstahl 18/10, Kühlakku im Standfuss, hartverchromter Non-Drip Hahn, einfache Reinigung
23 x 35 cm, H: 47cm

		Stück		
				1
				30 %
260 04 50	Edelstahl, 23 x 35 cm, H: 47 cm	1	1	630.00 441.00
				1
260 04 51	Kühlakku	1	1	9.40



Samowar

CNS 18/10
Mit hitzeisolierten Griffen, Überhitzungsschutz, stufenlose Temperaturregelung, inkl. Teekanne 650 ml

		Stück		
				1
260 51 22	3.0 l, 30 x 26.5 cm, H: 33.5 cm, 230 V, 2200 W, 1.7 kg	1	1	189.00



Samowar Classic 5 Liter BEEM

Wasserbehälter und Teekanne aus hochwertigem Edelstahl mit Ablasshahn, 2 Heizspiralen à 1300 Watt und à 500 Watt, Abschaltautomatik beim Erreichen des Siedepunktes und Umstellung auf Warmhaltefunktion, stufenlos regulierbar, Überhitzungsschutz

Kochendes, heisses oder warmes Wasser steht jederzeit zur Verfügung, um den Tee zu verdünnen, Instantkaffee oder andere lösliche Getränke zuzubereiten und z.B. Glühwein zu erwärmen. Nicht für Milch geeignet

260 55 05: 5 l Wasserbehälter, 1.3 l Teekanne

		Stück		
				1
260 55 05*	5.0 l, 36.5 x 26.7 cm, H: 58 cm, 230 V, 1800 W, 4.73 kg		1	850.00



Thermos-Pumpkanne

Doppelwandig, mit Edelstahleinsatz, bedienerfreundliche Automatik mit Schieberegler Ein/Aus

		Stück		
				1
260 38 25	2.5 l, H: 36 cm, 15 cm Ø	1	1	44.50
260 38 35	3.5 l, H: 38 cm, 17 cm Ø	1	1	58.50



Getränke-Spender CNS

Für Heiss- oder Kalt-Getränke, isoliert, innen und aussen CNS, Wärmespeicherung nach 6 Std. ca. 65° C.

Nicht für Milch geeignet!

		Stück		
				1
				40 %
260 47 12	12 l, 28 cm Ø, H: 39 cm	1	1	165.00 99.00





Isolier-Getränke-Spender

Oberteil aus Edelstahl, Sockel aus Kunststoff, mit Füllstandsanzeiger und mit Zapfhahn, herausnehmbares Tropfblech. Oberteil abnehmbar, geringer Temperaturverlust – bei einer Einfülltemperatur von 95 °C beträgt die Temperatur nach 6 Stunden noch ca. 78–81 °C (gemessen bei durchschnittlicher Raumtemperatur)

			Stück		1
260 56 04	4 l, 23 x 35 cm, H: 52 cm, 4.2 kg	1	1	279.00	223.20
260 56 08	8 l, 23 x 35 cm cm, H: 63 cm, 5 kg	1	1	313.00	250.40



Glühweinkocher

Für Glühwein, Tee, Kaffee, Suppen etc., zum Kochen, Warmhalten und Einkochen. Temperatur von 30 - 100° C, stufenlos einstellbar, mit Trockenlaufsicherung, Innenbehälter aus emailliertem Stahl, säure- und laugenfest

			Stück		1
260 53 30	30 l, CNS, 35 cm Ø, 230 V, 1800 W	1	1	398.00	278.60



Kaffeemaschine Gastro 6005

6.75 l Inhalt, 1 Kaffeebrühvorgang für 40 Tassen, Aufbrühzeit 30 - 35 Min, Druckpumpsystem, Kaffeefilter aus CNS, Heizelement antihafbeschichtet, kein Verkalken, auch für Tee und Instantgetränke geeignet

			Stück		1
260 22 07	6.75 l, 23.5 cm Ø, H: 48 cm, 230 V, 1500 W, 3.6 kg	1	1	240.00	168.00
460 58 21	Kaffee Rundfilter mit Zentrumsloch, 193 mm, 8 mm Ø	1	100		28.50



Heissgetränke- und Wasser-Spender doppelwandig

Doppelwandig - geringerer Wärmeverlust und sparsamer Energieverbrauch
Ideal zum Warmhalten von Glühwein, Jagertee oder Heisswasser für Tee, Gehäuse und Deckel aus Edelstahl, mit Füllstandsanzeiger, Temperaturregler von 30 - 100° C
Nicht für Milch geeignet!

			Stück		1
261 06 09	8,5 l, 22,5 cm Ø, H: 47 cm, 230 V, 1600 W, 2,65 kg	1	1		133.00



Heissgetränke- und Wasser-Spender

Heisse Getränke für jeden Anlass!
Ideal zum Warmhalten von Glühwein, Jagertee oder Heisswasser für Tee, Gehäuse und Deckel aus Edelstahl, Sockel aus Kunststoff, mit Füllstandsanzeiger, Temperaturregler von 30 - 100° C
Nicht für Milch geeignet!

			Stück		1
260 48 10	10 l, 20,5 cm Ø, H: 50,5 cm, 230 V, 2500 W, 2,3 kg, Stecker Typ: 23	1	1		152.00

Buffet

Multi-Therm

Heisse Getränke für jeden Anlass!

Ideal zum Warmhalten von Glühwein, Jägertee oder Heisswasser für Tee, Gerät aus Edelstahl, Temperaturregler von 30 - 90° C mit Überhitzungsschutz. Mindest-Füllmenge 2 l Nicht für Milch geeignet!

		Stück		1
260 51 20	18 l, 27 cm Ø, H: 61 cm, 230 V, 2000 W, 4.8 kg	1	1	238.00



Getränke-Spender Cantainer

Für perfekte Mobilität, optimal isoliert, hält Getränke stundenlang kalt oder warm, stapelbar, mit 2 Traggriffen, Aussparung zum Unterstellen von breitrandigen Trinkgefäßen, Zapfhahn

		Stück		1
260 40 09	10.4 l, 42.5 x 30 cm, H: 50 cm, 7.7 kg	1	1	504.00 403.20
260 40 18	20 l, 42.5 x 30 cm, H: 68 cm, 9.5 kg	1	1	567.00 453.60
260 40 37	40 l, 52 x 30 cm, H: 65.5 cm, 13.8 kg	1	1	783.00 626.40



Milcherhitzer ANIMO-Economie

Gehäuse doppelwandig und Behälter vollständig aus rostfreiem Stahl 18/9, für das Gastgewerbe, Grossküchen, Spitäler und Kantinen, einfache Bedienung, leichte Reinigung

- Thermostat von 30 - 85°C stufenlos regulierbar, keine Schaumbildung
- Dank Wasserbad-System kein Kleben der Milch
- Trockenlauf-Sicherung
- Tomlinson-Zapfhahn aus Kunststoff
- 4 Gummifüsse

		Stück		1
260 49 05	5 l, H: 41.5 cm, Anschluss 230 V, Leistung 2.2 kW	1	1	1650.00
260 49 10	10 l, H: 43 cm, Anschluss 400/2V, Leistung 3.325 kW, Muss durch Elektriker angeschlossen werden	1	1	2395.00
260 49 20	20 l, H: 53.5 cm, Anschlusswert 400/3, Leistung 6.6 kW, Muss durch Elektriker angeschlossen werden	1	1	3450.00
260 49 50	Reinigungsmittel, 1 l, Schnelles und gründliches Lösen von Milchresten	1	1	30.00



Profi

Milch-/Universalkrug "Antihaft"

Edelstahl, PTFE-antihafbeschichtet, perfekt für die Herstellung von Milchschaum

		Stück		1
261 02 04	0.35 l, H: 10 cm	1	1	26.00 20.80
261 02 06	0.6 l, H: 11.5 cm	1	1	32.00 25.60
261 02 08	0.8 l, H: 13 cm	1	1	32.00 25.60



Milchkrüge CNS 18/10

		Stück	1	30	60
260 35 01	0.15 l, H: 6.5 cm	1	1	23.40	18.72
260 35 02	0.23 l, H: 7.5 cm	1	1	28.80	23.04
260 37 03	0.35 l, H: 9 cm	1	1	16.90	13.52
260 37 06	0.6 l, H: 11 cm	1	1	19.90	15.92
260 37 10	0.9 l, H: 12.5 cm	1	1	26.90	21.52
260 37 15	1.5 l, H: 16 cm	1	1	38.90	31.12
260 37 20	2 l, H: 18 cm	1	1	44.20	35.36





Kaffeekrüge CNS 18/10

		Stück	1	30	60
260 38 03	0.3 l, H: 10.5 cm	1	1	22.90	18.32
260 38 06	0.6 l, H: 13 cm	1	1	27.90	22.32
260 38 10	1 l, H: 15 cm	1	1	31.90	25.52
260 38 15	1.5 l, H: 19 cm	1	1	46.90	37.52
260 38 20	2 l, H: 21 cm	1	1	56.90	45.52
		Stück			1
260 31 03*	0.3 l, H: 16.5 cm	1	1	78.00	39.00



Kannen-Handschutz

Zellstoffwatte 9-lagig, weiss

		Stück	1	12
260 14 00	5 x 8 cm	1	500	72.25
			100 =	13.43
				85.00
				15.80



Krüge Porzellan

		Stück	1
133 33 03	weiss, 0.2 l, H: 10 cm	6	5.50
133 33 05	weiss, 0.5 l, H: 13 cm	6	7.70
133 33 13	weiss, 1.25 l, H: 17.5 cm	6	11.80

39.-



Kaffeekanne doppelwandig CNS 18/8

Satiniert, doppelwandig, mit nur einer Hand zu bedienen

		Stück	1
260 31 03*	0.3 l, H: 16.5 cm	1	39.00
			78.00

41.-



Kaffeekannen doppelwandig CNS 18/8

Hochglanzpoliert, mit nur einer Hand zu bedienen, Hohlgriff, Ausgiesser geformt, schwere Qualität

		Stück	1
260 32 03*	0.3 l, H: 18 cm	1	41.00
			82.00



Kaffeekannen doppelwandig CNS 18/8

Hochglanzpoliert, mit nur einer Hand zu bedienen, schwere Qualität

		Stück	1
260 31 04*	0.4 l, H: 15 cm	1	45.00
260 31 06*	0.6 l, H: 16 cm	1	53.00
260 31 08*	0.8 l, H: 18 cm	1	60.00
			90.00
			106.00
			120.00

Buffet

Isolierkannen Helios Wave S+

Spülmaschinenfest bis 95°C, unzerbrechlicher Isoliereinsatz aus rostfreiem, doppelwandigem Edelstahl für eine lange Warmhaltung der Getränke, 3 Jahre Garantie

		Stück	1	30	60
				10 %	20 %
260 33 10	1 l, H: 25.2 cm, 16.5 cm Ø, weiss	1	1	61.00	54.90 48.80
260 34 10	1 l, H: 25.2 cm, 16.5 cm Ø, schwarz	1	1	61.00	54.90 48.80



Isolierkannen mattiert

CNS 18/10, spülmaschinenfest, das Klappdeckelsystem garantiert eine einfache Einhandbedienung

		Stück	1	30	60
				10 %	20 %
260 27 03	0.3 l, H: 14 cm	1	1	60.00	54.00 48.00
260 27 06	0.6 l, H: 19 cm	1	1	73.00	65.70 58.40
260 27 10	1 l, H: 20.5 cm	1	1	96.00	86.40 76.80



Isolierkannen Helios Brilliant Edelstahl

Die Vollmetallkanne ist spülmaschinenfest und unzerbrechlich. Das Klappdeckelsystem garantiert eine einfache Einhandbedienung. 3 Jahre Garantie für Warmhaltung

		Stück	1	30	60
				20 %	20 %
260 39 06	0.6 l, 11.2 cm Ø, H: 16 cm	1	1	79.00	63.20
260 39 10	1 l, 12.7 cm Ø, H: 19 cm	1	1	86.00	68.80
260 39 15	1.5 l, 14 cm Ø, H: 22 cm	1	1	93.00	74.40



Isolierkannen Diamant

Doppelwandig mit Deckel, CNS 18/10

		Stück	1	30	60
				10 %	20 %
260 31 10	1 l, H: 18 cm, 14 cm Ø	1	1	35.00	31.50 28.00
260 31 15	1.5 l, H: 23.5 cm, 14 cm Ø	1	1	37.00	33.30 29.60
260 31 20	2 l, H: 24 cm, 14 cm Ø	1	1	45.00	40.50 36.00



Kaffeekrüge Neutral CNS 18/10

Doppelwandig

		Stück	1	30	60
				20 %	20 %
260 28 03	0.3 l, H: 16 cm	1	1	97.50	78.00
260 28 06	0.6 l, H: 20 cm	1	1	106.90	85.52
260 28 12	1.2 l, H: 24.5 cm	1	1	150.70	120.56



ab
78.-



Kaffeekrüge Excellent CNS 18/10

Klassischer Kaffeekrug mit Hohlgriff, in schwerer Ausführung

		Stück	1	30	60
				20 %	20 %
260 29 03	0.3 l	1	1	196.00	156.80
260 29 06	0.6 l	1	1	245.80	196.64



Milchkrüge Excellent CNS 18/10

Klassischer Milchkrug mit Hohlgriff, in schwerer Ausführung

		Stück	1	30	60
				20 %	20 %
260 29 15	0.15 l	1	1	124.50	99.60
260 29 30	0.3 l	1	1	151.80	121.44



Gekühlte Buffets auf Rollen

Formschöne, moderne und elegante Buffets in edler Holz- und Chrom-Optik

Als Frühstück- oder Hors-d'oeuvre-Buffet, Salat- oder Apéro-Bar, zur Präsentation von Fischen und Meeresfrüchten etc. Für GN-Schalen bis H: 200 mm. Alle Modelle mit Edelstahl-Wanne, stiller Kühlung, automatischer Enteisung und Ventilator. Regulierbar von 0°/+10° C.

In dunkler Wenge, heller Kirsche oder jeder gewünschten RAL-Farbe erhältlich



Kühlbuffet Essence Green

Mit fixem Hygieneschutz aus Glas und zeitgemässer LED-Beleuchtung. In 3 verschiedenen Grössen erhältlich: 3 x GN 1/1, 4 x GN 1/1 und 6 x GN 1/1.

Weitere Modelle (auch warm) und Farben auf Anfrage

			Stück		1 20 %
271 08 01	GN: 3 x 1/1, Kirsche hell, 116.9 x 65 cm, H: 131.8 cm, 230 V, 272 W	1	1	3900.00	3120.00
271 08 02	GN: 3 x 1/1, Wenge dunkel, 116.9 x 65 cm, H: 131.8 cm, 230 V, 272 W	1	1	3900.00	3120.00
271 09 01	GN: 4 x 1/1, Kirsche hell, 149.4 x 65 cm, H: 131.8 cm, 230 V, 272 W	1	1	4200.00	3360.00
271 09 02	GN: 4 x 1/1, Wenge dunkel, 149.4 x 65 cm, H: 131.8 cm, 230 V, 272 W	1	1	4200.00	3360.00
271 10 01	GN: 6 x 1/1, Kirsche hell, 214.4 x 65 cm, H: 131.8 cm, 230 V, 341 W	1	1	5200.00	4160.00
271 10 02	GN: 6 x 1/1, Wenge dunkel, 214.4 x 65 cm, H: 131.8 cm, 230 V, 341 W	1	1	5200.00	4160.00



Kühlbuffet Tradition Green

Mit elektrisch absenkbarem Plexiglas als Hygieneschutz und zeitgemässer LED-Beleuchtung. In 3 verschiedenen Grössen erhältlich: 3 x GN 1/1, 4 x GN 1/1 und 6 x GN 1/1.

Weitere Modelle (auch warm) und Farben auf Anfrage

			Stück		1 20 %
271 13 01	GN: 3 x 1/1, Kirsche hell, 116.9 x 65 cm, H: 148.1 cm, 230 V, 272 W	1	1	5600.00	4480.00
271 13 02	GN: 3 x 1/1, Wenge dunkel, 116.9 x 65 cm, H: 148.1 cm, 230 V, 272 W	1	1	5600.00	4480.00
271 11 01	GN: 4 x 1/1, Kirsche hell, 149.4 x 65 cm, H: 148.1 cm, 230 V, 272 W	1	1	5990.00	4792.00
271 11 02	GN: 4 x 1/1, Wenge dunkel, 149.4 x 65 cm, H: 148.1 cm, 230 V, 272 W	1	1	5990.00	4792.00
271 12 01	GN: 6 x 1/1, Kirsche hell, 214.4 x 65 cm, H: 148.1 cm, 230 V, 341 W	1	1	6800.00	5440.00
271 12 02	GN: 6 x 1/1, Wenge dunkel, 214.4 x 65 cm, H: 148.1 cm, 230 V, 341 W	1	1	6800.00	5440.00



Kühlbuffet Tradition Square

Mit elektrisch absenkbarem Plexiglas als Hygieneschutz und zeitgemässer LED-Beleuchtung. In 2 verschiedenen Grössen erhältlich: 4 x GN 1/1 und 8 x GN 1/1.

Weitere Modelle (auch warm) und Farben auf Anfrage

			Stück		1 20 %
271 15 01	GN: 4 x 1/1, Kirsche hell, 116.9 x 97.2 cm, H: 148.1 cm, 230 V, 272 W	1	1	7700.00	6160.00
271 15 02	GN: 4 x 1/1, Wenge dunkel, 116.9 x 97.2 cm, H: 148.1 cm, 272 W, 230 V	1	1	7700.00	6160.00
271 16 01	GN: 8 x 1/1, Kirsche hell, 149.4 x 121.2 cm, H: 148.1 cm, 230 V, 341 W	1	1	8600.00	6880.00
271 16 02	GN: 8 x 1/1, Wenge dunkel, 149.4 x 121.2 cm, H: 148.1 cm, 230 V, 341 W	1	1	8600.00	6880.00

Buffet

Wärme Buffets Tradition

Für die Selbstbedienung oder die Speiseausgabe warmer Gerichte.

Buffet auf Rollen, leicht zu verschieben, mit edler Holz-/Chromoptik, Hygieneschutz aus Acryl, elektrisch, mit Wärmestrahlern und Bedienpanel

Wärmebuffet Tradition Red

Zum Warmhalten von Speisen im Dampfbad. Wanne mit hygienisch, abgerundeten Ecken und Ablasshahn, Thermostat regulierbar 60°C bis 90°C mit Überhitzungsschutz, für GN-Behälter bis max H: 200 mm

Weitere Modelle und Farben auf Anfrage

		Stück	1	
			5800.00	20 %
271 19 01	GN: 3 x 1/1, Kirsche hell, 116.9 x 65 cm, H: 148.1 cm, 230 V, 2200 W	1	1	4640.00
271 19 02	GN: 3 x 1/1, Wenge dunkel, 116.9 x 65 cm, H innen: 148.1 cm, 230 V, 2200 W	1	1	4640.00
271 21 01	GN: 4 x 1/1, Kirsche hell, 149.4 x 65 cm, H: 148.1 cm, 230 V, 3050 W	1	1	5200.00
271 21 02	GN: 4 x 1/1, Wenge dunkel, 149.4 x 65 cm, H: 148.1 cm, 230 V, 3050 W	1	1	5200.00
271 22 01	GN: 6 x 1/1, Kirsche hell, 214.4 x 65 cm, H: 148.1 cm, 230 V, 4400 W	1	1	6480.00
271 22 02	GN: 6 x 1/1, Wenge dunkel, 214.4 x 65 cm, H: 148.1 cm, 230 V, 4400 W	1	1	6480.00



Wärmebuffet Tradition Brown

Zum Warmhalten von Speisen auf Wärmeplatte, Warmhalteplatte aus Hartglas mit gut gekennzeichneten Heizzonen, regulierbar 60°C bis 100°C, mit Thermostat und Überhitzungsschutz

Weitere Modelle und Farben auf Anfrage

		Stück	1	
			5900.00	20 %
271 24 01	GN: 3 x 1/1, Kirsche hell, 116.9 x 65 cm, H: 148.1 cm, 230 V, 1905 W	1	1	4720.00
271 24 02	GN: 3 x 1/1, Wenge dunkel, 116.9 x 65 cm, H: 148.1 cm, 230 V, 1905 W	1	1	4720.00
271 25 01	GN: 4 x 1/1, Kirsche hell, 149.4 x 65 cm, H: 148.1 cm, 230 V, 2090 W	1	1	5360.00
271 25 02	GN: 4 x 1/1, Wenge dunkel, 149.4 x 65 cm, H: 148.1 cm, 230 V, 2090 W	1	1	5360.00
271 26 01	GN: 6 x 1/1, Kirsche hell, 214.4 x 65 cm, H: 148.1 cm, 230 V, 3110 W	1	1	7280.00
271 26 02	GN: 6 x 1/1, Wenge dunkel, 214.4 x 65 cm, H: 148.1 cm, 230 V, 3110 W	1	1	7280.00



Alle Kühl- und Wärmebuffets sind in jeder gewünschten RAL-Farbe erhältlich

Der Aufpreis beträgt +10 % auf den Nettopreis



Wir beraten Sie gerne

Weitere Buffets von Blanco auf Seite 335





Servicestation Premium

Servicestation in kunststoffbeschichtetem Kirschbaum-Dekor
- 2 Türen
- 1 Tablar
- ausziehbare Besteckschublade mit 6 hulu-Besteckboxen
- 4 Lenkrollen, 2 mit Feststeller

			Stück		1
250 10 00	100 x 53 cm, H: 100 cm, 55 kg		1	1	2680.00 2144.00



Bankett- und Servicewagen

Edelstahlgestell in schwarz, Einlegeböden und Seitenwände in elegantem Anthrazit, die Einlegeböden sind höhenverstellbar
- 4 Lenkrollen, 2 mit Feststeller
- belastbar bis 200 kg
- Gewicht 76 kg

			Stück		1
250 20 98	111 x 63 cm, 3 Tablare, Zwischenraum: 24 cm, H: 130 cm		1	1	1890.00 1512.00



Servicestation wetterfest

Wetterfest in Wenge-Dekor
Stabiles und pulverbeschichtetes Edelstahlgestell
- 1 Besteckschublade
- 1 Flügeltüre
- 1 Flachboden
- 4 Lenkrollen, 2 mit Feststeller

			Stück		1
250 19 85	112 x 53.5 cm, H: 107 cm		1	1	4600.00 4140.00



Servierwagen in Wenge-Dekor

Stabiles und pulverbeschichtetes Edelstahlgestell, Einlegeböden aus kunststoffbeschichteten Platten mit Holzstruktur
- 4 Lenkrollen, 2 mit Feststeller
- Tragkraft bis 100 kg
- Gewicht 45 kg

			Stück		1
250 20 85	3 Tablare, Zwischenraum: 24 cm, 115 x 53 cm, H: 97 cm		1	1	3190.00 2552.00



Digestifwagen in Wenge-Dekor

Stabiles und pulverbeschichtetes Edelstahlgestell
Einlegeböden aus kunststoffbeschichteten Platten mit Holzstruktur
- 4 Lenkrollen, 2 mit Feststeller
- Tragkraft bis 100 kg
- Gewicht 45 kg

			Stück		1
250 18 85	3 Tablare, inklusive handliche Ablage für Spirituosen, 115 x 53 cm, H: 97 cm		1	1	3290.00 2632.00

Buffet

hulu Servicestation CNS

3 geschlossenen Seiten, ausziehbares Besteckfach mit 6 hulu-Boxen, belastbar bis 80 kg, 4 Lenkrollen 12.5 cm Ø, 2 Feststeller

		Stück		
				1 30 %
280 55 00	90 x 60 cm, H: 90 cm	1	1	2220.00 1554.00
280 60 00	Mit Türen, 90 x 60 cm, H: 90 cm	1	1	2550.00 1785.00
		Stück		1
280 50 50	Abräum-Besteckbox CNS, GN 1/3, H: 20 cm	1	1	79.00
280 50 51	Abfallbehälter CNS, 42 x 22 cm, H: 25 cm	1	1	290.00



hulu Servicestation CNS

Ohne ausziehbarem Besteckfach und Abfallbehälter belastbar bis 80 kg, 4 Lenkrollen 12.5 cm Ø, 2 Feststeller

		Stück		
				1 10 %
280 50 00	90 x 60 cm, H: 95 cm	1	1	1590.00 1431.00
		Stück		1
280 50 50	Abräum-Besteckbox CNS, GN 1/3, H: 20 cm	1	1	79.00
280 50 51	Abfallbehälter CNS, 42 x 22 cm, H: 25 cm	1	1	290.00



Servierwagen CNS mit Flügeltüren

Mit 3 geschlossenen Seiten und frontseitigen Flügeltüren, belastbar bis 120 kg, 4 Lenkrollen 12.5 cm Ø, 2 mit Feststeller

Verkleidung: Feinblech, doppelseitig elektrolytisch verzinkt, pulverbeschichtet in verschiedene Farben

		Stück		
				1 20 %
421 44 50	Grannygrün, 3 Tablare, Zwischenraum: 27.5 cm, 90 x 60 cm, H: 95 cm	1	1	1050.00 840.00

Andere Modelle auf Anfrage



hulu Service-Tische

Bis 5 hulu Service-Tische können gestapelt werden. Bis zu 3 Rechaudplatten finden auf dem Tischblatt Platz, Gestell Metall verchromt, Tischblatt und Tablar beschichtet, 4 Lenkrollen

		Stück		
				1 20 %
250 02 00	72 x 41 cm, H: 74 cm	1	1	398.00 318.40



Service

abert...

brabantia

Dinetray®



premi Star

steelite
INTERNATIONAL



EMINGER
KITCHENWARE



Reinhold Weich

TTM

Bartscher

CAMBRO

Flambi-Spiess®

Kisag



WESBO AG

BLANCO

chicco

FIGGJA
KITCHEN



Servitray®

Blue Flame

COLE & MASON

kelios





Service

Tischzubehör
Getränke / Menükarten
Werbetafeln
Tablett
Kinder
Personal

Tischständer Terrasse

Die massiven Tischständer aus Chromnickelstahl sind windfest und standsicher, somit universell einsetzbar - Drinnen wie auch im Freien

ab
15.92

primStar



Kartenhalter Terrasse

		Stück	1	12	30
200 00 00	9 cm Ø, H: 14 cm	1	1	19.90	17.91
200 00 50	Mit Tischnummer	1	1	21.90	19.71
					15.92
					17.52

primStar



Salz-/Pfeffer-Menage

		Stück	1	12	30
200 04 00	11 x 7 cm, H: 14 cm	1	1	34.60	32.87
					31.14

primStar



Salz-/Pfeffer-Menage

3-teilig, mit Zahnstocher-Glas

		Stück	1	12	30
200 03 00	10.5 cm Ø, H: 16 cm	1	1	41.00	36.90
					32.80

primStar



Öl-/Essig Menagen

		Stück	1	12	30
200 05 00	15 x 9.2 cm, H: 21 cm	1	1	42.00	37.80
					33.60
200 05 60	Ersatzglas Öl/Essig	1	1		9.50

primStar



Menage/Kartenhalter mit Pfeffer- und Salzmühle

Menu-Kartenhalter und Menage in einem – ideal auch für den Einsatz auf der Terrasse. Dem Zeitgeist entsprechend nicht mit Streuern sondern mit wertigen Pfeffer- und Salzmøhlen von Cole Mason. Halter aus CNS, schwere Ausführung, standfest, Qualitäts-Møhlen mit Stahl- bzw. Keramik-Mahlwerk. Design brunelli

		Stück	1	12	30
200 15 00	12.7 x 9.5 cm, H: 14.3 cm	1	1	79.00	67.15
					55.30

primStar



Menagen Pro

		Stück	1	12	30
200 11 01	Salz, Pfeffer, 8.5 x 11.5 cm, H: 11.5 cm	1	1	10.00	9.00
200 11 02	Salz, Pfeffer, Zahnstocher, 9.2 x 8.5 cm, H: 11.5 cm	1	1	14.00	12.60
200 11 03	Öl, Essig, 12 x 8 cm, H: 19 cm	1	1	20.00	18.00

Service

Holzkiste Vintage

Schubladenoptik mit Knopf

		Stück		1	20 %
204 13 00	Hell, 18.5 x 18.5 cm, H: 11 cm	1	1	21.00	16.80
204 13 95	Dunkel, 18.5 x 18.5 cm, H: 11 cm	1	1	21.00	16.80



NEW

Menagen Caddy Vintage

aus Pinienholz, herausnehmbare Aufteilung, 4-Fächer (7 x 7 cm)

		Stück		1	20 %
204 11 00	white, 17 x 17 cm, H: 10 cm	1	1	30.00	24.00
204 11 15	yellow, 17 x 17 cm, H: 10 cm	1	1	30.00	24.00
204 11 56	green, 17 x 17 cm, H: 10 cm	1	1	30.00	24.00



Menage-Caddy

Schlicht und vielseitig einsetzbar, Verarbeitung aus Akazienholz, Seidenglanz lackiert
Überraschen Sie Ihre Gäste mit diesem Hingucker

		Stück		1	20 %
204 10 00	25 x 15 cm, H: 18 cm	1	1	50.00	40.00



Käse-Menage/Streuer

		Stück	1	12	30
200 07 00	Käse-Menage mit Käselöffel, 11.5 cm Ø, H: 7 cm	1	1	23.90	21.51
200 07 60	Ersatzglas, 8.5 cm Ø	1	1		4.50
200 39 00	Käsestreuer, 7.8 cm Ø, H: 12 cm	1	1	9.10	8.65



Salz- und Pfefferstreuer

Deckel aus CNS

		Stück	1	12	30
200 34 00	H: 11 cm	1	1	3.00	2.70



Streuer/Zahnstocher-Glas

Kristallglas, CNS Deckel

		Stück	1	12	30
200 10 04	Salz-/Pfefferstreuer	1	1	7.50	7.13
200 10 03	Zahnstocher-Glas	1	1	7.50	7.13



Coupons/Zahnstocher Glas

		Stück	1	60	120
170 45 00	H: 58 mm, 48 mm Ø	12	1	1.10	0.99



COLE & MASON



Salz- und Pfeffermühlen Pina aus Acryl

		Stück		1
200 57 14	Salzmühle, H: 12.5 cm	4	1	49.90 13.93
200 56 14	Pfeffermühle, H: 12.5 cm	4	1	49.90 13.93

COLE & MASON



Salz- und Pfeffermühlen Set Duo aus Acryl

		Stück		1
200 54 07	Set Salz- und Pfeffermühle, H: 6.5 cm, 4.3 cm Ø	2	1	14.90 10.43
137 09 22	Figgjo Porzellan GN 1/16 Schale, 12 x 7.5 cm	6	1	12.00
			12	10.80
			30	9.60

COLE & MASON



Salz- und Pfeffermühlen Capstan aus Acryl

		Stück		1
200 71 09	Salzmühle, H: 8.5 cm	6	1	14.90 10.43
200 70 09	Pfeffermühle, H: 8.5 cm	6	1	14.90 10.43

COLE & MASON

Set
14.90



Salz- und Pfeffermühlen 575 aus Acryl

		Stück		1
200 29 00	Salzmühle, H: 10 cm	6	1	12.90 9.03
200 29 01	Pfeffermühle, H: 10 cm	6	1	12.90 9.03
200 29 02	Set Salz- und Pfeffermühle, H: 10 cm	1	2	14.90

COLE & MASON



Salz- und Pfeffermühlen 505 aus Acryl

		Stück		1
200 73 14	Salzmühle, H: 14 cm	4	1	17.90 12.53
200 72 14	Pfeffermühle, H: 14 cm	4	1	17.90 12.53

COLE & MASON



Salz- und Pfeffermühlen Inverta Flip aus Acryl

Die clevere Mühle - Inverta Flip steht umgedreht auf dem Tisch und verhindert so Salz- und Pfeffer-Rückstände

		Stück		1
200 67 15	Salzmühle, H: 15.4 cm	4	1	24.90 17.43
200 66 15	Pfeffermühle, H: 15.4 cm	4	1	24.90 17.43

COLE & MASON



Salz- und Pfeffermühlen Genoa Forest

Moderne Mühlen aus Buchenholz und Acryl

		Stück		1
200 76 17	Salzmühle, H: 16.5 cm	4	1	49.90 15.92
200 75 17	Pfeffermühle, H: 16.5 cm	4	1	49.90 15.92

Salz- und Pfeffermühlen Ardingly

Attraktive Mühlen in klassischem Design aus gebeiztem Holz
Hochwertiges Mahlwerk mit voreingestellten Mahlgraden von fein bis grobkörnig

Salzmühle: 3 Einstellpositionen
Pfeffermühle: 6 Einstellpositionen

		Stück		1
				20 %
200 84 22	Salzmühle, braun, H: 22 cm	1	1	59.00 47.20
200 83 22	Pfeffermühle, braun, H: 22 cm	1	1	59.00 47.20
200 82 22	Salzmühle, karbongrau, H: 22 cm	1	1	59.00 47.20
200 81 22	Pfeffermühle, karbongrau, H: 22 cm	1	1	59.00 47.20

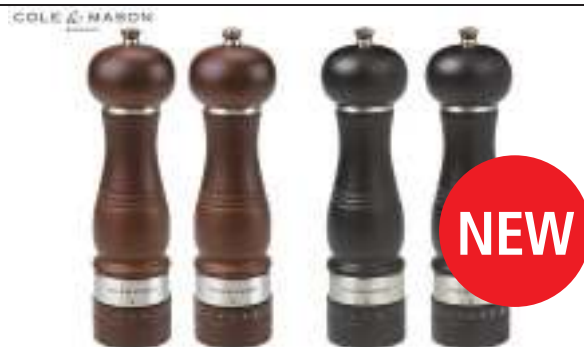

Salz- und Pfeffermühlen Horsham

Attraktive Mühlen im Kupfer-Look mit hochwertigem Mahlwerk

Salzmühle: 3 Einstellpositionen
Pfeffermühle: 6 Einstellpositionen

		Stück		1
				20 %
200 86 15	Salzmühle, H: 15.4 cm	2	1	34.90 27.92
200 85 15	Pfeffermühle, H: 15.4 cm	2	1	34.90 27.92



Salz- und Pfeffermühlen Derwent

Attraktive Mühlen im Kupfer-Look mit hochwertigem Mahlwerk

Salzmühle: 3 Einstellpositionen
Pfeffermühle: 6 Einstellpositionen

		Stück		1
				20 %
200 88 19	Salzmühle, H: 19 cm	2	1	49.90 39.92
200 87 19	Pfeffermühle, H: 19 cm	2	1	49.90 39.92



Salz- und Pfeffermühlen Capstan Forest

Elegante Salz- und Pfeffermühle aus dunkel gebeizter Buche

		Stück		1
				30 %
200 61 12	Salzmühle, H: 12 cm	6	1	49.90 13.93
200 60 12	Pfeffermühle, 12 cm	6	1	49.90 13.93
200 61 20	Salzmühle, H: 20 cm	4	1	27.90 19.53
200 60 20	Pfeffermühle, H: 20 cm	4	1	27.90 19.53
200 60 32	Pfeffermühle, H: 31.5 cm	1	1	49.90 34.93
200 60 41	Pfeffermühle, H: 40.5 cm	1	1	54.00 37.80



Salz- und Pfeffermühlen Windsor Black

Die Premium-Mühlen mit Federmechanismus mahlen sehr gleichmäßig. Die Pfeffermühle verfügt über ein maßgeschneidertes Mahlwerk aus gehärtetem Karbonstahl für höchste Mahlleistung. In der Salzmühle befindet sich ein diamantscharfes Keramikmahlwerk.

		Stück		1
				20 %
200 51 12	Salzmühle, H: 12 cm	6	1	24.90 19.92
200 50 12	Pfeffermühle, H: 12 cm	6	1	29.90 23.92
200 51 18	Salzmühle, H: 18 cm	4	1	29.90 23.92
200 50 18	Pfeffermühle, H: 18 cm	4	1	29.90 23.92



NEW



Salz- und Pfeffermühlen Vintage

Mühlen aus deutschem Buchenholz im Vintage-Look, Mahlgrad stufenlos einstellbar
Salzmühle: Mahlwerk aus Edelstahl
Pfeffermühle: Mahlwerk aus Carbonstahl

		Stück		1	6	12
200 89 15	Salzmühle white, H: 15 cm	6	1	34.00	27.20	20.00
200 90 15	Pfeffermühle green, H: 10 cm	6	1	34.00	27.20	20.00

Salz- und Pfeffermühlen Peugeot Fidji

CNS/schwarz



		Stück		1	6	12
204 23 12	Salzmühle, H: 12 cm	1	1	34.00	30.60	27.20
204 22 12	Pfeffermühle, H: 12 cm	1	1	34.00	30.60	27.20
204 23 15	Salzmühle, H: 15 cm	1	1	45.00	40.50	36.00
204 22 15	Pfeffermühle, H: 15 cm	1	1	45.00	40.50	36.00
204 25 20	Salzmühle, H: 20 cm	1	1	55.00	49.50	44.00
204 24 20	Pfeffermühle, H: 20 cm	1	1	55.00	49.50	44.00

Salz- und Pfeffermühlen Peugeot Fidji

CNS/Buchenholz, in der Farbe Kirschbaum, andere Grössen auf Anfrage



		Pièce		1	6	12
204 18 12	Salzmühle, 12 cm Ø	6	1	34.00	30.60	27.20
204 19 12	Pfeffermühle, 12 cm Ø	6	1	34.00	30.60	27.20

Pfeffermühlen Peugeot

Die bekannten Pfeffermühlen von Peugeot aus Eichenholz



		Pièce		1	6	12
200 32 12	H: 12 cm, 5.3 cm Ø	1	1	32.00	24.00	25.00
200 32 18	H: 18 cm, 5.5 cm Ø	1	1	39.00	29.25	30.00
200 32 22	H: 22 cm, 5.9 cm Ø	1	1	44.00	33.00	35.00
200 32 30	H: 30 cm, 6.8 cm Ø	1	1	62.00	46.50	50.00

Öl-/Essig Menage



		Pièce		1	12	30
200 12 25	Rotonda, 25 cl, H: 11.7 cm, 8.5 cm Ø	1	1	9.90	8.91	7.92
200 13 25	Conica, 25 cl, H: 15.3 cm, 9.1 cm Ø	1	1	9.90	8.91	7.92

Öl-/Essig-Ausgiesser

Aus CNS und Silikonkork. Mit patentiertem Rückflusssystem bleibt die Flasche sauber



		Pièce		1	10	30
310 43 00	für Öl	1	1	4.80	4.32	10.00
310 44 00	für Essig	1	1	4.80	4.32	10.00

Zuckerdosierer



		Pièce		1	10	30
200 38 00	Giesser, H: 12.5 cm, 6.8 cm Ø	1	1	5.70	5.42	5.13

Service

Öl-/Aceto Flaschen Premium

Mit Ausgiesser CNS 18/8 und Silikonkork

25 cl, H: 19.5 cm, 7 x 5 cm

		Stück	1	12	36
				10 %	20 %
200 19 25	OLIVE OIL, 25 cl, H: 19.5 cm, 7 x 5 cm	12	1	6.00	5.40 4.80
200 19 26	ACETO VINEGAR, 25 cl, H: 19.5 cm, 7 x 5 cm	12	1	6.00	5.40 4.80



Öl-/Aceto Flaschen Precious

Mit Ausgiesser CNS 18/8 und Silikonkork

Cooler Design im Metall-Look

25 cl, H: 19.5 cm, 7 x 5 cm

		Stück	1	12	36
				10 %	20 %
200 23 25	OLIVE OIL, 25 cl, H: 19.5 cm, 7 x 5 cm	6	1	9.60	8.64 7.68
200 23 26	ACETO VINEGAR, 25 cl, H: 19.5 cm, 7 x 5 cm	6	1	9.60	8.64 7.68



Smart Bag CHIC small

Sie sind neu, sie sind trendy und sie sind praktisch dazu – die neuen Smart Bag. Präsentieren Sie Salz- und Pfeffermühlen auf ganz neue, unkonventionelle Weise. Die stylischen Smart Bags small sehen toll aus und werden Ihre Gäste begeistern. Sie sind praktisch, der Tisch bleibt sauber, ohne Salz- und Pfefferrückstände. Aus Kunstleder, braun, abwaschbar. Ohne Inhalt

		Stück	1	12	36
				29.00	20 %
201 05 85	Smart Bag, 12 x 8, H: 12.5 cm	1	1	29.00	23.20
		Stück			30 %
200 57 14	Salzmühle, H: 12.5 cm	4	1	49.90	13.93
200 56 14	Pfeffermühle, H: 12.5 cm	4	1	49.90	13.93



Smart Bag CHIC medium

Die stylischen Smart Bags sehen toll aus und werden Ihre Gäste begeistern. Aus Kunstleder, braun, abwaschbar. Ohne Inhalt

		Stück	1	12	36
				33.50	20 %
201 06 85	Smart Bag, 17 x 9.5, H: 18 cm	1	1	33.50	26.80

Small-Tablett CHIC

Das Small-Tablett CHIC ist komplett mit braunem Kunstleder bezogen und zeichnet sich durch seinen vielseitigen Verwendungszweck aus

		Stück	1	12	36
				22.00	20 %
281 88 85	20 x 10 cm, H: 2 cm	1	1	22.00	17.60



Naturschieferplatte

Mit 2 Vertiefungen 6 cm Ø, ohne Mühlen

Nicht spülmaschinengeeignet

		Stück	1	12	36
				10 %	20 %
252 27 15	Naturschieferplatte, 15 x 8 cm	1	1	5.50	4.95 4.40
		Stück			20 %
200 76 17	Salzmühle, H: 16.5 cm	4	1	45.92	15.92
200 75 17	Pfeffermühle, H: 16.5 cm	4	1	45.92	15.92





Paperbags

Robustes Kraftpapier

			Stück	1	12	30
211 30 17	sand, 17 cm Ø	1	1	10.60	9.54	8.48
211 30 20	sand, 20 cm Ø	1	1	12.20	10.98	9.76
211 30 24	sand, 24 cm Ø	1	1	18.70	16.83	14.96
211 34 17	schwarz, 17 cm Ø	1	1	10.60	9.54	8.48
211 34 20	schwarz, 20 cm Ø	1	1	12.20	10.98	9.76
211 34 24	schwarz, 24 cm Ø	1	1	18.70	16.83	14.96

Brot Bags mit Kuhflecken

Brot Bag im coolen Kuh-Look

Aus PVC, abwaschbar

Kann auf beide Seiten verwendet werden



			Stück	1	12	30
211 31 15	15 cm Ø, H: 12 cm	1	1	26.00		20.80
211 31 20	20 cm Ø, H: 15 cm	1	1	33.00		26.40

Brot Bags sand

Stoff-Brot-Bag aus Baumwolle, bis 30° waschbar



			Stück	1	12	30
211 26 17	rund, 17 cm Ø, H: 8 cm	1	1	11.00	9.90	8.80
211 26 20	rund, 20 cm Ø, H: 9 cm	1	1	12.00	10.80	9.60
211 26 15	oval, 20 x 15 cm, H: 7 cm	1	1	11.00	9.90	8.80
211 26 18	oval, 25 x 18 cm, H: 9 cm	1	1	13.00	11.70	10.40

Brot Bags schwarz/sand

Stoff-Brot-Bag aus Baumwolle, bis 30° waschbar



			Stück	1	12	30
211 28 17	rund, 17 cm Ø, H: 8 cm	1	1	11.00	9.90	8.80
211 28 20	rund, 20 cm Ø, H: 9 cm	1	1	12.00	10.80	9.60
211 28 15	oval, 20 x 15 cm, H: 7 cm	1	1	12.00	10.80	9.60
211 28 18	oval, 25 x 18 cm, H: 9 cm	1	1	13.00	11.70	10.40

Bambus-Körbchen

Bambusgeflecht natur



			Stück	1	12	30
211 03 22	rund, 22 cm Ø, H: 7.5 cm	1	1	1.90	1.62	1.33
211 04 23	oval, 23 x 16 cm, H: 6.5 cm	1	1	1.80	1.53	1.26

Brot-Körbchen

Vollweide



			Stück	1	12	30
211 00 19	rund, 19 cm Ø, H: 7 cm	1	1	5.10	4.85	4.59
211 01 29	oval, 29 x 21 cm, H: 7 cm	1	1	10.80	10.26	9.72

Poly-Rattan-Körbe

Kunststoffgeflecht, hygienisch, lebensmittelecht, leichte Reinigung



			Stück	1	12	30
211 05 20	rund, 20 cm Ø, H: 7 cm	1	1	5.30	4.77	4.24
211 08 23	rund, 23 cm Ø, H: 8 cm	1	1	5.50	4.95	4.40
211 05 22	oval, 23 x 10 cm, H: 6 cm	1	1	4.70	4.23	3.76
211 05 23	oval, 23 x 15 cm, H: 6.5 cm	1	1	4.90	4.41	3.92

Service

Polyester-Körbe

Kunststoffgeflecht, hygienisch, lebensmittelecht, leichte Reinigung

		Stück	1	12	30	
				10 %	20 %	
211 40 81	naturfarbe, rund, 21 cm Ø, H: 8 cm	6	1	5.90	5.31	4.72
211 40 85	braun, rund, 21 cm Ø, H: 8 cm	6	1	5.90	5.31	4.72
211 40 99	schwarz, rund, 21 cm Ø, H: 8 cm	6	1	5.90	5.31	4.72
211 41 81	naturfarbe, oval, 24 x 16 cm, H: 8 cm	6	1	6.70	6.03	5.36
211 41 85	braun, oval, 24 x 16 cm, H: 8 cm	6	1	6.70	6.03	5.36
211 41 99	schwarz, oval, 24 x 16 cm, 8 cm Ø	6	1	6.70	6.03	5.36



ab
4.72

Rattan-Körbe

Rattangeflecht mit verchromtem Drahtgestell, stabile Ausführung, stapelbar

		Stück	1	12	30	
				10 %	20 %	
211 06 22	rechteckig, 22 x 15 cm, H: 5.5 cm	1	1	7.90	7.11	6.32
211 06 25*	rund, 25.5 cm Ø, H: 5 cm	1	1	11.40	10.26	9.12
211 06 29*	oval, 29 x 14 cm, H: 6 cm	1	1	11.40	10.26	9.12



Edelstahlschalen

CNS 18/8, exklusives Design

		Stück	1	12	30	
				10 %	20 %	
211 24 20	oval, 20 x 14 cm, H: 4.5 cm	1	1	24.90	22.41	19.92



Brot-/Früchte-Körbe

CNS 18/10 poliert, spülmaschinenfest

		Stück	1	12	30	
				10 %	20 %	
211 21 17	rund, 17.5 cm Ø, H: 7.5 cm	1	1	16.00	14.40	12.80
211 21 21	rund, 20.5 cm Ø, H: 8.5 cm	1	1	25.00	22.50	20.00
211 21 25	rund, 25.5 cm Ø, H: 9.5 cm	1	1	25.00	22.50	20.00
211 21 20	oval, 20 x 15 cm, H: 7 cm	1	1	18.00	16.20	14.40
211 21 28	oval, 28 x 21 cm, H: 9.5 cm	1	1	25.00	22.50	20.00



Körbchen Chromstahl

Mit eingerolltem Rand, spülmaschinenfest, für Pouletpapier 465 00 32

		Stück	1	12	30	
				10 %	20 %	
211 20 26	oval, 26 x 18.5 cm, H: 4 cm	1	1	13.00	11.70	10.40
211 20 31	oval, 31 x 21 cm, H: 4.5 cm	1	1	15.90	14.31	12.72



Brot-/Früchte-Körbe

CNS poliert, mit Hammerschlag Optik

		Stück	1	12	30	
				10 %	20 %	
211 27 16	rund, 16 cm Ø, H: 5 cm	1	1	5.80	5.22	4.64
211 27 20	rund, 20 cm Ø, H: 5.5 cm	1	1	9.70	8.73	7.76



Brot-/Früchte-Körbe Stripes

CNS 18/8, aussen hochglanzpoliert, innen matt

		Stück	1	12	30	
				10 %	20 %	
211 27 16	rund, 17 cm Ø, H: 5 cm	1	1	17.00	15.30	13.60
211 27 20	rund, 20 cm Ø, H: 6 cm	1	1	24.00	21.60	19.20



NEW



Poly-Rattan-Körbe GN 1/3, GN 1/2 und GN 1/1

Kunststoffgeflecht, hygienisch, lebensmittelecht, leichte Reinigung, stabile Ausführung mit Edelstahlhdraht im Rand, spülmaschinengeeignet

		Stück	1	12	30
211 09 13	GN: 1/3, 32.5 x 17.5 cm, H: 6.5 cm	1	1	16.00	12.80
211 15 13	GN: 1/3, 32.5 x 17.5 cm, H: 10 cm	1	1	20.00	16.00
211 09 12	GN: 1/2, 32.5 x 26.5 cm, H: 6.5 cm	1	1	20.00	16.00
211 15 12	GN: 1/2, 32.5 x 26.5 cm, H: 10 cm	1	1	25.00	20.00
211 09 11	GN: 1/1, 53 x 32.5 cm, H: 6.5 cm	1	1	32.00	25.60
211 15 11	GN: 1/1, 53 x 32.5 cm, H: 10 cm	1	1	38.00	30.40



Poly-Rattan-Körbe GN 1/3, GN 1/2 und GN 1/1

Kunststoffgeflecht, hygienisch, lebensmittelecht, leichte Reinigung, stabile Ausführung mit Edelstahlhdraht im Rand, spülmaschinengeeignet

		Stück	1	12	30
211 16 13	GN: 1/3, 32.5 x 17.5 cm, H: 10 cm	1	1	18.00	14.40
211 16 12	GN: 1/2, 32.5 x 26.5 cm, H: 10 cm	1	1	24.00	19.20
211 16 11	GN: 1/1, 53 x 32.5 cm, H: 10 cm	1	1	38.00	30.40



Poly-Rattan-Körbe GN 1/2 und GN 1/1

Kunststoffgeflecht, hygienisch, lebensmittelecht, spülmaschinengeeignet

		Stück	1
211 05 32	GN 1/2, 32.5 x 25.5 cm, H: 8 cm	1	17.00
211 05 53	GN 1/1, 53 x 32.5 cm, H: 9.5 cm	1	40.00



Brot-Bufferkörbe

Rattan-Korb

		Stück	1
211 14 44	Brotkorb rund, 44 cm Ø, H: 13 cm	1	62.80
211 14 45	Rolltopphaube SAN rund, 41 cm Ø	1	57.80
211 14 50	Brotkorb rechteckig, 50 x 29.5 cm, H: 14.5 cm	1	61.30
211 14 51	Rolltopphaube SAN rechteckig, 47 x 27 cm	1	52.00



Brot-Servierkörbe

Für Brote, Früchte etc. Vollweide, lackiert

		Stück	1
211 11 37	37 x 27 cm, H: 8 cm	1	14.00
211 12 39	39 x 50 cm, H: 11/19 cm	1	78.00



Brot-Servicekörbe

Vollweide

		Stück	1
211 18 45	45 x 45 cm, H: 15/25 cm	1	38.40



Brot-Präsentierkörbe

Für Brote, Früchte etc. Vollweide, lackiert

		Stück	1
211 10 42	42 cm Ø, H: 14 cm	1	26.95
211 10 51	51 cm Ø, H: 15 cm	1	34.65

Service

Gebäck- und Tortenglocken

Glasklar

		Stück			
460 35 28	Glocke klar, 28 cm Ø, H: 10 cm	1	1		11.90
460 35 33	Glocke klar, 33 cm Ø, H: 12 cm	1	1		18.00



Gebäck- und Tortenplatte

Platte aus Edelstahl, inkl. Deckel aus PS

		Stück			
460 39 38	für Torten bis 32, H: 12 cm	1	1	40.00	32.00



Brosamenschaber

Für einen sauberen und gepflegten Tisch

		Stück	1	12	30
201 10 00	14 x 2.7 cm	1	1	6.90	6.21
201 10 01*	Mit Hohlgriff, 22 x 6.5 cm	1	1	25.00	22.50



Brötchen-/Sandwich-Box

Mit Scharnier-Klarsichthaube, beidseitig zu öffnen

		Stück			
210 00 00	39 x 26 cm, H: 17 cm	1	1	49.00	31.85
210 00 01	47 x 31.5 cm, H: 19.5 cm	1	1	89.00	57.85



Gebäckbeutel

Kreuzbodenbeutel glasklar, reissfest, 40 my

		Stück	1	6	12
460 40 24	20 x 29 cm	1	500 100 =	59.80 11.96	56.81 11.36



Brotbrett

Endlich keine Brosamen mehr auf dem Buffet und Boden! Massiv, aus gedämpfter Buche, mit grossen Schlitzten, Auffangschale aus weissem Luran

		Stück			
211 30 00	44 x 30 cm,	1	1	86.00	68.80
211 30 10	Brotbrett mit Messer	1	1	94.90	75.92



Brotbrett

Inkl. Melamin-Tablett mit Antirutschfüsschen, 59.5 x 35.5 cm, H: 3.5

		Stück			
211 29 00	Brotschneidebrett, 52 x 34 cm	1	1	97.50	78.00



Brotmesser/Konditorsäge

Edelstahl, rostfrei

		Stück			
410 07 21	Brotmesser, 21 cm	1	1	42.00	10.80
410 06 26	Konditorsäge, 5.5 cm	1	1	37.00	33.30





hulu Aluminium-Tischsteller

Aluminium eloxiert, 4 mm dick, sehr stabil und nicht biegsam, mit beidseitiger schwarzer Gravur. Bitte geben Sie bei der Bestellung die gewünschten Nummern bekannt. Jeder Tischsteller wird einzeln von Hand graviert. Der ausgewiesene Preis entspricht einem gravierten Tischsteller / Stückpreis.

		Stück	1	12	30
202 01 50	No 1 - 50, 6 cm	1	1	14.00	13.30
202 01 51	No 51 - 99, 6 cm	1	1	14.00	13.30



Tischnummern CNS

Chromnickelstahl 18/8 - nummeriert

		Stück	1	12	30
202 02 12	5.2 cm, H: 4,2 cm, No 1 - 12	1	12	26.90	26.90
202 02 24	5.2 cm, H: 4,2 cm, No 13 - 24	1	12	26.90	26.90
202 02 36	5.2 cm, H: 4,2 cm, No 25 - 36	1	12	26.90	26.90
202 02 48	5 cm, H: 4 cm, No 37 - 48	1	12	26.90	26.90
202 02 60	5 cm, H: 4 cm, No 49 - 60	1	12	26.90	26.90
202 02 72	5 cm, H: 4 cm, No 61 - 72	1	12	26.90	26.90



Tischsteller CNS

CNS 18/8

		Stück	1	12	30
202 07 00	Nichtraucher, 5.5 x 5 cm, H: 3.5 cm	1	1	5.00	2.50
202 15 00	Reserviert Kt. à 2 Stück, 5.5 x 5 cm, H: 3.5 cm	1	2	15.00	10.50



Kartenhalter-Klammer Set

2 Holzklammer inkl. 30 Beschriftungskarten (15 x weiss, 15 x schwarz, ca. 10 x 8 cm)

		Stück	1	12	30
202 19 00	Set à 2, 4 x 2.5 cm, H: 10 cm	1	2	20.00	16.00



Buffet-Schild CNS

		Stück	1	12	30
202 02 00	Kt. à 3 Stück, 13 x 7 cm	1	3	24.00	22.80



Kartenhalter 18-teilig

6 Halter, Metall hartverchromt, 3.8 x 2.5 cm, H: 2 cm
12 Beschriftungskarten aus Kunststoff, 10 x 5.7 cm

		Stück	1	12	30
202 16 00	Set à 6	1	6	20.00	18.00



Kartenhalter

Kartenhalter können flach und hoch aufgestellt werden, mit Magnetverschluss, inkl. 40 Beschriftungskarten

		Stück	1	12	30
202 18 00	Set à 2, 9 x 3 cm, H: 5.5 cm	1	2	26.00	20.80

Kartenhalter mit Klemme

		Stück	1	30	60	
				5 %	10 %	
202 12 01	Kunststoff-Sockel, H: 12 cm	4	1	9.00	8.55	8.10
202 12 10	Edelstahl, H: 10.5 cm	4	1	9.00	8.55	8.10

Schilderhalter Flexibel

biegsam mit zwei Klemmen, für die Anbringung an Schüsseln, Körben und Theken

		Stück	1	30	60
				20 %	
202 17 12	Schilderhalter, 12 cm	1	1	6.70	5.36
202 17 22	Schilderhalter, 22 cm	1	1	9.00	7.20
202 17 50	Schilderkarten, 5 x 3 cm	1	10	8.30	6.64
202 17 51	Schilderkarten, 8 x 5 cm	1	10	9.00	7.20



Reklame-Tischsteller

Transparent

		Stück	1	30	60	
				5 %	10 %	
203 03 00	10 x 6 cm	1	1	2.20	2.09	1.98
203 03 01	A5, 10.5 x 15 cm	1	1	2.40	2.28	2.16



Dreieck-Tischständer Acryl

Zum Einschieben von Reklameblättern, transparent, antireflex

		Stück	1	30	60	
				5 %	10 %	
203 04 00	A6, H: 14.8 cm, 9.5 cm Ø	1	1	9.50	9.03	8.55
203 04 01	A5, H: 21 cm, 13.5 cm Ø	1	1	10.50	9.98	9.45



Tischständer Acryl

		Stück	1	30	60	
				10 %	20 %	
203 05 00	A6, 15.5 x 10.6 cm	1	1	7.80	7.02	6.24
203 05 01	A5, 21.8 x 15 cm	1	1	12.00	10.80	9.60
203 05 02	A4, 30.9 x 21.1 cm	1	1	19.00	17.10	15.20



hulu KaRe-Kartenhalter

Kartenhalter und Reklameständer in einem! Als Kartenhalter (für Karten bis 13 mm Dicke) sowie als Reklameständer (zum Einschieben von 4 Reklamekärtchen). So präsentieren Sie jederzeit Ihre Aktualitäten. Aus Acrylglas

		Stück	1	30	60	
				10 %	20 %	
203 00 00	10 x 8 cm, H: 10 cm	1	1	13.50	12.15	10.80



Kartenhalter

		Stück	1	12	30	
				5 %	10 %	
203 02 00	CNS 18/10, 8 x 7 cm, H: 2 cm	1	1	6.90	6.56	6.21





hulu Mini-Kreidentafelständer

Der auffallende Kreidentafelständer für Aktionen, Hits, Tagesangebote, Wein des Monats, Reserviert für... etc. Mit Kreidentafel (fix befestigt) und Dreibein-Ständer, Buchenholz lackiert

		Stück		1
202 10 00	Tafel mit Ständer, H: 24 cm, 15 x 13 cm	3	1	49.80 13.86 30 %



Neon-Boardmarker edding

Neon-Boardmarker mit Keilspitze ist ideal zum Schreiben und Markieren auf dunklen Tafeln und anderen glatten Oberflächen z.B. Glas und Whiteboards. Die Tinte ist trocken abwaschbar. Die Farbsättigung kann durch eine Beleuchtung der beschrifteten Tafel intensiviert werden. Die Tinte ist schnelltrocknend, geruchsarm, wasserlöslich, lichtbeständig und schnell trocken und sorgt für schattenfreie Reinigung
Strichbreite 2-5 mm

		Stück		1
202 93 00	weiss	1	1	8.50
202 93 15	neongelb	1	1	8.50
202 93 35	neonpink	1	1	8.50
202 93 55	neongrün	1	1	8.50



Windowmarker edding

Flüssig-Kreide zum Beschriften von Schiefertafeln, Glas, etc., feucht abwischbar, 2-5 mm

		Stück		1
202 90 00	weiss	1	1	6.90
202 90 45	rot	1	1	6.90
202 90 55	grün	1	1	6.90
202 90 65	blau	1	1	6.90
202 90 99	schwarz	1	1	6.90



Kreidemarker Deco Graph edding

Flüssig-Kreide zum Beschriften von Schiefertafeln, Glas etc., feucht abwischbar, bis 15 mm

		Stück		1
350 60 00	weiss	1	1	11.50
350 60 15	gelb	1	1	11.50
350 60 25	orange	1	1	11.50
350 60 35	pink	1	1	11.50
350 60 50	hellgrün	1	1	11.50
350 60 65	blau	1	1	11.50
350 60 99	schwarz	1	1	11.50



Windows-Kreidemarker Securit

Flüssig-Kreide zum Beschriften von Schiefertafeln, Glas etc., feucht abwischbar, bis 6 mm

		Stück		1
202 91 00*	4 Stück in den Farben weiss	1	4	19.90 <small>4.98</small>
202 91 01*	4 Stück in den Farben blau, rot, grün, gelb	1	4	19.90



Windows-Kreidemarker Securit

Flüssig-Kreide zum Beschriften von Schiefertafeln, Glas etc., feucht abwischbar, 7-15 mm

		Stück		1
202 92 00*	4 Stück in den Farben weiss	1	4	36.00 <small>9.00</small>
202 92 01*	4 Stück in den Farben blau, rot, grün, gelb	1	4	36.00

Service

Kreidetafel Table Top

Echtholz-Rahmen lackiert, beidseitig beschreibbar

		Stück		1
				30 %
351 00 25	A5, 21 x 15 cm	1	1	20.00 14.00



Tafeln Bistro

Echtholz lackiert, zum Hängen längs und quer, auch ideal für den Verkauf am Tisch

		Stück		1
				30 %
351 00 15	47 x 60 cm	1	1	60.00 42.00
351 00 16	47 x 79 cm	1	1	65.00 45.50
351 00 17	60 x 87 cm	1	1	74.00 51.80



Tafel Stukkato

Rahmen Echtholz mit Dekor, lackiert, zum Hängen längs und quer

		Stück		1
				30 %
351 00 20	65 x 92 cm	1	1	179.00 125.30



Kreidetafel-Ständer Basic

Klappbare Tafel aus Kunststoff mit Echtholz-Rahmen lackiert, einseitig beschreibbar, für den Innenbereich

		Stück		1
				30 %
351 00 08	120 x 65 cm	1	1	135.00 94.50



Kreidetafel-Ständer Performance

Klappbare Tafel aus Kunststoff mit Echtholz-Rahmen lackiert, beidseitig beschreibbar, für den Innen- und Aussenbereich, bedingt witterungsbeständig

		Stück		1
				30 %
351 00 05	118 x 61 cm	1	1	265.00 185.50

Kreidetafel-Ständer X-tras

Extra schwere, klappbare Tafel aus Kunststoff mit Echtholz-Rahmen lackiert, beidseitig beschreibbar, für den Innen- und Aussenbereich, bedingt witterungsbeständig

		Stück		1
				30 %
351 00 00	120 x 65 cm, 18 kg	1	1	999.00 279.30





premiStar



Kreidetafeln

Robuste Kreidetafel für Aktionen, Hits, Tagesangebote, Wein des Monats etc., Kunstharz-kompaktplatte

		Stück		
202 10 50	Kreidetafel, 18 x 14 cm	1	1	9.80
350 82 53	Kreidetafel, 78.5 x 59 cm	1	1	65.00
350 82 50	Kreidetafel A1, 83.7 x 59 cm	1	1	68.50
350 82 51	Kreidetafel, 130 x 64.5 cm	1	1	98.00
350 82 52	Kreidetafel, 164.5 x 43 cm	1	1	93.50



premiStar

hulu Reklame-Tafel

Rahmen Buche natur, lackiert, schwarz beidseitig beschriftbar, mit Kreidetafel, für Wandbefestigung oder Dreibein-Ständer

		Stück		
350 55 00	82 x 50 cm	1	1	139.00 83.40
350 56 00	100 x 73 cm	1	1	265.00 159.00



premiStar

Staffelei- und Tafelständer

Tafelständer ohne Tafeln

		Stück		
350 57 00*	Dreibein, Buche natur, für Art. 3505500 / 3505600, H: 136 cm, B x T: 76 x 68 cm, T: 68 cm	1	1	129.00 77.40



premiStar

Staffelei verstellbar

Buche gebeizt, lackiert, einfaches Anpassen für verschiedene Kreidetafelgrößen

		Stück		
351 00 24	80 x 54 cm, H: 178/250 cm	1	1	150.00 105.00

Service

Plakatständer

Mit transparenter Schutzfolie, beidseitig verwendbar

		Stück			
350 81 00	Alu Profil mit Klapprahmen, Grösse A1	1	1	360.00	198.00 45 %
350 81 50	Aufsatzschild Polystrol weiss	1	1		46.70
350 81 51	Aufsatzschild-Halterung	1	1		26.80
350 82 00	Alu mit Klapprahmen inkl. 2 Kreidetafeln, Grösse A1	1	1	395.00	316.00 20 %
350 82 50	Kreidetafel schwarz, Grösse A1, 83.7 x 59 cm	1	1		68.50



Anschlagrahmen Acryl

Aus Acrylglas für Zimmerhinweise, Werbung etc. Transparent mit weissem Rahmen, selbstklebend. Für Einschub A4.

		Stück	1	12	30
350 71 01	Grösse A4, 32 x 25.2 cm	1	1	28.00	25.20 10 % 22.40 20 %



Anschlagrahmen Alu

Für die Hygiene-Kontrolle der Toiletten, als Infoboard, mit durchsichtiger Plexiglas-Platte, Hoch- oder Querformat, Rahmen Aluminium, farblos eloxiert

		Stück			
350 70 00	Grösse A5, 22 x 15.3 cm	1	1	139.00	111.20 20 %
350 70 01	Grösse A4, 22 x 30.3 cm	1	1	149.00	119.20



Epsilon Alu-Klapprahmen

Das geniale Klick-Klack-System für das einfache Wechseln von Informationen, matt-silber eloxiert

		Stück			
350 65 01	Grösse A4, 21 x 29.7 cm	1	1	48.00	36.00 25 %
350 65 02	Grösse A3, 29.7 x 42 cm	1	1	60.00	45.00
350 65 03*	Grösse A2, 42 x 59.4 cm	1	1	75.00	52.50



hulu Kreidetafel

Alu-Rahmen silber eloxiert, mit Kreidetafel für Wandbefestigung oder Dreibein-Ständer

		Stück			
350 61 80	Silber, Grösse: 80 x 60 cm	1	1		94.00



Menü- und Weinkarten

Menü- und Weinkarten mit Ihrem Logo oder individuellem Schriftzug sind bereits ab kleiner Stückzahl erhältlich. Ihre unverbindliche Anfrage freut uns.

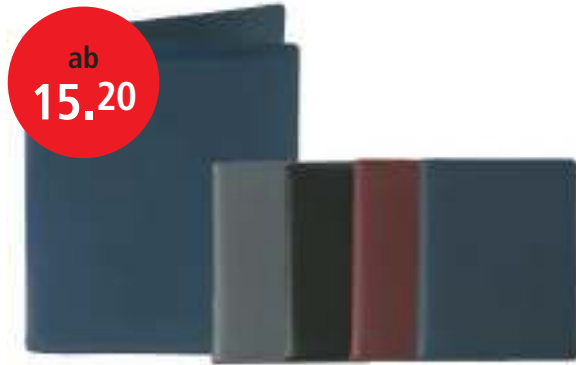

Menükarten Classic Style

Luxuriös verarbeitete Buchbinderschrauben-Mappen in hochwertigem Kunstleder
Ohne Innenhüllen (max. 10 Sichthüllen = 20 Seiten)

Können nur mit Einsteckhüllen transparent 232 12 29 bestückt werden

		Stück	1	20	60
232 14 48	Für A4, 29.7 x 21 cm, bordeaux	1	1	19.00	17.10
232 14 65	Für A4, 29.7 x 21 cm, blau	1	1	19.00	17.10
232 14 95	Für A4, 29.7 x 21 cm, grau	1	1	19.00	17.10
232 14 99	Für A4, 29.7 x 21 cm, schwarz	1	1	19.00	17.10
		Stück	1	5	10
232 12 29	Einsteckhüllen A4, 29.7 x 21 cm	1	100	53.00	47.70



Menükarten Canvas

Schöne, geschmackvolle und feuchtigkeitsbeständige Mappen aus Leinen mit Buchschrauben

Ohne Innenhüllen (max. 6 Passepartout = 12 Seiten, 6 Passepartout de Luxe = 12 Seiten oder 9 Sichthüllen = 18 Seiten)

		Stück	1	20	60
232 00 48	Für A4, 29.7 x 21 cm, bordeaux	1	1	32.00	28.80
232 00 99	Für A4, 29.7 x 21 cm, schwarz	1	1	32.00	28.80
232 01 48	Für A4C, 21 x 21 cm, bordeaux	1	1	27.00	24.30
232 01 99	Für A4C, 21 x 21 cm, schwarz	1	1	27.00	24.30



Menükarten Style

Elegante und edle Mappen in Vinylausführung mit Fasermotiv und mit Buchschrauben

Ohne Innenhüllen (max. 6 Passepartout = 12 Seiten, 6 Passepartout de Luxe = 12 Seiten oder 9 Sichthüllen = 18 Seiten)

		Stück	1	20	60
232 02 17	Für A4, 29.7 x 21 cm, gold	1	1	26.00	23.40
232 02 39	Für A4, 29.7 x 21 cm, silber-aubergine	1	1	26.00	23.40
232 02 48	Für A4, 29.7 x 21 cm, rot	1	1	26.00	23.40
232 02 65	Für A4, 29.7 x 21 cm, blau	1	1	26.00	23.40
232 03 17	Für A4C, 21 x 21 cm, gold	1	1	21.00	18.90
232 03 39	Für A4C, 21 x 21 cm, silber-aubergine	1	1	21.00	18.90
232 03 48	Für A4C, 21 x 21 cm, rot	1	1	21.00	18.90
232 03 65	Für A4C, 21 x 21 cm, blau	1	1	21.00	18.90



Menükarten Library Holz

Tolle Mappen in Holzoptik - natürlicher Look - mit Buchschrauben. In Esche hell und Eiche dunkel erhältlich

Ohne Innenhüllen (max. 6 Passepartout = 12 Seiten, 6 Passepartout de Luxe = 12 Seiten oder 9 Sichthüllen = 18 Seiten)

		Stück	1	20	60
232 04 80	Für A4, 29.7 x 21 cm, Esche-hell	1	1	35.00	31.50
232 04 89	Für A4, 29.7 x 21 cm, Eiche-dunkel	1	1	35.00	31.50

Service

Klemm-Menükarten

Die Menüblätter werden von einer praktischen Klemmschiene gehalten. Ihr Speisen- und Getränkeangebot können Sie jederzeit einfach, flexibel und individuell anpassen. Der Umschlag dieser Klemmkarten zeichnet sich durch schön verarbeitete Kanten und knickfeste Randbereiche aus. Das Cover aus Vinyl erfüllt die Ansprüche in der Gastronomie und lässt sich leicht reinigen.

Verleihen Sie der Karte Ihre persönliche Note. Die edlen und zugleich robusten Einbände bringen Ihr Logo besonders gut zur Geltung und verbildlichen den Anspruch Ihres Hauses an Qualität und Stil.

Nehmen Sie mit uns Kontakt auf. Gerne unterbreiten wir Ihnen ein ansprechendes Angebot.



		Stück	1	20	60
232 17 02	Für A4, 29.7 x 21 cm, écru	1	1	69.00	55.20
232 17 86	Für A4, 29.7 x 21 cm, rehbraun	1	1	69.00	55.20
232 17 93	Für A4, 29.7 x 21 cm, granit	1	1	69.00	55.20

Passepartout de Luxe A4

Für 2 Seiten

		Stück	1	20	60
232 09 02	crème	2	1	5.30	4.77



Passepartouts A4/A4C

Plastifiziert

		Stück	1	20	60
232 08 03	A4, 29.7 x 21 cm, crème	2	1	4.00	3.60
232 08 48	A4, 29.7 x 21 cm, bordeaux	2	1	4.00	3.60
232 08 65	A4, 29.7 x 21 cm, blau	2	1	4.00	3.60
232 08 99	A4, 29.7 x 21 cm, schwarz	2	1	4.00	3.60
232 13 48	A4C, 21 x 21 cm, bordeaux	2	1	3.80	3.42
232 13 65	A4C, 21 x 21 cm, blau	2	1	3.80	3.42
232 13 99	A4C, 21 x 21 cm, schwarz	2	1	3.80	3.42



Einsteckhüllen transparent

		Stück	1	5	10
232 12 29	Einsteckhüllen A4, 29.7 x 21 cm	1	100	53.00	47.70
232 12 21	Einsteckhüllen A4C, 21 x 21 cm	1	100	49.00	44.10



Clipboards Choice

Trendiges und stabiles Clipboard in Holzoptik mit starker Edelstahl Federkammer. Ob als Bar-, Menü- und Weinkarte oder Rechnungbringer, das Clipboard ist überall einsetzbar

		Stück	1	6	12
232 21 27	Bill presenter, 26.5 x 11.5 cm	6	1	8.50	7.65
232 21 33	Für A4, 33 x 23 cm	6	1	16.50	14.85





Magnet Menükarten A4

Schützt Ihre Menükarte, in edlem matt schimmernden Seidenlook. Die magnetischen Seitenklappen geben den perfekten Halt.

		Stück	1	10	30
232 20 85	Für A4, 33 x 21.5 cm, bronze	10	1	18.50	16.65
232 20 99	Für A4, 33 x 21.5 cm, schwarz	10	1	18.50	16.65



Getränke- und Menükarten Universal

Speisekarten "american style", mit Stepprand, transparent, zweiteilig oder dreiteilig mit 4 Eckenverzierungen

		Stück	1		1
232 11 02	für 4 Seiten, 2 Teile, A4, 29.7 x 21 cm	10	1	26.00	15.60
232 11 03	für 6 Seiten, 3 Teile, A4, 29.7 x 21 cm	10	1	36.00	21.60
232 11 13	für 6 Seiten, 3 Teile, A4 schmal, 29.7 x 13.5 cm	10	1	32.00	19.20



Menükartenhalter

Der originelle Getränke- und Menükartenhalter, Holz natur, für A4-Zeigetaschen, Befestigung mit Buchschrauben

		Stück	1		1
230 60 00	Menükartenhalter, 41.5 cm	1	1	19.80	15.84
231 00 00	Zeigetaschen A4, extra stark	1	1	1.60	1.52



Zeigetaschen

		Stück	1	50	100
231 10 01	Grösse A4, 80my, glatt	1	100		11.00
231 00 00	Grösse A4, extra stark, matt	1	1	1.60	1.52



Menükarten-Papier

Chamois, 210 x 297 mm, 110 g/m2

		Stück	1	6	12
231 61 03	A4, beidseitig marmoriert	1	300	124.80	118.56
			100 =	41.60	39.52
					112.32
					37.44



Menükarten-Clips

Clips aus Kunststoff, selbstklebend, zum Befestigen von Zetteln, Karten, auf der Speisekarte, an Türen und Wänden

		Stück	1	6	12
231 25 00	45 x 13 mm	1	100	25.00	23.75

Service

Fotokopierpapier

Holzfrei, 210 x 297 mm, 80 g/m²

		Stück	1	5	25
231 50 00	A4, weiss	1	500 100 =	8.50 1.70	7.65 1.53
					6.80 1.36
					10 % 20 %



Rechnungstablett

Edelstahltablett 18/0 hochglanzpoliert, inkl. 1 klappbare Ledermappe mit Stiftflasche und Magnethalterung

		Stück	1	30	60
231 32 00	20 x 16 cm	1	1	38.00	30.40
					20 %



Rechnungsmappe Chic

Edle Rechnungsmappe mit eingelassenem Münzfach in dunkelbraunem Kunstleder

		Stück	1	30	60
231 33 85	14 x 24.5 cm	1	1	37.00	29.60
					20 %



29.60

Menükarten Elite

Wunderschöne, elegante und qualitativ sehr hochwertige Menükarte mit Aufdruck MENU. Mit Kordel und einer Doppelhülle A4. Zusätzliche Doppelhüllen möglich

		Stück	1	30	60
230 35 48*	bordeaux	1	1	39.80	27.86
230 35 51*	lindengrün	1	1	39.80	27.86
230 35 84*	hellbraun	1	1	39.80	27.86
230 35 99*	schwarz	1	1	39.80	27.86
230 36 00*	kork	1	1	48.90	34.23



		Stück	1	30	60
230 71 00	Doppelhüllen	1	1	2.10	2.00
					5 % 10 %

Weinkarte Elite

Strukturaufdruck einer Weinflasche/einem Glas, mit Kordel, mit einer Doppelhülle A4. Zusätzliche Doppelhüllen möglich

		Stück	1	30	60
230 33 00	kork	1	1	47.00	37.60
230 33 99	schwarz	1	1	39.80	31.84



		Stück	1	30	60
230 71 00	Doppelhüllen	1	1	2.10	2.00
					5 % 10 %

ab
77.-



Kerzenständer San Remo

		Stück		1	
220 30 38	5-armig, vernickelt, H: 52 cm	1	1	110.00	77.00 30 %
220 30 52	5-armig, vernickelt, H: 52 cm	1	1	140.00	98.00
220 30 78	5-armig, vernickelt, H: 78 cm	1	1	220.00	154.00
220 30 11	5-armig, vernickelt, H: 106 cm	1	1	420.00	294.00

TOP



Kerzenständer Kupfer-Look

Kerzenständer Kupfer-Look mit extra schwerem Fuss, Metall hartverchromt, mit möbelschonender Filzunterseite

		Stück		1	
220 83 11	Kupfer, H: 11 cm	1	1	24.00	19.20 20 %
220 83 16	Kupfer, H: 16 cm	1	1	28.00	22.40
220 83 22	Kupfer, 22 cm Ø	1	1	31.00	24.80



Kerzenmanschetten

Tropfenfänger zur Vermeidung lästiger Wachsplecken

		Stück	1	20	40
220 25 10	10 cm Ø	1	100	17.00 10 %	13.60 20 %



Spitzkerzen 20 cm

Mit Hartwachsmantel - weitgehend tropffrei

		Stück	1	6	30
220 00 00	weiss	1	24 1 = 0.62	15.00 14.25 0.59	13.50 10 % 0.56
220 00 45	rot	1	24	15.00	13.32
220 00 48	bordeaux	1	24	15.00	13.50



Spitzkerzen 24 cm

Mit Hartwachsmantel - weitgehend tropffrei

		Stück	1	6	30
220 12 00	weiss	1	50 1 = 0.61	32.00 30.40 0.61	28.80 10 % 0.58
220 12 02	champagne	1	50	32.00	28.80
220 12 15	gelb	1	50	32.00	28.80
220 12 45	rot	1	50	32.00	28.80
220 12 48	bordeaux	1	50	32.00	28.80
220 11 85*	braun	1	10 1 = 0.39	3.90 3.71 0.37	3.51 0.35

Windlicht Cylindro

Edelstahl matt poliert, Gläser satiniert, mit möbelschonender Filzunterseite

Fuss wird nicht heiss, keine Verbrennungsgefahr

	Stück	1			6			12		
		1	2	12.40	11.7	10 %	11.7	20 %	10.4	
220 94 15 Set à 2, H: 15 cm, 5 cm Ø	1	2	26.00	23.40	20.80					



Windlicht Flame

Edelstahl matt poliert, Gläser satiniert, mit möbelschonender Filzunterseite.

Fuss wird nicht heiss, keine Verbrennungsgefahr

	Stück	1			6			12		
		1	2	18.50	18.45	10 %	16.4	20 %	16.4	
220 52 12 Set à 2, H: 12.4 cm, 7.5 cm Ø	1	2	41.00	36.90	32.80					



Ausziehbares-Feuerzeug

	Stück	1			1		
		1	1	15.00	12.00 <td></td> <td></td>		
250 91 00* 9/13.5 cm	1	1					



Paraffin-Lampenöl

	Stück	1		
		1	1	69.00
220 50 00 Paraffin-Lampenöl, 24 x 19.5 cm, H: 36 cm, 12 l	1	1		



Rechaudkerzen mit Blechhülsen

	Stück	1			6			12		
		1	800	59.00	56.05	53.10	5 %	10 %		
220 29 03 Budget-Qualität, nicht für Réchauds geeignet	1	800	59.00	56.05	53.10					
220 27 00 Hotel-Qualität	1	1200	171.00	162.45	153.90					
220 28 00 Hotel-Qualität	1	100								



Rechaudkerzen Jumbo mit Blechhülsen

Extra lange Brenndauer von ca. 7.5 Std.

	Stück	1			12			30		
		1 <th>180 <th>43.00</th> <th>40.85</th> <th>38.70</th> <th>5 %</th> <th>10 %</th> </th>	180 <th>43.00</th> <th>40.85</th> <th>38.70</th> <th>5 %</th> <th>10 %</th>	43.00	40.85	38.70	5 %	10 %		
220 32 01 Hotel-Qualität	1	180	43.00	40.85	38.70					



Rechaudkerzen Maxi mit Blechhülsen

Extra lange Brenndauer von ca. 10 Std.

	Stück	1			12			30		
		1 <th>216 <th>117.00</th> <th>111.15</th> <th>105.30</th> <th>5 %</th> <th>10 %</th> </th>	216 <th>117.00</th> <th>111.15</th> <th>105.30</th> <th>5 %</th> <th>10 %</th>	117.00	111.15	105.30	5 %	10 %		
220 33 02 6 cm Ø	1	216	117.00	111.15	105.30					



ab
3,36



Teelichter

	Stück	1	30	60
220 58 00 Buzz, H: 7.5 cm, 6.5 cm Ø	6	1	4.20	3.78
				3.36

Teelichter



	Stück	1	36	72
178 00 11 Atoll, H: 5.5 cm, 6.3 cm Ø	6	1	2.20	1.98
				1.76
171 23 04 Turku, H: 100 mm, 93 mm Ø	6	1	2.80	2.52
				2.24

Windlichter Votiv Scita

Die edlen und mundgeblasenen Windlichter ZWIESEL 1872 sorgen für stimmungsvolle Momente



	Stück	1	12	24
220 65 00* weiss, 8.4 cm Ø, H: 7.5 cm	1	1	21.30	19.17
220 65 16 bernstein, 8.4 cm Ø, H: 7.5 cm	1	1	24.00	21.60
220 65 53 oliv, 8.4 cm Ø, H: 7.5 cm	1	1	21.30	19.17
220 65 75 purple, 8.4 cm Ø, H: 7.5 cm	1	1	21.30	19.17

20%



Robert Welch

Teelicht Molton Robert Welch

CNS 18/10

	Stück	1	12	24
220 71 12 H: 11.5 cm	1	1	34.70	27.76

Teelichter Sesame Robert Welch

CNS 18/10



Robert Welch

	Stück	1	12	24
220 70 08 H: 8 cm, 5.5 cm Ø	1	1	28.20	22.56
220 70 13 H: 9 cm, 12.5 cm Ø	1	1	52.90	42.32

TOP





Windlicht Alabaster

Aus Alabaster in Handarbeit gefertigt sind diese wundervollen Windlichter. Sie verbreiten ein schönes, weiches Licht und schaffen ein einmaliges Ambiente.

Jedes Stück ist von Hand gearbeitet und hat deshalb auch seine eigene Struktur und kann in Farbe und Grösse leicht variieren. Für Innen- und Aussenbereich

Windlicht Alabaster Round

ca. 8 cm Ø, H: ca. 9 cm

	Stück	1	12	24
220 66 09	6	1	19.80	17.82 10 %
				14.85 25 %



premio *Star*

Windlicht Alabaster Square

8 x 8 cm, H: ca. 9 cm

	Stück	1	12	24
220 66 08	6	1	19.80	17.82 10 %
				14.85 25 %



premio *Star*



Windlichter Agnes

Zaubern Sie ein stimmungsvolles Ambiente mit diesen formschönen Glas-Windlichtern. Passend dazu gibt es die Flüssigwachs-Einsätze. Sehr lange Brenndauer, keine Wachs-rückstände



		Stück	1	12	24	
220 61 00	clear cracle, 7.6 cm Ø, H: 9.5 cm	12	1	16.20	14.58	12.96
220 61 01	satin weiss, 7.6 cm Ø, H: 9.5 cm	12	1	13.00	11.70	10.40
220 61 02	amber, 7.6 cm Ø, H: 9.5 cm	12	1	21.40	19.26	17.12
220 61 45	dunkelrot, 7.6 cm Ø, H: 9.5 cm	12	1	21.40	19.26	17.12
220 62 15	Flüssigwachs Kerzen, Brenndauer 15 h, 4.5 cm Ø	1	96	174.10	156.69	139.28
			1 =	1.68	1.63	1.45
220 62 26	Flüssigwachs Kerzen, Brenndauer 26 h, 5.2 cm Ø	1	60	159.80	143.82	127.84
			1 =	2.47	2.39	2.13

Windlichter Anna

Passend dazu gibt es die Flüssigwachs-Einsätze. Sehr lange Brenndauer, keine Wachs-rückstände



		Stück	1	12	24	
220 60 00	clear cracle, 7.6 cm Ø, H: 9.5 cm	12	1	16.20	14.58	12.96
220 60 01	satin weiss, 7.6 cm Ø, H: 9.5 cm	12	1	13.00	11.70	10.40
220 60 02	amber, 7.6 cm Ø, H: 9.5 cm	12	1	13.00	11.70	10.40
220 60 46	dunkelrot, 7.6 cm Ø, H: 9.5 cm	12	1	13.00	11.70	10.40
220 62 15	Flüssigwachs Kerzen, Brenndauer 15 h, 4.5 cm Ø	1	96	174.10	156.69	139.28
			1 =	1.68	1.63	1.45



Flüssigwachs Kerzen

		Stück	1	12	24	
220 62 15	Flüssigwachs Kerzen, Brenndauer 15 h, 4.5 cm Ø	1	96	174.10	156.69	139.28
			1 =	1.68	1.63	1.45
220 62 26	Flüssigwachs Kerzen, Brenndauer 26 h, 5.2 cm Ø	1	60	159.80	143.82	127.84
			1 =	2.47	2.39	2.12



Kerzotron-Kartuschen / Kerzenmäntel 60/10

Kerzotron-Einsätze für beide Grössen

		Stück	1	3	6	
221 32 06	Brenndauer 60 h, 220 ml, 5.7 cm Ø, H: 11.5 cm	1	24	154.00	138.60	123.20
			1 =	6.42	5.78	5.14
221 32 10	Brenndauer 100 h, 265 ml, 5.7 cm Ø, H: 15 cm	1	24	219.00	197.10	175.20
			1 =	9.13	8.22	7.30
		Stück	1		1	
221 31 45	rot	1	1	7.80	6.24	
221 31 18	honig	1	1	7.80	6.24	
221 31 00	weiss	1	1	7.80	6.24	
221 31 35	rosa	1	1	7.80	6.24	

Service

Zylinderkerzen weiss

		Stück	1	12	30
220 13 00	4 x 8 cm, Brenndauer ca. 12h	1	24	26.00	20.80
					20 %
220 14 00	5 x 11.5 cm, Brenndauer ca. 20h	1	24	30.75	24.60
					40 %



Zylinderkerzen

Mit Hartwachsmantel - weitgehend tropffrei

		Stück	1	12	30
220 23 55*	smaragdgrün, 10 x 4 cm	1	50	36.50	29.20
					20 %
220 21 45*	rot, 11.5 x 5 cm	1	24	37.50	30.00
					40 %



Vasen

		Stück	1	60	120
201 20 00	Bouquet, Vase aus Glas, 6.8 cm Ø, H: 15 cm	1	1	3.60	3.24
					10 %
201 21 00	Fiore, Porzellan, 7 cm Ø, H: 14 cm	1	1	7.50	6.75
					10 %



ab
2.88

Frühstücks-/ Tischabfall-Behälter

Ornamin, stapelbar

		Stück	1	12	30
201 00 00	Uni weiss, H: 13 cm, 10.5 cm Ø	1	1	5.10	4.85
					5 %
					10 %



Frühstücks-/ Tischabfall-Behälter Edelstahl

		Stück	1	12	30
201 03 00	mit Wippdeckel, Edelstahl gebürstet, H: 17 cm, 12 cm Ø	1	1	25.00	23.75
					5 %
201 04 00	offen, Edelstahl 18/8, mattiert, H: 18 cm, 10 cm Ø	1	1	33.00	31.35
					5 %





Aschenbecher Glas

		Stück	1	6	12
225 04 07	Bistro, Klarglas, 7.2 cm Ø	1 24 1 =	23.80 0.92	21.42 0.89	19.04 0.79
225 01 10	Klarglas, 10 cm Ø	1 6 1 =	10.80 1.65	9.72 1.62	8.64 1.44
225 02 10	Rauchglas, 10 cm Ø	1 6 1 =	12.30 2.05	11.07 1.85	9.84 1.64
225 05 14	Doppelrand, Klarglas, 13 cm Ø	1 1	1.90	1.71	1.52



Wind-Aschenbecher Porzellan

		Stück	1	6	12
225 21 11	11.5 cm Ø, H: 5.5 cm	1 6 1 =	55.00 9.17	49.50 8.25	44.00 7.34



Wind-Aschenbecher Melamin

Stapelbar, 10 cm Ø, Höhe 4 cm

		Stück	1	12	30
225 44 00	weiss, 10 cm Ø	1 1	6.60	5.94	5.28
225 44 99	schwarz, 10 cm Ø	1 1	6.60	5.94	5.28



Aschenbecher Kunststoff

		Stück	1	12	30
225 30 10	schwarz, 10 cm Ø, H: 4.5 cm	1 1	6.50	6.18	5.85
225 41 99	Windascher schwarz, 10 cm Ø, H: 4 cm	1 1	9.90	9.41	8.91



Aschenbecher CNS

		Stück	1	12	30
225 31 16	Eco, 16 cm Ø	1 1	6.90		4.14
225 32 11	Windaschenbecher, 11 cm Ø, H: 3.5 cm	1 1	11.90	11.31	10.71
225 32 12	Windaschenbecher mit Schutzdeckel, 11.5 cm Ø, H: 5.5 cm	1 1	15.00		13.50



Aschenbecher schwer CNS

CNS 18/8, hochwertige, schwere Ausführung

		Stück	1	10	20
225 42 08	8 cm Ø, H: 3 cm	1 1	13.00		7.80
225 36 12*	12 cm Ø, H: 3 cm	1 1	17.80		10.68



Ascherpinsel

		Stück	1	10	20
225 45 00	22.5 cm	1 1	3.90	3.71	3.51

Wind-Aschenbecher Glas

Metall verchromt, Glas gefrostet, mit Bajonettverschluss

		Stück	1	12	30
				10 %	20 %
255 47 00	weiss, 9.5 cm Ø, H: 8 cm	1	13.00	11.70	10.40
255 47 15	gelb 9.5 cm Ø, H: 8 cm	1	13.00	11.70	10.40
255 47 56	türkis, 9.5 cm Ø, H: 8 cm	1	13.00	11.70	10.40
255 47 99	schwarz, 9.5 cm Ø, H: 8 cm	1	13.00	11.70	10.40
255 48 58	dunkelgrün, 9.5 cm Ø, H: 8 cm	1	11.80	10.62	9.44
255 48 76	aubergine, 9.5 cm Ø, H: 8 cm	1	11.80	10.62	9.44



Wand-Aschenbecher

		Stück	1	12	30
				10 %	20 %
225 38 00*	CNS 18/10, kippbar, einfach zu leeren, 14.5 x 10.5 cm	1	1	58.00	29.00
				10 %	20 %
225 39 00	Aluminium, eloxiert, 12 cm Ø, H: 16.5 cm	1	1	59.80	53.82



Abfalleimer mit Schwingdeckel

Aus Edelstahl, Innenbehälter Stahlblech, verzinkt, herausnehmbar, für ein einfaches Entleeren und eine optimale Reinigung

		Stück	1	12	30
				10 %	20 %
225 55 50	50 l, 35 cm Ø, H: 75 cm	1	1		170.00



Standascher/Abfallbehälter

CNS, herausnehmbarer Aschereinsatz und verzinkter Innenbehälter

		Stück	1	12	30
				10 %	20 %
740 09 72	Standascher CNS, H: 72 cm, 30 cm Ø	1	1	489.00	151.20
740 05 62	CNS poliert, H: 62 cm, 30 cm Ø	1	1	86.00	68.80
				10 %	20 %
740 00 61	Druck-Standaschenbecher CNS, H: 61 cm, 14.5 cm Ø	1	1		62.00



Aschenbecher CNS

		Stück	1	12	30
				10 %	20 %
740 08 00	Wand-Ascher, H: 53 cm, 6 cm Ø	1	1	498.00	158.40
740 08 10	Standaschenbecher, Sockel 27 cm Ø, H: 100 cm, 6 cm Ø	1	1	249.00	199.20
				10 %	20 %
740 07 10	Smokers Point, H: 86 cm, 9 cm Ø, Fuss 24x24 cm	1	1	204.00	153.00



Flambi-Spiess®

Druck Ihres Namens

Spiess-Varianten
direkt an Ihrem
Tisch flambiert!



Das exklusive Gourmet-Erlebnis

Restaurant Muster, Musterstrasse 1, 6000 Luzern, 000 555 55 55

Flambi-Spiess Set® die Erfolgsgeschichte!

Das exklusive Gaumenerlebnis - direkt am Tisch flambiert. Der Ganz-Jahres-Hit - schnell und einfach zubereitet (mit dem Show-Effekt). Einmal etwas anderes als winterliche Hits wie Fondue, Raclette etc., ohne Geruchsemission

Den Flambi-Spiess® erhalten Sie exklusiv für Ihren Ort ab 20 Sets. Sind Sie interessiert? Dann rufen Sie uns an. Wir beraten Sie gerne und sagen Ihnen, ob der Flambi-Spiess® in Ihrem Ort noch nicht vergeben ist. Design brunelli

Das Flambi-Spiess®-Set besteht aus:

- Casserole 29 cm Ø, 3-Schichtmaterial aus Edelstahl mit vergoldeten Griffen, mit der Patentlösung des aufsetzbaren Flambi-Kelches mit Spiesshalterung
 - Spiess 31 cm, aus CNS mit Messinggriff
 - Warmhalte-Rechaud Rondo
 - Scarpe-Teller aus Porzellan
 - Mit folgendem Werbematerial: 10 Menukartenhalter und 2 Zeigetaschen mit 10 Flambi-Spiess®-Titelseiten mit Ihrem Namen, 4-farbig A4, 90 Flambi-Spiess®-Fotodrucke mit 9 verschiedenen Flambi-Spiess®-Varianten
 - 1 Bilderrahmen Alu mit Flambi-Spiess®-Poster und Ihrem Namen
- Rezeptideen und Gebrauchsanweisung sowie CD für Inserate/Internet etc.

Flambi-Spiess Set®

		Stück		1
240 00 00	1 Set komplett	1	1	275.00 220.00



Profi Küchenbrenner CNS 18/10

Bis zu 2 Stunden Non Stop Brenndauer. Perfekt geeignet für Crèmes Brûlée, Tarte Tatin usw. Funktioniert mit Feuerzeuggas. Fassungsvermögen 28 ml, wird ungefüllt geliefert

		Stück		1
250 92 00	0.28 l, H: 16.5 cm	1	1	57.00 39.90



Flambierpfanne Profi de Luxe

Edelstahl 18/10, in schwerer Ausführung, hochwertiges 3-Schicht-Material aus Kupfer, Aluminium

		Stück		1
400 94 28	28 cm Ø, H: 5 cm	1	1	196.00 156.80





Adventure Gamelle

Stahl, schwarz für Fondue, Pasta, Chili con Carne etc.
4-teilig: Gamelle beschichtet, Rechaud, Fonduegabel, Pastenbrenner

		Stück	1	6	12
241 20 00	24 x 19.5 cm, H: 15 cm	1	1	29.00	27.55
					26.10



Fondue-Caqueleons Hit

Gusseisen, emailliert

		Stück	1	12	24
241 65 20	20 cm Ø, 2-3 Personen	1	1	49.80	47.31
241 65 22	22 cm Ø, 4 Personen	1	1	54.80	52.06



Fondue-Caqueleons Lux

Gusseisen, emailliert

		Stück	1	12	24
241 58 48	21 cm Ø, 3 - 4 Personen	1	1	59.00	47.20
241 59 48	23 cm Ø, 5 - 6 Personen	1	1	69.00	55.20



Fondue-Caqueleons Nero

Gusseisen schwarz matt, emailliert

		Stück	1	12	24
241 66 18	18 cm Ø, 1-2 Personen	1	1	42.00	37.80
241 66 20	20 cm Ø, 3 - 4 Personen	1	1	59.00	53.10
241 66 22	22 cm Ø, 5 - 6 Personen	1	1	69.00	62.10



Fondue-Caqueleons Alpes

Gusseisen, emailliert
schwarz/crèmes, Dekor weiss

		Stück	1	12	24
241 15 21	21 cm Ø, 3 - 4 Personen	1	1	85.00	68.00
241 15 23	23 cm Ø, 5 - 6 Personen	1	1	89.00	71.20



Fondue Rechaud Alpes

Mit Sockel aus Naturholz und Brennpasten-Brenner

		Stück	1	6	12
241 16 00	Rechaud, 21 cm Ø	1	1	49.00	46.55



Windschutzrechaud

Ideal zum Benützen des Rechauds auf der Terrasse oder im Garten, inklusive Brennpasten-brenner

		Stück	1	6	12
241 19 00	20 cm Ø, H: 11 cm	1	1	38.00	36.10



Windschutz für Rechaud

Windschutz schwarz/weiss, für alle Rechauds bis Ø 23 cm geeignet. Ideal zum Benützen des Rechauds auf der Terrasse oder im Garten

		Stück	1	12
241 18 00	23 cm Ø	1	1	22.00

Service

Käsefondue-Gabeln

Rostfrei, Griffe Nylon

		Stück	1	12	24
					10 %
241 57 00	28 cm, 3 Zacken, schwarz	1	6	24.50	22.05
241 17 00	28 cm, 3 Zacken, Dekor Alpes	1	6	38.00	34.20



Fleischfondue-Gabeln

Rostfrei, Griffe Nylon

		Stück	1	12	24
					10 %
241 21 00	26 cm, 2 Zacken, schwarz	1	6	24.50	22.05



Kartoffelsack Karo

19 x 21 cm, 100 % Baumwolle, waschbar bis 30°

		Stück	1	12	24
					10 %
241 77 00	rot/weiss kariert	1	1	13.50	12.15
					20 %
					10.80



Brot Bag Karo

Stoff-Brot-Bag aus Baumwolle, bis 30° waschbar

		Stück	1	12	24
					10 %
211 32 17	rot, rund, 17 cm Ø, H: 8 cm	1	1	11.00	9.90
211 33 17	blau, rund, 17 cm Ø, H: 8 cm	1	1	11.00	9.90
					20 %
					8.80



Brot Bag mit Kuhflecken

Brot Bag im coolen Kuh-Look

Aus PVC, abwaschbar, Kann auf beide Seiten verwendet werden

		Stück	1	12	24
					10 %
211 31 15	15 cm Ø, H: 12 cm	1	1	26.00	20.80
211 31 20	20 cm Ø, H: 15 cm	1	1	33.00	26.40
					20 %
					20.80



Gratin-/Eierplatte aus Gusseisen Suisse

mit Bambusbrett

		Stück	1	12	30
					10 %
132 53 18	18 cm Ø, mit Griff 24 cm Ø	1	1	39.00	35.10



Valais-Teller

Porzellan, für Fondues Chinoise oder Bourguignonne etc.

		Stück	1	12	30
					10 %
131 27 00	oval, 28 x 24 cm	6	1	15.00	13.50
					20 %
					12.00



Fondue-Teller

Für Fondue Chinoise oder Bourguignonne etc.

		Stück	1	12	30
					10 %
131 28 00	Porzellan, 23 cm Ø	6	1	13.50	9.45
131 28 28	Porzellan, 27.5 cm Ø	4	1	21.50	15.05
					30 %
					9.45





Caquelons Bourguignonne CNS

		Stück	1	6	12
241 10 00	Classic, 1,8 l	1	59.00	53.10	47.20
241 11 00	Swiss Eco, 2 l	1	69.00	62.10	55.20



Brenner CNS

		Stück	1	6	12
241 54 00	Pastenbrenner, 8,5 cm Ø	1	1	9.90	
241 49 00	Gasbrenner, 7,5 cm Ø	1	1	44.90	



Fondue Rechaud

Mit Rechauduntersatz und Brennpasten-Brenner

		Stück	1	6	12
241 51 00	Basic, verchromt, 18 cm Ø, H: 10 cm	1	1	29.80	28.31
					26.82
241 12 00	Lux, verchromt, 20 cm Ø, H: 9.5 cm	1	1	59.00	53.10
					47.20



Fondue Rechaud Rustic

Für Käse- und Fleischfondues mit Unterteller und Brennpasten-Brenner

		Stück	1	6	12
241 50 00	23 cm Ø, H: 11 cm	1	1	36.50	34.68
					32.85



Alu Rondelle

Hitzeverteiler aus Aluminium für Fondue-Rechaud. Ermöglicht eine gleichmässige Hitzeverteilung auf dem Caquelonboden und verhindert somit ein Anbrennen des Fondues

		Stück	1	6	12
241 56 02	15.5 cm Ø	1	1	5.90	



Raclette-Apparat Super

Käsetradition aus dem Wallis. Die Portionen werden direkt vom halben Laib in den Teller gestrichen. Durch die patentierte Hebe-, Senk- und Kippvorrichtung ist der Raclette-Käse optimal an der Hitzequelle. Für 2 halbe Laib Raclette-Käse, Grundplatte aus Alu-Guss und Naturstein, 1 Heizkörper 1000 W, ca. 150 Portionen pro Stunde

		Stück	1	6	12
241 71 00	52 x 28 cm, H: 33 cm, 12 kg	1	1	425.00	382.50



Raclette-Apparat Brio Gas

Der Gasbetrieb erlaubt das Schmelzen von Raclette-Käse im Freien, mit Infrarotstrahlen, unabhängig von Elektrizität oder Holzfeuer. Durch die patentierte Hebe-, Senk- und Kippvorrichtung ist der Raclettekäse optimal an der Hitzequelle. Für 2 halbe Laib Raclette-Käse, Grundplatte aus Alu-Guss und Naturstein, Heizleistung 2600 - 3400 Watt, ca. 150 Portionen pro Std. Gerät nur mit Druckregler verwenden!

		Stück	1	6	12
241 72 00	52 x 28 cm, H: 33 cm, 14 kg	1	1	740.00	666.00

Andere Modelle auf Anfrage

Rechaud mit 8 Warmhalteplatten

- Gehäuse aus Aluminium
- mit 8 Warmhalteplatten aus Aluminium
- Plattenmaß: 280 x 165 mm
- Temperaturregler stufenlos
- Ein-/Aus Schalter mit integrierter Kontrolleuchte (rot)
- rutschfeste Stellfüsse

		Stück	1	12	30
241 89 08	38 x 25 cm, H: 44.7 cm, 1250 W, 230 V, 22.7 kg	1	1	1060.00	



Plattenwärmer stapelbar

Stapelbar, Eisendraht 5 mm Ø, verchromt, Design brunelli

		Stück	1	12	30
241 80 00	30 x 18 cm, H: 7.5 cm	1	1	19.50	17.55 15.60
241 82 00	Ersatz-Kerzennäpfe CNS	1	1	4.60	4.14 3.68



Plattenwärmer Re-Design

Stahl verzinkt und verchromt, Seiten aus Kunststoff, Deckgitter Stahl verchromt, stapelbar, abnehmbares Gitter, doppelwandige Kerzenhalter, eingebaute von aussen bedienbare Kerzenlöschvorrichtung

		Stück	1	12	30
241 86 99	1 Kerze, schwarz matt, 21 x 19 cm	1	1	29.90	26.91
241 87 99	2 Kerzen, schwarz matt, 36 x 19 cm	1	1	39.90	35.91
241 86 90	1 Kerze, chrom matt, 21 x 19 cm	1	1	29.90	26.91
241 87 90	2 Kerzen, chrom matt, 36 x 19 cm	1	1	39.90	35.91



Rechaud mit Aluminium-Wärmeplatte

Unterteil CNS 18/8, Wärmeplatte aus Aluminium zur guten Wärmeverteilung, für 2 Rechaudkerzen

		Stück	1	12	30
241 85 00	33 x 18 cm	1	1	63.00	44.10



Rechaud Rondo

Mit Alu-Wärmeplatte für Servierpfannen, Teller, Saucen, Buffets etc., Gestell verchromt, CNS-Kerzennäpfe für 2 Rechaudkerzen für noch mehr Wärme, Design brunelli

		Stück	1	12	30
240 11 00	25 cm Ø, H: 6 cm	1	1	48.00	43.20 38.40



Rechaudkerzen mit Blechhülsen

		Stück	1	6	12
220 29 03	Budget-Qualität, nicht für Rechauds geeignet	1	800	59.00	56.05 53.10
220 27 00	Hotel-Qualität	1	1200 1000 =	171.00 138.33	162.45 135.38 153.90 128.25
220 28 00	Hotel-Qualität	1	100		14.80



Rechaudkerzen Jumbo mit Blechhülsen

Extra lange Brenndauer von ca. 7.5 Std.

		Stück	1	12	30
220 32 01	Hotel-Qualität	1	180	43.00	40.85 38.70



Polyester-Tabletts für den professionellen Einsatz

Erste Qualität zum besten Preis dank Generalimport



Özay-Polyester-Tabletts

SMC glasfaserverstärkte Polyester-Tabletts - geeignet für die hohe Beanspruchung in Kliniken, Heimen, Self-Service und in der Gastronomie. Die Tabletts sind spülmaschinenfest und haben einen erhöhten, extra verstärkten Rand. Sie wurden für automatische Abstapelvorrichtungen entwickelt.

Weitere Vorteile:

- Gute Belüftung, Trocknung und Abkühlung durch Distanznocken
 - Hohe Kantenfestigkeit durch speziell verstärkte Aussenränder und Kanten
 - Schlag- und kratzfest, bruchstabil, temperaturbeständig von -10 bis + 140°
 - Säure- und laugenbeständig
 - Besonders geeignet für vollautomatische Transportanlagen
- Farbe: Grau granit

		Stück		1
281 00 93	Oval, 29 x 21 cm	1	1	5.90 4.72
281 01 93	GN: 1/2, 32.5 x 26.5 cm	1	1	11.00 8.80
281 06 93	42.5 x 32.5 cm	1	1	15.00 12.00
281 03 93	46 x 36 cm	1	1	17.40 13.92
281 04 93	GN: 1/1, 53 x 32.5 cm	1	1	17.70 14.16
281 05 93	Euronorm, 53 x 37 cm	1	1	19.80 15.84

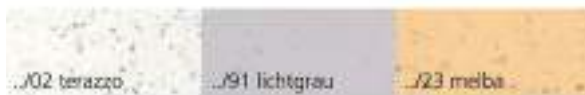

Özay-Polyester-Tabletts Sonderfarben

Lieferbar auf Bestellung ab 120 Stk., Aufpreis 10 %



Özay-Polyester-Tabletts

Mit Werbedruck ab 120 Stück

Die ideale Werbefläche auf dem Tablett! Aufpreis für Fotodruck/Zeichnung ab Ihren digitalen Druckdaten.

Lieferfrist 8 - 10 Wochen ab Gut zum Druck

		Stück		1
281 39 00	Aufpreis Fotodruck/Zeichnung	1	1	4.20



Özay-Polyester-Antirutsch-Tabletts

Rutschfest - Ob trocken oder nass!

SMC glasfaserverstärkte Polyester-Tabletts mit Kautschuk-Antirutsch-Belag für eine hohe Beanspruchung in der Gastronomie. Die Tabletts haben einen verstärkten Rand und sind spülmaschinengeeignet.

Farben: Grau granit oder schwarz

		Stück		1
281 10 95	grau, 29 x 21 cm, Oval	1	1	9.30 7.44
281 11 95	grau, 32 cm Ø, Rand cm: 3.5	1	1	20.00 16.00
281 12 95	grau, 36 cm Ø, Rand cm: 3.8	1	1	21.40 17.12
281 13 95	grau, 32.5 x 26.5 cm, GN: 1/2	1	1	16.60 13.28
281 15 95	grau, 46 x 36 cm	1	1	26.50 21.20
281 16 95	grau, 53 x 32.5 cm, GN: 1/1	1	1	26.60 21.28
281 17 95	grau, 53 x 37 cm, Euronorm	1	1	30.90 24.72
281 11 99	schwarz, 32 cm Ø, Rand cm: 3.5	1	1	20.00 16.00
281 12 99	schwarz, 36 cm Ø, Rand cm: 3.8	1	1	21.40 17.12
281 13 99	schwarz, 32.5 x 26.5 cm, GN: 1/2	1	1	16.60 13.28
281 15 99	schwarz, 46 x 36 cm	1	1	26.50 21.20
281 16 99	schwarz, 53 x 32.5 cm, GN: 1/1	1	1	26.60 21.28

Service

Selform-Antirutsch-Tabletts Holzoptik

Die neuen Tabletts in Eiche-Holzoptik beweisen, dass Serviertabletts auch schön und repräsentativ aussehen können! Der Holz-Look gibt den Tabletts eine natürliche Note. Aus Laminat mit rutschfester Oberfläche. Eignen sich hervorragend für den Self-Service, Restaurants, Cafés, Bars, Bergrestaurants, Gaststätten, Brauereien etc.

- Leicht und stark
- Nicht spülmaschinenfest
- Schlagfest
- Temperaturbeständig von -10 bis +100°C

		Stück		1	20 %
281 09 83	Eiche hell, 32.5 x 26.5 cm, GN: 1/2	1	1	14.80	11.84
281 09 85	Eiche braun, 32.5 x 26.5 cm, GN: 1/2	1	1	14.80	11.84
281 09 89	Eiche dunkel, 32.5 x 26.5 cm, GN: 1/2	1	1	14.80	11.84
281 14 83	Eiche hell, 53 x 32.5 cm, GN: 1/1	1	1	23.50	18.80
281 14 85	Eiche braun, 53 x 32.5 cm, GN: 1/1	1	1	23.50	18.80
281 14 89	Eiche dunkel, 53 x 32.5 cm, GN: 1/1	1	1	23.50	18.80



Özay-Özaytread-Antirutsch-Tabletts

Rutschfest
Polyester-Tabletts mit Kautschuk-Antirutsch-Beschichtung

		Stück		1	20 %
281 60 99	28 cm Ø	1	1	36.40	21.84
281 61 99	35 cm Ø	1	1	46.00	27.60
281 62 99	41 cm Ø	1	1	53.00	31.80
		Stück		1	20 %
281 63 99	45 cm Ø	1	1	38.30	30.64
281 64 99	68 x 56 cm, Oval	1	1	76.60	61.28
281 65 99	53 x 37 cm, Euronorm	1	1	40.20	32.16



ab
21.84



Özay-Rubberform-Antirutsch-Tabletts

Laminat-Schichtstoff-Tabletts mit Kautschuk-Beschichtung, schwarz

		Stück		1	20 %
281 20 99	32 cm Ø	1	1	22.40	17.92
281 21 99	38 cm Ø	1	1	26.60	21.28
281 26 99	26.5 x 20 cm, Oval	1	1	12.80	10.24
281 23 99	43 x 33 cm	1	1	26.40	21.12
281 29 99	53 x 32.5 cm, GN: 1/1	1	1	31.10	24.88



Antirutsch-Tabletts

schwarz, mit Metallverstärkung

		1	12	24
281 91 35	35.5 cm Ø	1	23.20	22.04
281 91 41	41 cm Ø	1	30.60	29.07



NEW

ab
10.80



Trend-Tablets

Hochwertige und trendige Laminat-Schichtstoff-Tablets mit strukturierter Oberfläche
 - Leicht und stark
 - Spülmaschinenfest
 - Schlag- und kratzfest
 - Temperaturbeständig von -10 bis +100°C
 - Säure- und laugenbeständig

		Stück		1
281 07 89	wenge, 24 x 35 cm	1	1	13.50 10.80 20 %
281 07 91	hellgrau, 24 x 35 cm	1	1	13.50 10.80
281 07 93	granit, 24 x 35 cm	1	1	13.50 10.80
281 08 89	wenge, 53 x 37 cm, Euronorm	1	1	22.20 17.76
281 08 91	hellgrau, 53 x 37 cm, Euronorm	1	1	22.20 17.76
281 08 93	granit, 37 x 53 cm, Euronorm	1	1	22.20 17.76



Selform-Tabletts

Hochwertige Laminat-Schichtstoff-Tablets mit Holzdekor
 - Leicht und stark
 - Spülmaschinenfest
 - Schlag- und kratzfest
 - Temperaturbeständig von -10 bis +100°C
 - Säure- und laugenbeständig

		Stück	1	60	120
281 40 87	23 x 16 cm, Oval	1	1	5.00	4.50
281 41 87	26.5 x 20 cm, Oval	1	1	5.90	5.31
281 42 87	29 x 21 cm, Oval	1	1	7.40	6.66
281 43 87	32.5 x 26.5 cm, GN: 1/2	1	1	9.40	8.46
281 45 87	53 x 32.5 cm, GN: 1/1	1	1	15.80	14.22

Andere Farben ab 500 Stk



Selform-Antirutsch-Tabletts

Hochwertige Laminat-Schichtstoff-Tablets mit rutschfester Oberfläche
 - Leicht und stark
 - Nicht spülmaschinenfest
 - Schlagfest
 - Temperaturbeständig von -10 bis +100°C

		Stück	1	60	120
281 50 87	23 x 16 cm, Oval	1	1	7.60	6.84
281 51 87	26.5 x 20 cm, Oval	1	1	7.80	7.02
281 52 87	29 x 21 cm, Oval	1	1	10.10	9.09
281 53 87	32.5 x 26.5 cm, GN: 1/2	1	1	13.50	12.15
281 54 87	43 x 33 cm	1	1	18.50	16.65
281 55 87	53 x 32.5 cm, GN: 1/1	1	1	22.10	19.89

Andere Farben ab 500 Stk



Selform-Werbe-Tabletts

Der ideale Werbeträger auf Ihrem Tablett! Aufpreis für Fotodruck/Zeichnung ab Ihren digitalen Druckdaten. Lieferfrist 8 - 12 Wochen ab Gut zum Druck

		Stück	1	
281 39 00	Aufpreis Fotodruck/Zeichnung	1	1	4.20

Service

Serviertablett Holz

	Stück			1
282 13 26 26 x 16 cm, H: 2 cm, schwarz	1	1	14.90	11.92 20 %



Serviertablett CHIC

Serviertablett in Kunstleder, Kroko-Optik braun, antirutsch

	Stück			1
281 80 00 36 x 22.5 cm, Kroko braun	1	1	46.00	36.80 20 %
281 81 00 Kroko braun, 52 x 35 cm	1	1	62.00	49.60



Serviertablett CHIC

Holztablett mit dunkelbraunem Kunstleder, antirutsch

	Stück			1
281 82 85 braun, 25 x 25 cm	1	1	43.60	34.88 20 %
281 83 85 braun, 28 x 16 cm	1	1	38.00	30.40
281 84 85 braun, 53 x 16 cm	1	1	60.00	48.00
281 85 85 braun, 42.5 x 32.5 cm	1	1	59.00	47.20



Serviertablett CHIC

Holztablett mit schwarzem Kunstleder, antirutsch

	Stück			1
281 82 99 schwarz, 25 x 25 cm	1	1	43.60	34.88 20 %
281 83 99 schwarz, 28 x 16 cm	1	1	38.00	30.40
281 84 99 schwarz, 53 x 16 cm	1	1	60.00	48.00
281 85 99 schwarz, 42.5 x 32.5 cm	1	1	59.00	47.20



Serviertablett CHIC

Serviertablett in Kunstleder, Kroko-Optik

	Stück			1
281 86 99 Kroko schwarz, 41 x 26 cm	1	1	69.50	55.60 20 %



Melamintablett mit Holzoptik

	Stück	1	6	12
270 57 26 Holzoptik, weiss, 26.5 x 16.2 cm	1	1	21.00	18.90 10 %
270 57 27 Holzoptik, schwarz, 26.5 x 16.2 cm	1	1	21.00	18.90 10 %
270 57 35 Holzoptik, weiss, 26.5 x 16.2 cm	1	1	31.00	27.90 10 %
270 57 27 Holzoptik, schwarz, 26.5 x 16.2 cm	1	1	31.00	27.90 10 %





Metall-Untersätze

CNS poliert, für Gläser und Flaschen

		Stück	1	6	12
282 01 11	11.5 cm Ø	1 1 =	11.00 5.50	9.90 4.95	8.80 4.40



Metall-Tabletts

CNS 18/10

		Stück	1	12	30
282 12 22	21.5 x 13 cm, H: 1.5 cm	1	11.00	9.90	8.80
282 12 23	23 x 23 cm, H: 1.5 cm	1	12.00	10.80	9.60
282 10 26	Oval, 26.5 x 19 cm	1	12.00	10.80	9.60
282 10 29	Oval, 29 x 22 cm	1	12.00	10.80	9.60



Metall-Tabletts

CNS mattiert

		Stück	1	12	30
282 16 20	20 x 11 cm	1	11.00	9.90	8.80
282 16 29	29 x 20 cm	1	21.00	18.90	16.80
282 16 21	20 x 20 cm	1	16.00	14.40	12.80
270 30 09	Schale Melamin weiss, 9 x 9 cm, H: 4 cm	6		5.40	4.32
270 49 09	Schale Melamin schwarz, 9 x 9 cm, H: 4 cm	6		5.60	4.48



Aluminium-Tabletts Snack

Aluminium, nicht spülmaschinengeeignet

		Stück	1	12	30
282 26 32	31.5 x 21.5 cm	1	17.30	15.57	13.84
282 26 37	37 x 26.5 cm	1	23.80	21.42	19.04



Miniconcept Paper

Fettabweisendes, bedrucktes Papier

		Stück	1	12	30
240 70 13	Paper Daily Catch, 25 x 42 cm	1	82.00	73.80	65.60
240 70 45	Karo rot, 25 x 42 cm	1	82.00	73.80	65.60
240 70 65	Karo blau, 25 x 42 cm	1	82.00	73.80	65.60
240 70 14	Steak House Burger, 25 x 35 cm	1	1000	88.60	79.74

Service



Dinetray

Dinetray - Für einen schnellen Mittag-Service kann zum Beispiel ein ganzes Menu mit Vor-, Hauptspeise und Salat oder Dessert auf einmal serviert werden. Ideal aber auch im Room-Service oder als Tablett zum Servieren von Finger-Food. Das randlose Tablett für GN 1/1 Einschub, aus CNS 18/10. Die Velvet-Touch-Sets, schieferfarbig, verhindern das Rutschen. Modell- und Markenschutz. Design brunelli

Serviertablett Dinetray für:

- Business-Lunch
- Express-Menu
- Jet-Set-Menu
- Room-Service



		Stück	1	12	30
282 14 42	Dinetray mit Griffen, 41,6 x 32,5 cm	1	53.00	47.70 10 %	42.40 20 %
282 14 53	Dinetray mit Griffen, 53 x 32,5 cm	1	58.00	52.20	46.40

Velvet Touch antirutsch

Praktische Antirutsch-Unterlagen, Farbe schiefermatt

		Stück	1	6	12
105 90 00	35,5 x 31,5 cm für Dinetray 2821442	1 500 1 =	180.00 0.36	162.00 0.32	144.00 0.29
105 90 01	46,2 x 31,5 cm für Dinetray 2821453	1 500 1 =	219.00 0.44	197.10 0.40	175.20 0.35





Servitray Tablett und Rahmen

Servitray Tablett und Rahmen - Ideal für jeden Anlass

Das Servitray Tablett mit der praktischen Gastronorm-Grösse 2/4 ist das multifunktionale Organisationstalent. Servitray Tablett passen auf alle GN 2/1 Regalwagen. Verleihen Sie Ihrem Buffet eine besondere Note. Servitray sorgt für genügend Platz und lässt Spielraum für Ästhetik mit den unterschiedlich hohen Rahmen, so dass sich Ihr Buffet jeden Tag neu präsentiert. Die schmalen Tablett, bestückt mit Velvet Touch Papier, für den perfekten Halt beim Servieren von Flying Buffets. Velvet Touch Papier ist recyclebar und leistet daher seinen Beitrag an die Ökologie. Design brunelli

		Stück	1	12	30
282 14 24	Servitray Tablett, 530 x 162 mm	1	29.50	26.55	23.60
				10 %	20 %
105 90 02	Velvet Touch antirutsch, 46,2 x 15 cm	1	500	112.00	100.80
			1 =	0.22	0.20
282 25 06	Rahmen, H: 6 cm, stapelbar	1	29.50	26.55	23.60
				10 %	20 %
282 25 12	Rahmen, H: 12 cm, stapelbar	1	31.50	28.35	25.20
282 25 18	Rahmen, H: 18 cm, stapelbar	1	37.50	33.75	30.00

Tablettständer

CNS 18/10, Gestell aus Chromnickelstahl mit schwarzen Gurtenbändern

		Stück	1	6	12
282 15 00	50 x 39 cm, H: 79 cm	1	1	59.00	53.10 10 % 47.20 20 %



Gläserständer

Der Gläserständer lässt sich im Handumdrehen auf 3 unterschiedliche Höhen individuell umbauen (49 cm, 71 cm und 94 cm).

Set enthält:

- 4 Glasplatten ø60cm, ø55cm, ø50cm, ø45cm
- 1 Gewindestange 23,5cm
- 2 Gewindestangen 47cm
- 1 Verchromter Fuss mit Abdeckung

		Stück	1	10 %	1
280 01 04	Gläserstapler Set	1	1	790.00	711.00



Gläser-Abtropfmatten

Unsere Rillenmatten aus PVC halten die Gläser gut durchlüftet - so beschlagen sie nicht. Sehr einfache Reinigung, für Buffets, Gläserabläre, Bartheiken etc.

		Stück	1	16.80	26.80	37.80
280 11 01	49 x 30 cm	1	1			
280 11 02	80 x 32 cm	1	1			
280 11 03	80 x 49 cm	1	1			



Gläser-Abtropfmatten Zuschnitte

Rollenbreite 98 cm, Richtung der Rillen: In Rollen-Länge, Preis pro cm Länge plus Schneidezuschlag pro Abschnitt

		Stück	1	0.85	5.80
280 10 00	98 cm breit, Preis per cm Länge, grau	1	1		
280 10 50	Schneidezuschlag pro Abschnitt	1	1		



Gläser-Abtropfgitter Barline

Hart-PVC, freier Wasserablauf durch Distanznocken, Steckvorrichtung an den Ecken

		Stück	1	12.25	17.50
280 15 00	30 x 20 cm	1	4		





1 Stück
1.50

Kinder-Malbüchlein

Fantasie-Büchlein zum Malen, Rätseln, Notieren, 6 Arten assortiert à ca. 24 Seiten, mit dickem Kartonrücken als Mal-Unterlage

		Stück		1
242 25 01	9.2 x 13 cm	1	32	48.00



Farbstifte

Schachteln à 6 Farben assortiert

		Stück		1	20 %
242 26 00	8.5 cm	1	10	17.00	13.60



Kinderstuhl Polly 2 in 1 Chicco

Ist von den wichtigsten europäischen Fachzeitschriften als bester Kinderhochstuhl ausgezeichnet worden. Mit 2 hinteren Rollen mit Bremsen und 2 Standfüßen. Gestell lässt sich einfach demontieren. Sitz ist 7-fach höhenverstellbar, 3fach verstellbare Rückenlehne. Der 2-fach höhenverstellbare 5-Punkt-Sicherheitsgurt sorgt für optimale Sicherheit

		Stück		1	10 %
242 21 00	82 x 63.5 cm, H: 92 - 104 cm	1	1	269.00	242.10



Kindersitz Chicco

Zusammenklappbar, zum Anhängen an den Tisch, für Kinder von 6 Monaten bis 3-jährig (bis 15 kg). Stahlrohr mit abnehm- und waschbarem Bezug

		Stück		1	15 %
242 20 00	60 x 40 cm, H: 27 cm	1	1	98.00	83.30



Kinderbett Easy Sleep

Klappbar, inkl. Matratze, Bezug waschbar, zusammengeklappt: 26.5 x 28.5 x 80.5 cm

		Stück		1
242 24 55	124 x 64 cm, H: 79 cm, 14 kg	1	1	119.00



Wandwickeltische dry baby

Kunststoff abwaschbar, mit Sicherheitsgurt, benötigt wenig Platz

Der geschlossene Wickeltisch ist nicht tiefer als 10 cm, offen 51 cm, Nutzlast 100 kg

		Stück		1
242 22 00	Seitenmontage, geschlossen, 90 x 46 x 10 cm	1	1	450.00
242 22 01	Frontmontage, geschlossen, 84 x 51 x 10 cm	1	1	450.00

Service



Robert Welch Kinderbesteck Green

	Pièce		1
152 13 00	1	1	25.40 20.32 20 %
Set 3-teilig			



Kinderbesteck Painting Chromstahl 18%, 3-teilig

	Pièce		1
152 14 00	1	1	8.90
3-teilig			



Robert Welch Kindergeschirr Melamin, 4-teilig

	Pièce		1
134 19 15	1	4	49.60 39.68 20 %
lemon			
134 19 55	1	4	49.60 39.68
apple			
134 19 75	1	4	49.60 39.68
plum			



Kinderteller hulu Mouse Porzellan, weiss

	Pièce		1
134 20 00	3	1	21.50 16.13 25 %
24.5 x 27.5 cm			



Lätzchen Happy Kids Vlies/Pearl Coating

	Pièce		1
101 51 04	1	100	27.00
20 x 32 cm			



Kids Stuff - Box Mit 80 Kindergeschenken

	Pièce		1
242 27 00	3	1	245.00
45 x 35 cm, H: 23 cm			

Warmbuffet BASIC LINE W-3 Design

Mobiles Warmbuffet für eine appetitliche Speisenpräsentation. Edelstahlabdeckung mit drei einzeln, nass oder trocken beheizbaren Bain-Maries für GN 1/1. Serienmässig mit Design-Hustenschutz, Wärmestrahler und LED Beleuchtung.

Weitere Modelle und Farben auf Anfrage

	Pièce		1
270 92 03	1	1	10650.00 8520.00 20 %
GN: 3 x 1/1, Eiche rustikal, 125.4 x 69 cm, H: 130.5 cm, 400 V, 3000 W, Stecker Typ 15			



Warmbuffet BASIC LINE W-3 Kids

Kinderfreundliches Warmbuffet für die Schulverpflegung oder Family-Restaurants. Edelstahlabdeckung mit drei einzeln, nass oder trocken beheizbaren Bain-Maries für GN 1/1. Mit Hustenschutz bedienseitig, Wärmestrahler und LED Beleuchtung. Ausgabehöhe: 75 cm

Weitere Modelle und Farben auf Anfrage

	Pièce		1
270 93 03	1	1	11550.00 9240.00 20 %
GN: 3 x 1/1, Eiche rustikal, 125.4 x 69 cm, H: 105.5 cm, 230 V, 2200 W, Stecker Typ 12			



ab
8.80



Namensschilder PC Atlantis Mini

Für Kärtchen 6.3 x 2.2cm, Rahmen transparent, mit Abdeckfolie

		Stück	1	50	100
340 11 00	Magnet-System	1	1	11.00	8.80
340 09 01	Anstecknadel	1	1	6.30	5.04
340 11 50	Ersatzabdeckung	1	1		2.60

Namensschilder PC Atlantis

Für Kärtchen 7.5 x 3.2cm, Rahmen weiss, mit Abdeckfolie



		Stück	1	50	100
340 10 00	Magnet-System	1	1	13.00	10.40
340 10 01	Anstecknadel	1	1	9.00	7.20
340 10 50	Ersatzabdeckung	1	50		159.00
			1=		2.98
340 10 51	Ersatzmagnet Clip Standard	1	1		3.20
340 10 52	Ersatz-Magnet Clip extra stark	1	1		5.30

Namensschilder Screen

Magnetsystem, für Kärtchen 7.5 x 3.2 cm, Rahmen weiss, mit Abdeckfolie



		Stück	1	50	100
340 00 00*	Magnet-System	1	1	8.00	6.40

Werbedruck auf Anfrage möglich



Bistro-Schürzen

100 % Baumwolle

		Stück	1	50	100
340 60 15	60 cm	1	2		28.00
			1=		12.45
340 70 45	100 cm	1	2		36.00
			1=		16.40

Halfter und Abrechnungstaschen

Weiches solides Porcleder, speziell für grosse Portemonnaies, mit Aussentasche 12.5 x 13 cm für Block und Kugelschreiber



		Stück	1	50	100
340 48 00	Schweinsleder, für grosse Kellnergeldbörsen, 21 x 14.5 cm	1	1	29.00	23.20
340 50 00	Abrechnungstasche mit Namensfeld, Kunstleder	1	1		8.90

Rollmatic-Schlüsselschnur

Ausziehbare Schnur mit starker Rückholfeder für automatischen Rückzug, mit Schlüsselring und Clip für die Befestigung am Gürtel, 2 Stück



		Stück	1	50	100
340 20 10	Set à 2	1	2	22.00	19.80
			1=		

Service

Münzkästli Chic

Edles Münzkästli in dunkelbraunem Kunstleder eingefasst

		Stück			1
231 33 85	14 x 24.5 cm	1	1	37.00	29.60 20 %



Rechnungstablett

Edelstahltablett 18/0 hochglanzpoliert, inkl. 1 klappbare Ledermappe mit Stiftflasche und Magnethalterung

		Stück			1
231 32 00	20 x 16 cm	1	1	38.00	30.40 20 %



Kellner-Geldtasche

Porcleder, mit grossem Münzfach, 4 Notenfächern, 1 Fach mit Reissverschluss und 1 Aussenfach für Notizblock

		Stück			1
340 45 00	18 x 11 cm	1	1	32.00	25.60 20 %



Kellner-Geldtasche

Weiches Vollrindleder, mit grossem Münzfach, 4 Notenfächern, 1 Fach mit Reissverschluss und 1 Aussenfach für Notizblock

		Stück			1
340 47 00	18.5 x 10 cm	1	1	40.00	32.00 20 %



Geldzähl-Kassetten / Sortikord Sortiergerät

Jede Münze steckt griffsicher in ihrer Rille; Zählfehler sind damit ausgeschlossen

		Stück			1
350 01 00	Metallkoffer CHF mit Münzeinsatz und Banknotenfach, 30 x 24.2 cm, H: 10.2 cm, 3.4 kg	1	1		235.00
350 01 50	Münzeinsatz CHF, 27.6 x 17.9 cm, H: 7 cm	1	1		69.00
350 16 00	Sortiergerät, von CHF 0.05 bis 5.00, 23.5 x 20.5 cm, H: 15.5 cm	1	1		229.00





Kassablocks

Strichperforiert, alle Blätter nummeriert, erstes Blatt schwarz bedruckt, 13,5 x 10/16,5 cm
50 Blatt

		Stück	1	5	10
360 00 00	Nota-Block, Duplicat	1	50	85.00	76.50
			1 =	1.70	1.53
360 00 01	Nota-Block, Duplicat	1	1		1.80
360 01 00	Service-Bestellblock, Duplicat	1	50	85.00	76.50
					10 %
360 01 01	Service-Bestellblock, Duplicat	1	1		1.70
360 02 00	Service-Bestellblock, Triplicat	1	50	109.00	98.10
			1 =	2.18	1.96
360 02 01	Service-Bestellblock, Triplicat	1	1		2.30
360 03 00	Menü-Bestellblock, Duplicat	1	50	85.00	76.50
			1 =	1.70	1.53
360 03 01	Menü-Bestellblock, Duplicat	1	1		1.80



Kassa-/Service-Laufbonblocks

18,4 x 12/21,5 cm. Kassa- und Service-Laufbons in einem Block! Mit 4 Coupons (H: 32, 26, 73 und 53 mm), jeder mit derselben Servicenummer, Aufdruck: Client Montant Entre-mets Fr. La Suite Fr. Entrées Fr.
50 Blatt

		Stück	1	5	10
360 05 00	Duplicat	1	40	180.00	162.00
			1 =	4.50	4.05
360 05 01	Duplicat	1	1		4.80
360 06 00	Triplicat	1	40	238.00	214.20
			1 =	5.95	5.36
360 06 01	Triplicat	1	1		6.00



Kassablock-Deckel

Kunststoff, je eine Klemme für den Block und für beschriebene Blätter, zentrale Kugelschreiber-Halterung

		Stück	1	12	30
360 10 01	19 x 11,5 cm, für: 3600000 -3600301	1	1	16.80	15.96
					5 %
360 10 02	24 x 16,5 cm, für: 3600500 -3600601	1	1	21.00	19.95



Coupon-Aufspieser

mit Holzfuß, Spiesse aus kurzem, flexiblem Kunststoff

		Stück	1		1
360 60 03	19,5 x 6 cm, H: 11 cm	1	1		7.90



Coupons/Zahnstocher Glas

		Stück	1	60	120
170 45 00	H: 58 mm, 48 mm Ø	12	1	1.10	0.99
					10 %
					0.88

Bonbücher

Original perforiert, Kopie fest, 6 Bons 9.3 x 3.3cm /Seite
360 Bons

		Stück	1	3	6
360 63 00	weiss, 20 x 10.4 cm	1	10	83.00	78.85 74.70
360 63 11	gelb, 20 x 10.4 cm	1	10	83.00	78.85 74.70
360 63 31	rosa, 20 x 10.4 cm	1	10	85.00	80.75 76.50
360 63 51	grün, 20 x 10.4 cm	1	10	83.00	78.85 74.70
360 63 60	blau, 20 x 10.4 cm	1	10	85.00	80.75 76.50



Wand-Haftmagnete

1 Metallband weiss 100 x 3 cm, zum selber zuschneiden, selbstklebend, mit 10 Magnet-Haftknöpfen rot, 3 cm Ø

		Stück	1
350 45 00	Schiene inkl. Magnete	1	1 28.00
350 45 50	Knopfmagnete rot	1	10 11.50



Info-Board/Zettelhalter

Schnelles und bequemes Klemmen von Zetteln aller Art

		Stück	1
350 51 06	60 cm	1	1 48.00 28.80
350 51 09	90 cm	1	1 65.00 39.00



ab
28,80

Jasskarten und Zubehör

		Stück	1	6	12
361 30 00	Karten CH Deutsche	1	10	16.90	16.06 15.21
361 31 00	Karten CH Französische	1	10	16.10	15.30 14.49
361 35 00	Jasstafel, 16.5 x 23.5 cm	1	1	9.90	9.41 8.91
361 36 00	Jass Stifte, 17.3 x 0.9 cm	1	12	21.10	20.05 18.99
			1=	1.76	1.67 1.58
361 38 00	Kunststoff-Schwämme	1	10	34.80	33.06 31.32
361 40 00	Jass-Teppich, 60 x 60 cm	1	1		39.00



Zeitungshalter Buchenholz

		Stück	1
361 10 42	42/61 cm	1	1 17.60
361 10 52	52/70 cm	1	1 19.80
361 10 57	57/75 cm	1	1 18.80



hulu Zeitungs- oder Illustrierte Wandhalter

Verchromt oder aus Acrylglas, mehrere Halter können zusammengefügt werden

		Stück	1
361 00 00	4 Fächer für Zeitungen oder Illustrierte, Chromnickelstahl, 25 cm, H: 50 cm, T: 12 cm	1	1 28.00 19.60
361 01 00	4 Fächer für Zeitungen oder I Illustrierte, Chromnickelstahl, 20 cm, H: 58 cm, T: 7 cm	1	1 28.00 19.60
361 05 00	9 Zeitungen, Acryl, 17.5 cm, H: 78 cm	1	1 187.60



Küche



LIEBHERR

NOSER-INOX
Industrie- und Hausgeräte

robot *à* coupe



Magic-Saver®



ROTOR



BLANCO



SCHOLL
... ohne Idee voran!



cool compact®



LeChef



premi Star





Küche

Pfannen / Töpfe
Küchenutensilien
GN-Schalen
Maschinen
Apparate
Hygiene



EcoStar

Schwere und robuste Ausführung aus Edelstahl 18/10, ausgestattet mit energieeffizientem Aluminiumkapselboden, für alle Herdarten geeignet



Sauteusen EcoStar

Pfanne aus Edelstahl 18/10, 6 mm starker Kapselboden mit Aluminiumkern für eine optimale Hitzeverteilung

		Stück		1
				20 %
400 85 16	16 cm Ø, H: 6 cm, 1,2 l	1	1	39,00 31,20
400 85 20	20 cm Ø, H: 6,5 cm, 2 l	1	1	52,00 41,60
400 85 24	24 cm Ø, H: 7 cm, 3,4 l	1	1	65,00 52,00

ab
28,80



Stielkasserollen EcoStar

		Stück		1
				20 %
405 03 16	16 cm Ø, H: 7,5 cm, 1,5 l	1	1	36,00 28,80
405 03 20	20 cm Ø, H: 10,5 cm, 3,3 l	1	1	53,00 42,40
405 03 24	24 cm Ø, H: 11 cm, 5,0 l	1	1	64,00 51,20



Bratentöpfe EcoStar

		Stück		1
				20 %
405 00 28	28 cm Ø, H: 13 cm, 8,0 l	1	1	83,00 66,40
405 00 32	32 cm Ø, H: 16 cm, 12,9 l	1	1	128,00 102,40
405 00 36	36 cm Ø, H: 18 cm, 18,3 l	1	1	159,00 127,20
405 00 40	40 cm Ø, H: 15 cm, 18,9 l	1	1	175,00 140,00



Fleischtöpfe EcoStar

		Stück		1
				20 %
405 01 28	28 cm Ø, H: 18 cm, 11,1 l	1	1	94,00 75,20
405 01 32	32 cm Ø, H: 20 cm, 16,1 l	1	1	146,00 116,80
405 01 36	36 cm Ø, H: 22 cm, 22,4 l	1	1	174,00 139,20
405 01 40	40 cm Ø, H: 25 cm, 31,4 l	1	1	214,00 171,20

ab
71,20



Kochtöpfe EcoStar

		Stück		1
				20 %
405 02 24	24 cm Ø, H: 24 cm, 10,8 l	1	1	89,00 71,20
405 02 28	28 cm Ø, H: 28 cm, 17,2 l	1	1	116,00 92,80
405 02 32	32 cm Ø, H: 32 cm, 25,7 l	1	1	185,00 148,00
405 02 36	36 cm Ø, H: 36 cm, 36,6 l	1	1	226,00 180,80
405 02 40	40 cm Ø, H: 40 cm, 50,2 l	1	1	286,00 228,80

Küche

Promess

Schwere, robuste Ausführung aus Edelstahl 18/10 mit ausgeprägtem Schüttrand und wärmeisolierenden Griffen. Der energieeffiziente Mehrschichtboden sorgt für eine optimale Wärmeübertragung und ist für alle Herdarten geeignet.

Stielkasserollen nieder CNS Promess

		Stück		1
				30 %
400 43 16	16 cm Ø, H: 6.5 cm, 1.3 l	1	1	67.00 46.90
400 43 20	20 cm Ø, H: 7.5 cm, 2.5 l	1	1	78.00 54.60
400 43 24	24 cm Ø, H: 8 cm, 3.7 l	1	1	97.00 67.90



Stielkasserollen CNS Promess

		Stück		1
				30 %
400 32 16	16 cm Ø, H: 9.5 cm, 1.9 l	1	1	71.00 49.70
400 32 20	20 cm Ø, H: 12 cm, 3.8 l	1	1	85.00 59.50
400 32 24	24 cm Ø, H: 14.5 cm, 6.5 l	1	1	109.00 76.30



Fleisch-/Gemüsetöpfe CNS Promess

		Stück		1
				30 %
400 31 28	28 cm Ø, H: 16.8 cm, 10.3 l	1	1	155.00 108.50
400 31 32	32 cm Ø, H: 19.5 cm, 15.4 l	1	1	196.00 137.20
400 31 36	36 cm Ø, H: 21.5 cm, 22 l	1	1	243.00 170.10
400 31 40	40 cm Ø, H: 24 cm, 30.1 l	1	1	326.00 228.20



Kochtöpfe CNS Promess

		Stück		1
				30 %
400 30 24	24 cm Ø, H: 24 cm, 10.5 l	1	1	128.00 89.60
400 30 28	28 cm Ø, H: 26 cm, 16 l	1	1	186.00 130.20
400 30 32	32 cm Ø, H: 28 cm, 22.5 l	1	1	227.00 158.90
400 30 36	36 cm Ø, H: 32.5 cm, 33 l	1	1	308.00 215.60
400 30 40	40 cm Ø, H: 36.5 cm, 46 l	1	1	387.00 270.90



Sauteusen Profi Star

Edelstahl 18/10 mit Aluminiumkern, hochwertige 3-Schicht-Sauteuse aus Edelstahl

		Stück		1
				20 %
400 90 16	16 cm Ø, H: 6 cm, 1.0 l	1	1	61.00 48.80
400 90 18	18 cm Ø, H: 6 cm, 1.2 l	1	1	68.00 54.40
400 90 20	20 cm Ø, H: 6.5 cm, 1.7 l	1	1	78.00 62.40
400 90 24	24 cm Ø, H: 7.5 cm, 2.9 l	1	1	107.00 85.60



Wok-Pfanne mit Gegengriff EcoStar

Schwere und robuste Ausführung aus Edelstahl 18/10, ausgestattet mit energieeffizientem Aluminiumkapselboden, für alle Herdarten geeignet

		Stück		1
400 88 36	36 cm Ø, H: 10 cm, 7 l	1	1	149.00



Noser-Inox Gusto

Aus hochwertigem Edelstahl, mehrschichtiger Materialaufbau mit Aluminiumkern, äusserst schnelle und gleichmässige Wärmeaufnahme und -verteilung, auch an den Seitenwänden, handlich und leicht, einfach zu reinigen, mit ergonomischen Stielen.



Saucenpfännchen Noser

Das kleine Mehrschicht-Pfännchen mit der besonderen Leitfähigkeit für alle Herdarten

			Stück		1
400 10 11	11 cm Ø, H: 5.5 cm, 0.4 l	1	1		59.00



Sauteusen Noser

			Stück		1
400 15 14	14 cm Ø, H: 5.5 cm, 0.7 l	1	1	108.00	91.80
400 15 16	16 cm Ø, H: 6.5 cm, 1.0 l	1	1	115.00	97.75
400 15 18	18 cm Ø, H: 7 cm, 1.3 l	1	1	123.00	104.55
400 15 20	20 cm Ø, H: 7.5 cm, 1.5 l	1	1	135.00	114.75
400 15 24	24 cm Ø, H: 8.5 cm, 2.75 l	1	1	158.00	134.30
400 15 26	26 cm Ø, H: 9 cm, 3.5 l	1	1	170.00	144.50



Stielkasserollen nieder Noser

			Stück		1
400 29 16	16 cm Ø, H: 8 cm, 1.5 l	1	1	111.00	94.35
400 29 18	18 cm Ø, H: 8.5 cm, 2 l	1	1	118.00	100.30
400 29 20	20 cm Ø, H: 8.5 cm, 2.5 l	1	1	128.00	108.80
400 29 22	22 cm Ø, H: 9.5 cm, 3.25 l	1	1	140.00	119.00



Stielkasserollen hoch Noser

			Stück		1
400 16 16	16 cm Ø, H: 10.5 cm, 2 l	1	1	129.00	109.65
400 16 18	18 cm Ø, H: 12 cm, 3 l	1	1	146.00	124.10
400 16 20	20 cm Ø, H: 13 cm, 4 l	1	1	171.00	145.35
400 16 22	22 cm Ø, H: 13.5 cm, 5 l	1	1	192.00	163.20



Kasserollen nieder Noser

			Stück		1
400 17 24	24 cm Ø, H: 9.5 cm, 4.25 l	1	1	160.00	136.00
400 17 28	28 cm Ø, H: 10.5 cm, 6.5 l	1	1	194.00	164.90
400 17 32	32 cm Ø, H: 12.5 cm, 10 l	1	1	236.00	200.60



Fleischtöpfe 3/4 hoch Noser

			Stück		1
400 28 24	24 cm Ø, H: 14.5 cm, 6.5 l	1	1	225.00	191.25
400 28 28	28 cm Ø, H: 16.5 cm, 10 l	1	1	295.00	250.75
400 28 32	32 cm Ø, H: 20 cm, 16 l	1	1	379.00	322.15

Küche

Noser-Inox Hotel - weil Qualität zählt!

Schweizer Produkt. Extra schwere Ausführung, aus säurebeständigem Chromnickelstahl 1.4404 mit Molybdänlegierung in 1.5 mm Materialstärke, mit Schüttrand, massive Beschläge und dickem, mehrschichtigem Wärmeleitboden.

Sauteusen Noser

		Stück		1
				10 %
400 14 18	18 cm Ø, H: 7.7 cm, 1.5 l	1	1	495.00 175.50
400 14 20	20 cm Ø, H: 7.7 cm, 1.8 l	1	1	217.00 195.30
400 14 24	24 cm Ø, H: 8.5 cm, 3 l	1	1	243.00 218.70
400 14 26	26 cm Ø, H: 9.9 cm, 4 l	1	1	301.00 270.90



Stielkasserollen 3/4 hoch Noser

		Stück		1
				10 %
400 25 16	16 cm Ø, H: 11 cm, 2 l	1	1	149.00 134.10
400 25 18	18 cm Ø, H: 12.5 cm, 3 l	1	1	180.00 162.00
400 25 20	20 cm Ø, H: 13.5 cm, 4 l	1	1	213.00 191.70
400 25 22	22 cm Ø, H: 14.5 cm, 5 l	1	1	251.00 225.90
400 25 24	24 cm Ø, H: 15.5 cm, 6 l	1	1	290.00 261.00
400 25 26	26 cm Ø, H: 16.5 cm, 8 l, mit zusätzlichem Handgriff	1	1	357.00 321.30



Fleischtöpfe 3/4 hoch Noser

		Stück		1
				10 %
400 33 16	16 cm Ø, H: 11 cm, 2 l	1	1	126.00 113.40
400 33 18	18 cm Ø, H: 12.5 cm, 3 l	1	1	163.00 146.70
400 33 20	20 cm Ø, H: 13.5 cm, 4 l	1	1	197.00 177.30
400 33 22	22 cm Ø, H: 14.5 cm, 5 l	1	1	232.00 208.80
400 33 24	24 cm Ø, H: 15.5 cm, 6 l	1	1	269.00 242.10
400 33 26	26 cm Ø, H: 16.5 cm, 8 l	1	1	323.00 290.70
400 33 28	28 cm Ø, H: 18 cm, 11 l	1	1	380.00 342.00
400 33 30	30 cm Ø, H: 19 cm, 12.5 l	1	1	438.00 394.20
400 33 32	32 cm Ø, H: 20 cm, 15 l	1	1	512.00 460.80
400 33 36	36 cm Ø, H: 22 cm, 21 l	1	1	701.00 630.90
400 33 40	40 cm Ø, H: 25 cm, 29.5 l	1	1	804.00 723.60
400 33 44	44 cm Ø, H: 26 cm, 38 l	1	1	901.00 810.90



Bouillenkessel hoch Noser

		Stück		1
				10 %
400 26 22	22 cm Ø, H: 19 cm, 7 l	1	1	266.00 239.40
400 26 24	24 cm Ø, H: 22 cm, 9 l	1	1	320.00 288.00
400 26 26	26 cm Ø, H: 26 cm, 12 l	1	1	361.00 324.90
400 26 28	28 cm Ø, H: 28 cm, 17 l	1	1	430.00 387.00
400 26 32	32 cm Ø, H: 33 cm, 25 l	1	1	574.00 516.60
400 26 36	36 cm Ø, H: 37 cm, 35 l	1	1	803.00 722.70
400 26 40	40 cm Ø, H: 41 cm, 48 l	1	1	889.00 800.10
400 26 44	44 cm Ø, H: 45 cm, 65 l	1	1	1063.00 956.70



Teigwaren-Einsätze CNS 18/10

Für Kochtöpfe ab 36 cm Ø

		Stück		1
				20 %
400 37 00	mit Fiberglasgriff, H: 23 cm	1	1	54.00 43.20
400 38 00	5.5 l, H: 23 cm	1	1	78.00 62.40



NEW



Pro-Diamond

Umweltfreundliche, PFOA-freie Pfannen mit hochwertigem 6-Schicht-Material und einem einzigartigen Design. Induktionstauglicher Pfannenboden aus Aluminium garantiert eine schnelle und gleichmässige Wärmeverteilung.

Bratpfannen Pro-Diamond nieder



- 400 84 20 20 cm Ø
- 400 84 24 24 cm Ø
- 405 84 28 28 cm Ø

Stück			1
1	1	34.00	27.20
1	1	42.00	33.60
1	1	50.00	40.00

Bratpfannen Pro-Diamond hoch



- 400 83 28 28 cm Ø, 7.5 cm
- 400 83 32 32 cm Ø, 8.5 cm

Stück			1
1	1	58.00	46.40
1	1	71.00	56.80

Stielkasserollen Pro-Diamond



- 400 81 16 16 cm Ø, H: 8 cm
- 400 81 20 20 cm Ø, H: 11 cm
- 400 81 24 24 cm Ø, H: 13 cm

Stück			1
1	1	35.00	28.00
1	1	47.00	37.60
1	1	61.00	48.80

Kochtöpfe Pro-Diamond hoch



- 400 82 28 28 cm Ø, H: 23 cm
- 400 82 32 32 cm Ø, H: 25 cm

Stück			1
1	1	101.00	80.80
1	1	121.00	96.80



Bratpfannen Le Chef

Profipfanne aus Aluminiumguss mit wechselnder Wandstärke für ein gleichmässiges Garen. Mit patentierter, umweltfreundlicher Durion-Antihaftbeschichtung ohne PFOA.

Pfanne mit abnehmbarem Griff für eine noch bessere Handhabung und einfaches Auswechseln des Pfannenkörpers.

- Profipfanne für alle Herdarten
- Schnelles, gleichmässiges Garen
- Gesundheitlich unbedenkliche Antihafbeschichtung
- Energieeffizient und umweltfreundlich

Bratpfannen Le Chef

		Stück		1
				20 %
400 73 20	20 cm Ø	1	1	80.00 64.00
400 73 24	24 cm Ø	1	1	95.00 76.00
400 73 26	26 cm Ø	1	1	104.00 83.20
400 73 28	28 cm Ø	1	1	108.00 86.40
400 73 30	30 cm Ø	1	1	124.00 99.20



Grillpfanne Le Chef

		Stück		1
				20 %
400 72 27	27 x 27 cm	1	1	99.00 79.20



ab
36.-



Eisen-Bratpfannen

Mit beschichtetem Metallstiel, auch für Induktionsherde
Bitte Gebrauchsanweisung beachten!

		Stück		
400 55 22	22 cm Ø	1	1	36.00
400 55 24	24 cm Ø	1	1	39.00
400 55 28	28 cm Ø	1	1	53.00
400 55 32	32 cm Ø	1	1	59.00
400 55 36	36 cm Ø	1	1	75.00



Grillpfannen Gusseisen Irony

Gusseisen, schwere Qualität, Griff aus Edelstahl 18/10

		Stück		
400 44 24	24 x 24 cm	1	1	170.00 136.00
400 44 28	28 x 20 cm	1	1	172.00 137.60



Grillpfanne Gusseisen Irony

Gusseisen, schwere Qualität, Griff aus Edelstahl 18/10

		Stück		
400 44 28	28 x 20 cm	1	1	172.00 137.60



Grillpfanne Gusseisen Irony

Gusseisen, schwere Qualität, Griff aus Edelstahl 18/10

		Stück		
400 44 27	27 cm Ø	1	1	168.00 134.40



Grillpfanne Gusseisen Melior

Auch für Induktionsherde

		Stück		
400 56 33	33 cm Ø	1	1	299.00



Bratpfannen Valira

Pfanne aus Aluminiumguss mit hochwertiger Antihafbeschichtung, entwickelt für die Gastronomie

		Stück		
400 70 20*	20 cm Ø	1	1	79.00 63.20
400 70 28*	28 cm Ø	1	1	109.00 87.20
400 70 32*	32 cm Ø	1	1	115.00 92.00



Flambierpfanne Profi de Luxe

Edelstahl 18/10, in schwerer Ausführung, hochwertiges 3-Schicht-Material aus Kupfer, Aluminium

		Stück		
400 94 28	28 cm Ø, H: 5 cm	1	1	196.00 156.80

Küche

Bratpfannen EcoStar

Edelstahl 18/10, mit Teflon "Platinum" Antihaftbeschichtung, 6 mm starker Kapselboden mit Aluminiumkern für eine optimale Hitzeverteilung

		Stück		1
				20 %
400 86 20	20 cm Ø, H: 4.5 cm	1	1	52.00 41.60
400 86 24	24 cm Ø, H: 5 cm	1	1	75.00 60.00
400 86 28	28 cm Ø, H: 5 cm	1	1	94.00 75.20
400 86 32	32 cm Ø, H: 5 cm	1	1	122.00 97.60



Bratpfannen Profi Star

Edelstahl 18/10, mit Aluminiumkern, hochwertige 3-Schicht-Material Bratpfanne

		Stück		1
				20 %
400 92 20	20 cm Ø	1	1	72.00 57.60
400 92 24	24 cm Ø	1	1	88.00 70.40
400 92 28	28 cm Ø	1	1	115.00 92.00
400 92 32	32 cm Ø	1	1	128.00 102.40



Bratpfannen Profi Star

Edelstahl 18/10, mit Aluminiumkern, mit strapazierfähiger DIAMAS-PRO-Antihaftbeschichtung, hochwertige 3-Schicht-Material Bratpfanne

		Stück		1
				20 %
400 93 20	20 cm Ø	1	1	73.00 58.40
400 93 24	24 cm Ø	1	1	90.00 72.00
400 93 28	28 cm Ø	1	1	124.00 99.20
400 93 32	32 cm Ø	1	1	157.00 125.60



ab
58.40

Titan-Bratpfannen

Gussaluminium mit Edelstahlgriff, Titaniumboden mit Antihaftbeschichtung, geeignet für jeden Herd ausser für den Induktionsherd

		Stück		1
				30 %
400 41 24	24 cm Ø	1	1	93.00 65.10
400 41 28	28 cm Ø	1	1	98.00 78.40
400 41 32	32 cm Ø	1	1	129.00 90.30
400 41 36	36 cm Ø	1	1	167.00 116.90



Vulcano Ceramic Spring

5-Lagen-Mehrschichtmaterial für optimale Wärmeleitung und -verteilung. Ceralon Keramik-Antihaftversiegelung. Backofenfest bis 400°C und PFOA-frei, sehr hohe Hitzebeständigkeit für schnelles, krosses und schonendes Anbraten. Extrem hohe Abriebfestigkeit, wiederbeschichtbar - 1 Jahr Garantie

Verwenden Sie kein Olivenöl, dies kann zu Beeinträchtigungen der Antihaftwirkung der Beschichtung führen!

		Stück		1
				10 %
400 59 20	20 cm Ø	1	1	79.00 71.10
400 59 24	24 cm Ø	1	1	99.00 89.10
400 59 28	28 cm Ø	1	1	119.00 107.10
400 59 32	32 cm Ø	1	1	139.00 125.10



Vulcano Profi GLI Pfannen Spring

Mehrschicht-Bratpfanne GLI mit Antihaft-Beschichtung DuPont "Autograph". 1 Jahr Garantie auf Antihaftbeschichtung, 10 Jahre auf den Pfannenkörper, wiederbeschichtbar

		Stück		1
				20 %
400 50 20*	20 cm Ø	1	1	79.00 63.20
400 50 24*	24 cm Ø	1	1	99.00 79.20
400 50 28	28 cm Ø	1	1	119.00 95.20
400 50 32	32 cm Ø	1	1	139.00 111.20





Couvercles en inox / Support mural de couvercles

En acier inoxydable 18/10

		📦	Pièce		1
400 35 16	16 cm Ø	1	1		14.80
400 35 18*	18 cm Ø	1	1		16.20
400 35 20	20 cm Ø	1	1		17.10
400 35 24	24 cm Ø	1	1		19.80
400 35 28	28 cm Ø	1	1		22.90
400 35 32	32 cm Ø	1	1		29.90
400 35 36	36 cm Ø	1	1		39.60
400 35 40	40 cm Ø	1	1		42.80
		📦	Pièce		1
400 36 00	Support pour 8 couvercles, H: 68 cm	1	1	53.00	20 % 42.40



Presse pommes de terre et Spätzle

Presse en inox 18/10, satiné poli, avec 3 inserts interchangeables pour la fabrication de purée, pâtes, etc..

Approprié pour le lave-vaisselle.

		📦	Pièce		1
401 71 00	0.35 l, 32 cm, 8 cm Ø	1	1	110.00	20 % 88.00



Passoire à boulettes

En aluminium

		📦	Pièce		1
400 39 32*	32 cm Ø	1	1	110.00	10 % 99.00



Robot à spätzli

Exécution lourde, perforation 7 mm, placer sur tous les pots de diamètre 36-45 cm Ø.

		📦	Pièce		1
400 39 46	45.5 x 15.5 cm, 2.2 kg	1	1	120.00	20 % 96.00



Cuiseur de riz

Convient à différentes sortes de riz ou pour faire cuire des légumes à la vapeur. Carrosserie en inox, cuve intérieure anti-adhésive. Verre mesureur, cuillère de riz inclus.

		📦	Pièce		1
430 37 02	2-10 personnes, 285 mm Ø, H: 285 mm, 0.6 l de riz/1.8 l d'eau l, 230 V, 700 W	1	1		61.00
430 37 06	25-40 personnes, 384 mm Ø, H: 375 mm, 6 l de riz/8 l d'eau l, 230 V, 1950 W	1	1		269.00



Cuiseur de riz XXL

Convient à différentes sortes de riz ou pour faire cuire des légumes à la vapeur. Carrosserie en inox, cuve intérieure anti-adhésive, tapis en silicone pour éviter les brûlures. Verre mesureur, cuillère de riz inclus.

		📦	Pièce		1
430 37 12	40-60 personnes, 465 mm Ø, H: 400 mm, 230 V, 2.85 kW, 15.6 kg, Prise type: 23	1	1		435.00

Küche

ab
9.80



Schöpflöffel

CNS 18/10, schwere Qualität, fugenlos

	Stück		1
401 00 07	1	1	14.00 9.80 30 %
6.5 cm Ø, 29.5 cm, 0.7 dl			
401 00 12	1	1	18.00 12.60
8 cm Ø, 32 cm, 1.25 dl			
401 00 20	1	1	20.00 14.00
9 cm Ø, 33 cm, 2.0 dl			
401 00 25	1	1	22.50 15.75
10 cm Ø, 36 cm, 2.5 dl			
401 00 50	1	1	32.00 22.40
12 cm Ø, 39 cm, 5.0 dl			
401 00 75	1	1	42.00 29.40
14 cm Ø, 43 cm, 7.5 dl			
401 01 10	1	1	48.00 33.60
16 cm Ø, 46 cm, 10 dl			



Saucenlöffel

Mit Ausguss, CNS 18/10, fugenlos

	Stück		1
401 10 07	1	1	22.00 15.40 30 %
6.5 cm Ø, 29.5 cm, 0.7 dl			
401 11 07	1	1	30.00 21.00
6.5 cm Ø, 36 cm, 0.7 dl			



Fleischgabel

CNS 18/8

	Stück		1
401 12 43	1	1	24.50 19.60 20 %
43 cm			



Bratschaufeln

	Stück		1
401 20 30	1	1	12.00 8.40 30 %
Polyamid, hitzebeständig bis 220°C, 31 cm			
401 21 31	1	1	2.40
Buchenholz, 31 cm			



Flacher Schaumlöffel

CNS 18/10, fugenlos

	Stück		1
401 05 08	1	1	11.00 8.80 20 %
8 cm Ø, 30 cm			
401 05 10	1	1	13.00 10.40
10 cm Ø, 33 cm			
401 05 12	1	1	16.00 12.80
12 cm Ø, 37 cm			
401 05 14	1	1	19.00 15.20
14 cm Ø, 39 cm			
401 05 16	1	1	24.00 19.20
16 cm Ø, 42 cm			



Friture-Kellen

CNS 18/8

	Stück		1
401 07 16	1	1	28.00 22.40 20 %
16 cm Ø, 47 cm			
401 07 18	1	1	31.00 24.80
18 cm Ø, 47 cm			



Nestback-Löffel

CNS 18/10

	Stück		1
401 08 12	1	1	26.00 20.80 20 %
12 cm Ø, 41 cm			



Universal-Schöpflöffel

CNS 18/10

	Stück		1
401 13 32	1	1	13.00 9.10 30 %
8 x 6 cm Ø, 32 cm			



Rührspaten

Exoglass, hitzebeständig bis 220° C

	Stück		1
401 35 25	1	1	6.20 4.96 20 %
25 cm			
401 35 30	1	1	7.50 6.00
30 cm			
401 35 35	1	1	8.30 6.64
35 cm			
401 35 40	1	1	12.00 9.60
40 cm			
401 35 45	1	1	16.00 12.80
45 cm			
401 35 50	1	1	19.00 15.20
50 cm			
401 36 00	1	1	61.40 49.12
Satz mit 6 Rührspaten			



Rührspaten Keulenform

	Stück		1
401 37 00	1	1	32.00 25.60 20 %
Buche, 80 cm			



Pinzettenzange CNS

	Stück		1
401 06 30	1	1	16.00 12.80 20 %
30 cm			



Grill-/Portionenzangen Kunststoff

Ideal für Töpfe und Pfannen, mit Spezialbeschichtung, hitzebeständig bis 240° C

	Stück		1
401 15 28	1	1	18.00
30 cm			



Bratschaufeln CNS 18/10

	Stück		1
			20 %
401 22 28	1	1	22.00 17.60
Perforiert, 28,5 x 8 cm			
401 23 54	1	1	25.00 20.00
Perforiert, 54 x 12 cm			
401 24 54	1	1	25.00 20.00
Unperforiert, 54 x 12 cm			



Kochlöffel

Exoglass, hitzebeständig bis 220° C

	Stück	1	
401 30 30	1	1	8.40
30 cm			
401 30 38	1	1	12.00
38 cm			
401 30 45	1	1	17.00
45 cm			
401 31 00	1	3	30.00
Set à 3 Stück, 30, 38, 45 cm			



Universal-Zangen

Küchenzange Edelstahl, rostfrei

	Stück	1	
			20 %
401 17 25	1	1	7.80 6.24
25 cm			
401 18 30	1	1	17.00 13.60
mit Silikonzange, 30 cm			
401 16 30	1	1	21.00 16.80
32 cm			



Spitzsieb (Chinois)

CNS 18/8

	Stück	1	
			10 %
401 47 23	1	1	33.00 29.70
24 cm Ø			



Spitzsieb mit Gazeboden

Exoglass, mit Stützbehälter

	Stück	1	
			20 %
401 48 20	1	1	123.00 98.40
20 cm Ø			



Spitzsieb mit Gazeboden

CNS 18/8

	Stück	1	
			20 %
401 49 24	1	1	66.00 52.80
24 cm Ø			



Küchensieb

CNS 18/8

	Stück	1	
			30 %
401 45 07	1	1	5.50 3.85
Teesieb, 7 cm Ø			
401 46 18	1	1	19.00 13.30
Küchensieb, 18 cm Ø			
401 46 22	1	1	22.50 15.75
Küchensieb, 22 cm Ø			



Durchschlag

CNS 18/8, Lochung 3 mm Ø, Stiellänge 28.5cm

	Stück	1	
			20 %
401 50 22	1	1	77.00 61.60
22 cm Ø			
401 50 26	1	1	89.00 71.20
26 cm Ø			



Trichter

Edelstahl

	Stück	1	
			20 %
401 63 10	1	1	8.00 6.40
10 cm Ø, H: 11.3 cm			
401 63 12	1	1	10.00 8.00
12 cm Ø, H: 11.3 cm			
401 63 15	1	1	12.00 9.60
15 cm Ø, H: 12.4 cm			



Messbecher Polypropylen

	Stück	1	
			20 %
403 00 28	1	1	9.90 7.92
1.0 l, 12.5 cm Ø			
403 00 29	1	1	17.20 13.76
2.0 l, 13.5 cm Ø			
403 00 30	1	1	18.80 15.04
3.0 l, 15.5 cm Ø			
403 00 31	1	1	19.90 15.92
5.0 l, 19 cm Ø			



Küchenmass

CNS 18/8

	Stück	1	
			20 %
401 60 10	1	1	18.00 14.40
Skala: 0.5, 10 dl, 1 l			
401 60 20	1	1	35.00 28.00
Skala: 0.5, 10, 20 dl, 2 l			



Trüffel- und Gourmet Hobel

Trüffelschneider aus Olivenbaumholz, Klinge aus rostfreiem, gehärtetem Stahl

	Stück	1	
			10 %
401 82 01	1	1	55.00 49.50
Klinge 6 cm			

Küche



Küchenschüsseln

CNS 18/8, mit Randbordüre, mittelschwere Qualität

	Stück	1	20 %
401 56 16 16 cm Ø	1	5.50	4.40
401 56 20 20 cm Ø	1	9.50	7.60
401 56 24 24 cm Ø	1	14.00	11.20
401 56 28 28 cm Ø	1	19.00	15.20
401 56 32 32 cm Ø	1	23.00	18.40
401 56 36 36 cm Ø	1	31.00	24.80



Küchenschüsseln

Edelstahl, bauchig, hohe Form, Randbordüre, schwere Qualität

	Stück	1	20 %
401 53 18 18 cm Ø	1	10.00	8.00
401 53 22 22 cm Ø	1	16.00	12.80
401 53 26 26 cm Ø	1	22.00	17.60
401 53 30 30 cm Ø	1	27.00	21.60
401 53 36 36 cm Ø	1	38.00	30.40
401 53 00 Set 4-tlg, 18,22,26,30 cm Ø	1	71.00	56.80



Thermoschüsseln

Edelstahl, doppelwandig, innen kugelförmig

	Stück	1	20 %
401 54 16 16 cm Ø	1	18.00	14.40
401 54 20 20 cm Ø	1	22.00	17.60
401 54 24 24 cm Ø	1	29.00	23.20
401 54 00 Set 3-tlg, 16,20,24 cm Ø	1	65.00	52.00

Set
69.00



Küchenschüsseln, Set à 5 Stück

CNS 18/8, mit Randbordüre, mittelschwere Qualität

	Stück	1	20 %
401 56 00 16,20,24,28,32 cm Ø	1	69.00	55.20



Gemüse-Seiher

Edelstahl, robuste Ausführung, mit Fussring

	Stück	1	25 %
401 65 18 36 cm Ø, H: 18.5 cm	1	195.00	146.25
401 65 20 40 cm Ø, H: 20 cm	1	218.00	163.50
401 65 22 45 cm Ø, H: 22.5 cm	1	253.00	189.75



Gemüse-Seiher

Edelstahl AISI 420, Randbordüre, schwere Qualität

	Stück	1	20 %
401 66 32 32 cm Ø, H: 17 cm	1	68.00	54.40
401 66 36 36 cm Ø, H: 18 cm	1	78.00	62.40
401 66 40 40 cm Ø, H: 21 cm	1	101.00	80.80



Schneebeesen

Griff absolut dicht, isoliert, hitzebeständig

	Stück	1	25 %
401 40 25 25 cm	1	24.00	18.00
401 40 30 30 cm	1	30.00	22.50
401 40 35 35 cm	1	33.00	24.75
401 40 40 40 cm	1	35.00	26.25
401 40 45 45 cm	1	52.00	39.00
401 40 50 50 cm	1	55.00	41.25



Schneebeesen

	Stück	1	20 %
401 41 25 25 cm	1	7.40	5.92
401 41 30 30 cm	1	9.80	7.84
401 41 35 35 cm	1	10.80	8.64



Streuer

CNS, H: 10.5 cm, 7 cm Ø

	Stück	1
441 72 00 Gewürz-/Salz-/Zuckerstreuer	1	9.50
441 73 00 Puderzucker-/Kakaostreuer	1	9.50



Ziseliermesser

		Stück	1	
410 20 00	1	1	9.60	8.64

Zitronen-Dekormesser



Zitronenschaber

		Stück	1	
410 21 00	1	1	9.10	8.19

Zitronenschaber



Demidow Buntschneidemesser

		Stück	1	
410 44 09	1	1	14.00	12.60

Demidow, 13 cm



Eierschneider

CNS 18/10, satiniert

		Stück	1	
401 79 10	1	1	17.00	13.60

10 x 8 cm



Eierstückler CNS

Teilt hartgekochte Eier in 6 gleiche Stücke

		Stück	1	
401 81 18	1	1	20.00	16.00

18 cm



Knoblauch- und Zwiebelpresse

Edelstahl, mit 2 herausnehmbaren Sieben

		Stück	1	
401 84 17	1	1		28.90

17 cm



Reis-Portionierer

Schalen und Feder in rostfreiem Stahl, Griffe aus hochglanzverchromtem Messing

		Stück	1	
401 85 07	1	1	64.90	51.92

1/8 l, 83 mm Ø



Radieschenschneider CNS

Radieschenverzierer und Zackenschneider

		Stück	1	
401 82 18	1	1	27.00	24.30

18 cm



Apfel- und Birntenteiler

Mit einem Druck 12 gleiche Stücke und Entfernung des Kerngehäuses

		Stück	1	
401 83 17	1	1	19.90	17.91

17 x 11 cm



Küchenspachtel

Edelstahl, rostfrei, Länge ohne Griff

		Stück	1	
410 30 23	1	1	24.00	21.60
410 67 25	1	1	12.00	10.80

23 X 3.2 cm

12 x 10 cm



Küchenspachtel

Edelstahl, rostfrei, Länge jeweils ohne Griff

		Stück	1	
410 31 16	1	1	24.00	21.60
410 32 11	1	1	29.00	26.10

Gekröpft, 16 x 5 cm

Gekröpft, 11 x 8 cm



Küchenspachtel

		Stück	1	
410 33 25	1	1	17.00	15.30
410 34 25	1	1	16.00	14.40

Gekröpft, 25 x 7.6 cm

Gekröpft, gelocht, 25 x 7.6 cm



Tomaten- und Gemüschäler

Auch für Peperoni und Kiwi geeignet

		Stück	1	
410 24 00	1	1	4.40	3.96

15 cm



Sparschäler

Edelstahl, rostfrei

		Stück	1	
410 16 00	1	1	5.40	4.86
410 35 00	1	1	3.00	2.70

zweischneidig

Sparschäler CNS



Sparschäler CNS

Schälen ohne Unordnung. Die Schale wird nach hinten weggeführt und fällt direkt in das bereitgestellte Abfallgeschirr

		Stück	1	
410 23 00	1	1	13.00	11.70

CNS 18/10, 6 cm

Küche



Tranchiermesser

	Stück	1	
			10 %
410 00 20	1	1	56.00 50.40
Kullenschliff, 20 cm			
410 00 22	1	1	34.00 30.60
22 cm			
410 00 25	1	1	41.00 36.90
25 cm			



Santoku-Messer

	Stück	1	
			10 %
410 44 17	1	1	44.00 39.60
Kullenschliff, 17 cm			
410 43 17	1	1	38.00 34.20
17 cm			



Tranchierbesteck

	Stück	1	
			10 %
410 02 18	1	1	45.00 40.50
Tranchiergabel, 18 cm			
410 03 25	1	1	76.00 68.40
Kochmesser, 25 cm			



Kochmesser, geschmiedet

	Stück	1	
			10 %
410 03 25	1	1	76.00 68.40
Kochmesser, 25 cm			



Küchenmesser

	Stück	1	
			10 %
410 15 12	1	1	21.00 18.90
12 cm			



Tranchiergabel

	Stück	1	
			10 %
410 01 18	1	1	51.00 45.90
18 cm			



Schlacht- und Bankmesser

	Stück	1	
			10 %
410 41 28	1	1	47.00 42.30
28 cm			



Ausbeinmesser

Edelstahl, rostfrei

	Stück	1	
			10 %
410 04 18	1	1	28.00 25.20
18 cm			



Filetmesser

Edelstahl, rostfrei

	Stück	1	
			10 %
410 05 18	1	1	26.00 23.40
18 cm			



Konditorsäge

Edelstahl, rostfrei

	Stück	1	
			10 %
410 06 26	1	1	37.00 33.30
26 cm			



Brotmesser Gastronomie

Edelstahl, rostfrei

	Stück	1	
			10 %
410 07 21	1	1	12.00 10.80
21 cm			



Lachsmesser

Edelstahl, rostfrei

	Stück	1	
			10 %
410 08 30	1	1	49.00 44.10
30 cm			



Abziehstahl

rund, hartverchromt

	Stück	1	
			10 %
410 09 30	1	1	33.00 29.70
30 cm			



Tomatenmesser

	Stück	1	
			10 %
410 14 11	1	1	4.80 4.32
11 cm			



Rüstmesser

Edelstahl, rostfrei

	Stück	1	
			10 %
410 11 08	1	1	3.60 3.24
glatte Klinge, 8 cm			
410 12 08	1	1	3.60 3.24
Säge-Klinge, 8 cm			



Steakmesser

	Stück	1	
			10 %
152 07 00	6	1	5.40 4.86
Griff: Polypropylen, schwarz, Wellenschliff			



Tourniermesser

	Stück	1	
			10 %
410 13 00	1	1	3.90 3.51
6 cm			



Fleisch-Klopfer

Massiv, rostfrei, 1.1 kg

	Stück	1	
			10 %
410 37 31	1	1	97.00 87.30
33 cm, 14.5 x 9.5 cm			

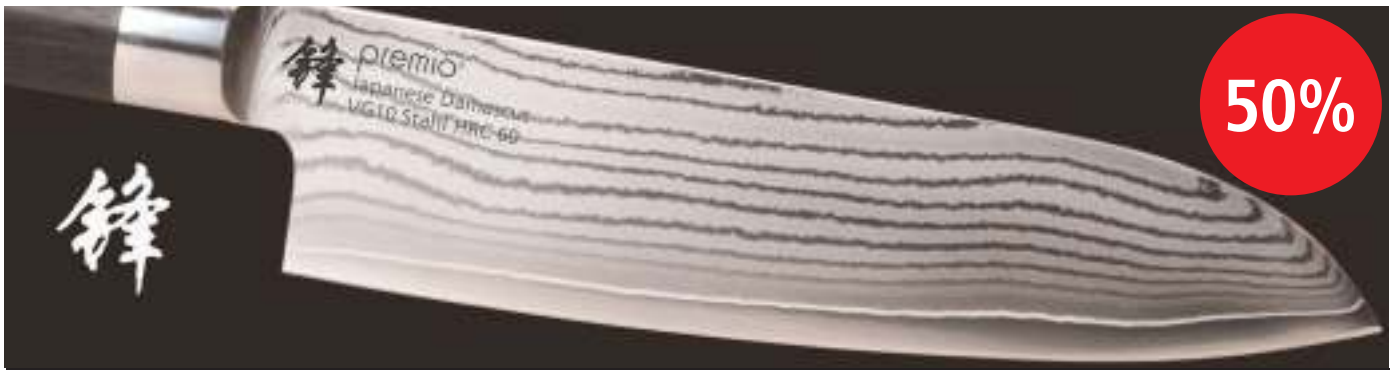

Santoku- und Allzweck premiostar Damast-Messer

Das Premio Santuko- und Allzweck Messer wird in japanischer Tradition aus 67 Lagen Damaszenerstahl gefertigt. Die innerste Lage besteht aus V-Gold-10 Stahl. Durch den Schweißverbund verschiedener Stähle wird ein Messer erzeugt, welches Schnitthaltigkeit, Flexibilität und Korrosionsschutz in optimaler Weise kombiniert. Die Klinge besitzt einen Härtegrad von 60 HRC (Rockwell Härtegrad) und erlaubt ein ermüdungsfreies Arbeiten. Jedes Messer ist ein Unikat und besitzt eine individuelle Maserung. In edler Verpackung mit Magnetverschluss. Für Rechts- und Linkshänder.



Santoku-Damastmesser premiostar

Aus 67 Lagen Damaszenerstahl gefertigt

		Stück		1	
410 99 17	31 cm, Klingenlänge 17.5 cm	1	1	240.00	120.00



Allzweck-Damastmesser premiostar

Aus 67 Lagen Damaszenerstahl gefertigt.

		Stück		1	
410 98 16	31 cm, Klingenlänge 17.5 cm	1	1	178.00	89.00



Universal Dosenöffner

		Stück		1	
420 18 00	18 cm	1	1	41.00	9.90



Tisch-Dosenöffner

Chromnickelstahl, TOP-Dosenöffner, zur Befestigung an der Tischplatte spülmaschinenfest

		Stück		1	
420 17 00	Tisch-Dosenöffner, H: 55 cm	1	1		370.00
420 17 50	Ersatz-Messer	1	1		11.90
420 17 51	Ersatz-Zahnrad	1	1		35.80
420 17 52	Messerhalter mit Niete	1	1		19.50
420 17 55	Messerschrauben	1	3		29.00



Tisch-Dosenöffner Bonzer

Alle Eaziclean ® -Modelle sind NSF-zertifiziert und verfügen über eine patentierte Schnellhalterung des Messerblockes. Mit einem Handgriff wird der Messerblock schnell und einfach entfernt für die bequeme und effiziente Reinigung, zum Beispiel in der Spülmaschine. Das speziell gehärtete Messer und Zahnrad können bei Bedarf schnell und einfach ohne Werkzeug ersetzt werden.

Bonzer Classic: 41 cm, Stab, Abdeckung, Messer und Zahnrad ganz in Edelstahl, Messerblock aus Metall und Handkurbel aus glasfaserverstärktem Kunststoff

Bonzer Canmaster: 64 cm, ganz in Edelstahl mit grossem Zahnrad für einfaches, schnelles Öffnen, Handkurbel aus glasfaserverstärktem Kunststoff

		Stück		1	
420 19 01	Bonzer Classic, für Dosen bis H: 36 cm, 25 Zahnrad mm Ø	1	1	197.00	177.30
420 14 00	Bonzer Canmaster, für Dosen bis H: 56 cm, Zahnrad 40 mm Ø	1	1	398.00	358.20

Küche

Seki Magoroku Vintage

Der genietete Holzgriff und die glanzpolierte Klinge aus 3-Lagen Kohlenstoffstahl mit 59±1 HRC Härte verleihen der Serie ein klassisches Aussehen. Die beiden Griffhälften aus japanischer Birke sind durch 3 Edelstahlnieten fest verbunden

		Stück			1
411 09 15	Allzweckmesser, Klinge: 15 cm, Griff: 9 cm	1	1	419.00	107.10
411 09 17	Santokumesser, Klinge: 16.5 cm, Griff: 10.5 cm	1	1	429.00	116.10
411 09 20	Kochmesser, Klinge: 20 cm, Griff: 10.5 cm	1	1	439.00	125.10
411 09 23	Schinkenmesser, Klinge: 23 cm, Griff: 10.5 cm	1	1	439.00	125.10



Shun-Damastmesser

Shun Profi-Kochmesser werden aus einem speziellen entwickelten, rostfreien Damaszener-Stahl mit 64 Lagen gefertigt. Die innere Lage besteht aus V-Gold-10 Stahl. Dieser Stahl ist äusserst korrosionsbeständig, extrem hart und macht die Klinge unvergleichlich dauerhaft scharf.



Kai Shun Schälmesser

	Stück	1
411 00 09	1	419.00 107.10

16.9 cm

Kai Officemesser

	Stück	1
411 00 10	1	419.00 107.10

19.4 cm

Kai Allzweckmesser

	Stück	1
411 00 01	1	439.00 125.10

25.4 cm



Kai Santoku Küchenmesser

	Stück	1
411 00 02	1	219.00 197.10

28.7 cm

Kai Santoku mit Kullenschliff

	Stück	1
411 00 06	1	229.00 206.10

28.7 cm

Kai Grosses Santoku

	Stück	1
411 00 05	1	279.00 251.10

30.2 cm



Kai Kochmesser

	Stück	1
411 00 04	1	229.00 206.10

32.2 cm

Kai Kochmesser mit Kullenschliff

	Stück	1
411 00 07	1	239.00 215.10

32.2 cm

Kai Klingenschutz

	Stück	1
411 00 52*	1	19.00
411 00 57	1	29.00

Klingenschutz für Klagen bis max. 25x3.5cm
Klingenschutz für Klagen bis max. 24x6cm



Kai Elektrischer Messerschärfer

Der neue elektrische Messerschärfer von Kai ist mit einer neuen Schleifeinheit aus zwei keramischen Schleifeinheiten ausgestattet, welche ein grobes und feines Schleifen (Finish) in einem Arbeitsschritt ermöglichen

	Stück	1
411 00 51	1	119.00

13.8 x 11.1 cm, H: 10.5 cm, 230 V, 60 W



Kai Kombi-Wetzstein

Der DM-0708 bietet mit seinen beiden Seiten eine grobe zum Schleifen und eine feine, um die Schneide zu schärfen

	Stück	1
411 00 50	1	79.00 71.10

DM-0708, Körnung 300/1000, 18.4 x 6.2 cm, H: 2.8 cm



Kai Kombi-Wetzstein

Der DM-0600 bietet dem Profi noch die Möglichkeit, die Schneide auf der 6000er Seite zu polieren

	Stück	1
411 00 54	1	449.00 134.10

DM-0600, Körnung 1000/6000, 18.4 x 6.2 cm, H: 2.8 cm



Spargelschäler

	Stück		1
410 18 17	1	1	4.90
17 cm			



Kartoffelausstecher

	Stück		1
410 22 00	1	1	13.50
15.00 10 %			
22 + 25 mm Ø			



Messer für Weichkäse

	Stück		1
410 25 26	1	1	18.90
21.00 10 %			
Käsemesser mit gelochter Klinge, 25.5 cm			



Käsemesser

Edelstahl, rostfrei

	Stück		1
410 25 12	1	1	4.86
5.40 10 %			
Käsemesser, 22 cm			



Käseschaufel

	Stück		1
410 26 17	1	1	44.82
49.80 10 %			
Käseschaufel, 25 x 18 cm			



Fleischhaken

	Stück		1
410 39 10	10	1	0.99
10 cm, 4 mm Ø			
410 39 14	10	1	1.35
14 cm, 6 mm Ø			



Messerschärfgerät Vulkanus

Schärfen und abziehen in einem. Der patentierte Messerschleifer für glatte Klingen sowie Wellenschliff. Das hochwertige Material garantiert eine rasiermesserscharfe Schneide, lange Lebensdauer, lebensmittelecht und spülmaschinenfest

	Stück		1
410 47 00	1	1	98.00
11 x 9 cm, H: 15.5 cm			



Magnetischer Messerhalter

Balken aus grauem Kunststoff mit 2 extra-starken Magnetleisten

	Stück		1
410 38 30	1	1	16.00
20.00 20 %			
34 cm			



Messereinsatz für Schubladen GN 1/1

einstellbar auf verschiedene Messergrößen, ohne GN-Behälter

	Stück		1
410 66 11	1	1	179.10
199.00 10 %			
Einsatz, GN: 1/1, 48 x 28 cm, H: 4 cm			
	Stück		1
423 10 10	1	1	18.60
Behälter PP, GN: 1/1, 53 x 32.5 cm, H: 10 cm			



Messereinsatz GN 1/1 für Schubladen

Kunststoff braun, 2 Abteilungen für Küchenmesser und Kellen

	Stück		1
410 65 00	1	1	92.40
132.00 30 %			
52 x 30 cm, H: 8.5 cm			



Koch-Messerkoffer

14-teilig

	Stück		1
410 40 14	1	1	512.55
603.00 15 %			
31 x 49 cm, H: 8 cm			



Koch-Messerkoffer

45-teilig

	Stück		1
410 40 45	1	1	906.95
1067.00 15 %			
35 x 51 cm, H: 8 cm			

Küche



Eimer

CNS 18/10, ohne Deckel, mit Fussreif

	Stück		1
401 68 10	1	435.00	121.50 10 %
10 l, 24 cm Ø, H: 26 cm			
401 68 12	1	272.00	244.80
12 l, 24 cm Ø, H: 29 cm			
401 68 15	1	258.00	232.20
15 l, 27 cm Ø, H: 30 cm			
	Stück		1
401 69 24	1		56.00
Deckel, 24 cm Ø			
401 69 27	1		66.00
Deckel, 27 cm Ø			



Master Pour, mit Ausgiesser

Behälter mit Ausgiesser und Deckel, nur komplett erhältlich

	Stück		1
310 29 15	1	7.10	6.39 10 %
gelb, 1 l			
310 29 25	1	7.10	6.39
orange, 1 l			
310 29 45	1	7.10	6.39
rot, 1 l			
310 29 55	1	7.10	6.39
grün, 1 l			
310 33 15	1	7.80	7.02
gelb, 2 l			
310 33 25	1	7.80	7.02
orange, 2 l			
310 33 45	1	7.80	7.02
rot, 2 l			
310 33 55	1	7.80	7.02
grün, 2 l			



Quetschflasche

Ideal um Teller mit Saucen zu verzieren, mit Verschlusskappe

	Stück		1
310 48 02	1	2.30	1.84 20 %
0.2 l, 5 cm Ø, H: 18 cm			
310 48 04	1	3.90	3.12
0.35 l, 5.5 cm Ø, H: 19 cm			
310 48 07	1	4.40	3.28
7 cm Ø, H: 24 cm, 0.7 l			
310 48 15	1	4.40	3.28
gelb, 7 cm Ø, H: 24 cm, 0.7 l			



Eimer

CNS 18/8, mit Masseinteilung, Fussreifen und Henkel

	Stück		1
401 67 12	1	412.00	100.80 10 %
12 l			



Messbecher Polypropylen

	Stück		1
403 00 28	1	9.90	7.92 20 %
1.0 l, 12.5 cm Ø			
403 00 29	1	17.20	13.76
2.0 l, 13.5 cm Ø			
403 00 30	1	18.80	15.04
3.0 l, 15.5 cm Ø			
403 00 31	1	19.90	15.92
5.0 l, 19 cm Ø			



Küchenmass

CNS 18/8

	Stück		1
401 60 10	1	18.00	14.40 20 %
Skala: 0.5, 10 dl, 1 l			
401 60 20	1	35.00	28.00
Skala: 0.5, 10, 20 dl, 2 l			



Masseimer mit Ausguss

CNS 18/10, mit Masseinteilung, Fussreifen

	Stück		1
401 70 10	1	427.00	384.30 10 %
10 l, 24 cm Ø, H: 26 cm			
401 70 15	1	460.00	414.00
15 l, 27 cm Ø, H: 30 cm			



Universalscheren

Edelstahl, rostfrei, Mikrowellenschliff, rutschfeste Softgrip-Griffe

	Stück		1
410 29 17	1		9.50
16.5 cm			
410 29 21	1		12.90
21 cm			



Hotel- und Restaurant-Apotheke

Kunststoffkoffer rot mit Rotkreuzkleber, Apotheke speziell für das Gastgewerbe ausgerüstet, abschliessbar, Inhalt 40-teilig, Apotheke vollständig, mit Wandhalterung

	Stück		1
800 45 00	1	249.00	224.10 10 %
34 x 24 cm, H: 12 cm			

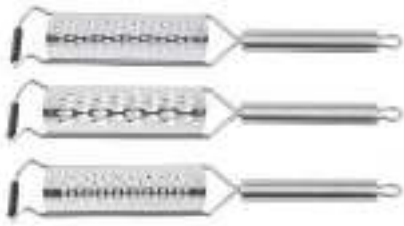

Reiben Ultrascharf

Rasierklingenscharfe, langlebige Klinsen durch Lasertechnologie, Sicherheits-Abdeckung, Reibe 6.5 x 13.5 cm, 32.5 cm Gesamtlänge

	Stück		1
			20 %
401 93 00	1	1	18.00 14.40
Reibe fein			
401 93 01	1	1	18.00 14.40
Kartoffelreibe			
401 93 02	1	1	18.00 14.40
Gemüseraspel			



Reiben Ultrascharf

Rasierklingenscharfe, langlebige Klinsen durch Lasertechnologie, Sicherheits-Abdeckung, Reibe 6.5 x 13.5 cm, 32.5 cm Gesamtlänge

	Stück		1
			20 %
401 93 03	1	1	18.00 14.40
Gemüsehobel			
401 93 04	1	1	18.00 14.40
Käse-/Schoko-Reibe			
401 93 05	1	1	4.00 3.20
Resthalter			



Raffeln

Edelstahl 18/0, massiv, mit Antirutschringen, spülmaschinenfest, 30 x 11 cm

	Stück		1
			20 %
402 00 01	1	1	13.00 10.40
Bircherraffel			
402 00 02	1	1	13.00 10.40
Käse-, Zitrusraffel			
402 00 03	1	1	13.00 10.40
Gemüsereibe			
402 00 04	1	1	13.00 10.40
Kartoffel-/Gurkenhobel			



Raffeln

18/10 CNS, massiv, mit Antirutschringen, spülmaschinenfest, 29 x 11 cm

	Stück		1
401 89 01*	1	1	34.90
Bircherraffel			
401 89 03*	1	1	34.90
Röstraffel breit			



Trüffel- und Gourmet Hobel

Trüffelschneider aus Olivenbaumholz, Klinge aus rostfreiem, gehärtetem Stahl

	Stück		1
			10 %
401 82 01	1	1	55.00 49.50
Klinge 6 cm			



Gemüseschneider Spinnrad

Der robuste, handliche Gemüse-/Salat-Schneider schneidet mühelos Streifen (Spaghetti-Rösti) und Spiralen. Gehäuse und Schlitten aus rostfreiem Stahl, auseinandernehmbar für die leichte Reinigung, Messerhalterung aus Aluminiumguss

	Stück		1
401 45 00	1	1	299.00
37 x 14 cm, H: 25 cm			

108.-



Gemüseschneider Mandoline CNS

Komplett mit 7 verschiedene Klinsen, Anti-Rutsch-Gestell, Schutzabdeckung, Klinsenbreite 10 cm

	Stück		1
			20 %
401 99 00	1	1	135.00 108.00
40.5 x 12 cm			



Gemüseschneider Mandoline Ultra

Neu mit Würfelschnitt - in einem Arbeitsgang Würfel 2, 4 und 10 mm herstellen. Mandoline mit Wagen und Chassis (Handschutz) mit 2 horizontalen Klinsen (glatt und gewellt) und 3 Julienne Klinsen 2/4/10 mm

	Stück		1
			20 %
401 92 00	1	1	239.00 191.20
50 x 18.5 cm			



Gemüseschneider Mandoline Viper

Mandoline mit V-förmiger Klinge mit Wagen und Chassis (Handschutz), 1 horizontaler Klinge, 2 Julienne Klinsen 2 und 4 mm, mit Würfelschnitt

	Stück		1
			20 %
401 98 00	1	1	226.00 180.80
41 x 21 cm			

Küche

Kühlthermometer drehbar

+45 bis -50° C



420 03 00	21 x 2.2 cm	Stück	1	1	4.20
------------------	-------------	-------	---	---	------

Einstich-Infrarot-Thermometer

Wahlweise messen mit Infrarot oder Einsteckfühler, Infrarotmessung von -33 bis +220° C +/- 1° C, Einsteckfühler von -55 bis +330° C +/-1° C, mit Kalibrierschein



420 08 00	28 x 3.7 cm	Stück	1	1	212.90
------------------	-------------	-------	---	---	--------

Elektronischer Küchen-Thermo-Timer

Für die Lebensmittelzubereitung, Alarm bei Erreichen einer einstellbaren Temperaturvorgabe (Ober- und Untergrenze), Edelstahlsonde (160 mm) mit hitzebeständigem Kabel, ideal als Bratenthermometer, Max./Min.-Funktion, Messbereich -10 bis +200°C (12/24 h), Timer (bis 24h), Stoppuhr, Befestigungsmagnet, aufstellbares Display, inkl. Batterie



420 06 00	120 x 67 mm	Stück	1	1	60.00 48.00
------------------	-------------	-------	---	---	------------------------

Messpistole mit Laservisier

Messpistole mit Laservisier, exaktes, berührungsloses Messen mit Digitalanzeige von -35 bis +365° C



420 10 00	16.5 x 6.5 cm	Stück	1	1	166.00 116.20
------------------	---------------	-------	---	---	--------------------------

Salatschleuder manuell

Kunststoff mit Schleudereinsatz, Ablaufhahn, Handbetrieb für frischen, knackigen Salat, spart Sauce, da das Dressing besser am Salat haftet. Salat eiskalt waschen, schleudern und dann kaltstellen



420 11 43	25 l, 43 cm Ø, H: 52 cm	Stück	1	1	285.00 199.50
------------------	-------------------------	-------	---	---	--------------------------

Passetout

Edelstahl 18/10, schwere Qualität, mit einem seitlichen Griff, geliefert mit drei auswechselbaren Klingenstahleinsätzen (Ø 14 cm), geeignet für Topf-Ø 16-20 cm

Mit drei Einsatzscheiben Loch-Ø 1,5 mm, 2,5 mm und 4 mm



401 58 00	31 cm Ø, 1.4 kg	Stück	1	1	215.00 172.00
------------------	-----------------	-------	---	---	--------------------------



primiStar

Schneideplatten

ohne Safrillen
 braun = Gekochtes/Wurstwaren
 weiss = Milchprodukte/Brot
 gelb = Geflügel
 grün = Gemüse/Früchte
 blau = Fisch
 rot = rohes Fleisch

			Stück		1 30 %
GN 1/2					
410 52 00	weiss, GN: 1/2, 265 x 325 mm, H: 20 mm	1	1	28.00	19.60
410 52 15	gelb, GN: 1/2, 265 x 325 mm, H: 20 mm	1	1	28.00	19.60
410 52 45	rot, GN: 1/2, 265 x 325 mm, H: 20 mm	1	1	28.00	19.60
410 52 55	grün, GN: 1/2, 265 x 325 mm, H: 20 mm	1	1	28.00	19.60
410 52 65	blau, GN: 1/2, 265 x 325 mm, H: 20 mm	1	1	28.00	19.60
410 52 85	braun, GN: 1/2, 265 x 325 mm, H: 20 mm	1	1	28.00	19.60
GN 1/1					
410 53 00	weiss, GN: 1/1, 530 x 325 mm, H: 20 mm	1	1	55.00	38.50
410 53 15	gelb, GN: 1/1, 530 x 325 mm, H: 20 mm	1	1	55.00	38.50
410 53 45	rot, GN: 1/1, 530 x 325 mm, H: 20 mm	1	1	55.00	38.50
410 53 55	grün, GN: 1/1, 530 x 325 mm, H: 20 mm	1	1	55.00	38.50
410 53 65	blau, GN: 1/1, 530 x 325 mm, H: 20 mm	1	1	55.00	38.50
410 53 85	braun, GN: 1/1, 530 x 325 mm, H: 20 mm	1	1	55.00	38.50
GN 2/1					
410 54 00	weiss, GN: 2/1, 650 x 530 mm, H: 20 mm	1	1	98.00	68.60
410 54 15	gelb, GN: 2/1, 650 x 530 mm, H: 20 mm	1	1	98.00	68.60
410 54 45	rot, GN: 2/1, 650 x 530 mm, H: 20 mm	1	1	98.00	68.60
410 54 55	grün, GN: 2/1, 650 x 530 mm, H: 20 mm	1	1	98.00	68.60
410 54 65	blau, GN: 2/1, 650 x 530 mm, H: 20 mm	1	1	98.00	68.60
410 54 85	braun, GN: 2/1, 650 x 530 mm, H: 30 mm	1	1	98.00	68.60



primiStar

Set
245.-

hulu Schneideplatten-Set

Bestehend aus 5 Schneideplatten GN 1/1, 20 mm weiss, grün, rot, gelb, blau, eine Schneideplatte GN 1/1 braun 30 mm mit Safrille; inklusive Gestell verchromt

			Stück		1 30 %
410 56 00	Set 7-Teile	1	1	350.00	245.00



primiStar

Schneideplatten-Gestell

Verchromter Draht, für 6 Schneideplatten

			Stück		1 50 %
410 55 00	35.5 x 27 cm, H: 17 cm	1	1	58.00	29.00



primiStar

Wandhalterung

für 5 Schneideplatten bis 20 mm

			Stück		1 30 %
410 82 05		1	1	119.00	59.50

Küche

hulu Schneideplatten mit Saftrillen

Aus Polyethylen

Unempfindlich gegen Säuren und Chemikalien, schlagzäh, Einsatztemperaturen -200 °C bis +80 °C, spülmaschinenfest, umweltverträglich, lebensmittelgerecht

		Stück			
					1
					30 %
410 50 00	weiss, GN: 1/2, 325 x 265 mm, H: 20 mm	1	1	36.60	25.62
410 50 85	braun, GN: 1/2, 325 x 265 mm, H: 20 mm	1	1	34.00	23.80
410 51 85	braun, GN: 1/1, 530 x 325 mm, H: 30 mm	1	1	60.00	42.00



Andere Grössen auf Anfrage

Schneidebrett Prof board GN 1/1

Basisbrett mit Schneideblätter in weiss, gelb, rot, grün, blau und schwarz, GN 1/1, aus Polyethylen, Füsse aus rostfreiem Edelstahl mit Gummiauflagen. Alle Teile spülmaschinengeeignet, Schneideblätter können durch einfaches Einklicken in den Ecken ausgewechselt werden, Schneideblätter: Packung à 5 Stück

		Stück			
					1
					10 %
410 58 11	Set 7-Teile, GN: 1/1, 530 x 325 mm	1	1	149.00	134.10
410 59 00	Schneideblätter weiss, GN: 1/1, 530 x 325 mm	1	5		25.00
410 59 15	Schneideblätter gelb, GN: 1/1, 530 x 325 mm	1	5		25.00
410 59 45	Schneideblätter rot, GN: 1/1, 530 x 325 mm	1	5		25.00
410 59 55	Schneideblätter grün, GN: 1/1, 530 x 325 mm	1	5		25.00
410 59 65	Schneideblätter blau, GN: 1/1, 530 x 325 mm	1	5		25.00



Barschneidebrett

Für Buffets und Bars

		Stück			
					1
310 58 00	22 x 14 cm, H: 0.8 cm	1	1		16.80



Hackstock mit Messerhalter braun

Hackstock komplett mit Block-Oberteil und Messerhalter

		Stück			
					1
					20 %
410 76 00	Hackstock komplett, 40 x 40 cm, H: 90 cm	1	1	850.00	680.00
410 76 50	Ersatz-Block-Oberteil, 40 x 40 cm, H: 5 cm	1	1	120.00	96.00



680.-

Hackstock-Folie Flip-Flap

		Stück			
					1
410 75 50	Hackstockfolien-Halter CNS	1	1		169.00
410 75 00	Folie, Rolle à 15 m	1	7		69.00



Schneideplatten-Hobel

Die zerschnittene und verschmutzte Oberfläche der Arbeitsplatte wird mit diesem Hobel abgetragen; es entsteht eine saubere, glatte Oberfläche.

		Stück			
					1
					20 %
410 61 00	Schneideplatten-Hobel	1	1	110.00	88.00
410 61 50	Ersatz Klinge	1	1	24.00	19.20





Stabmixer Bamix Gastro 200/350

Für kurze Betriebszeiten bis 5 Minuten, inkl. Spiralkabel, Multimesser, Schlagscheibe, Quirl und Wandmixer, Wandhalterung

			Stück		1
430 05 00	Bamix 200, Eintauchtiefe: 25 cm, 39.5 cm, 12000 + 18000 U/Min, 230 V, 200 W, 1 kg	1	1	265.00	198.75 25 %
430 05 10	Bamix 350, Eintauchtiefe: 35 cm, 49.5 cm, 18000 + 22000 U/Min, 230 V, 350 W, 1.2 kg	1	1	399.00	299.25



Stabmixer Kisag

Profi Stabmixer inkl. Wandhalterung

- Stab, Fuss und Messer in Edelstahl
- 2 Geschwindigkeitsstufen

			Stück		1
432 43 20	Stabmixer, 20 cm, 20'000/15'000 U/Min, 230 V, 250 W, 1.83 kg	1	1	289.00	231.20 20 %
432 43 40	Stabmixer, 40 cm, 17'000/14'000 U/Min, 230 V, 250 W, 5.1 kg	1	1	795.00	636.00
432 43 50	Stabmixer, 50 cm, 17'000 / 14'000 U/Min, 230 V, 550 W, 4 kg	1	1	890.00	712.00



Stabmixer Robot-Coupe

Robustes Profi-Gerät leicht und ergonomisch

- Stab, Mischkopf und Messer aus Edelstahl
- Stufenlos

			Stück		1
430 03 17	Stabmixer, 16.5 cm, 1500 - 14000 U/Min, 230 V, 220 W, 1.4 kg	1	1	229.00	206.10 10 %
430 03 45	Stabmixer, 45 cm, 1500 - 9000 U/Min, 230 V, 500 W, 5 kg	1	1	759.00	683.10
430 04 45	Stabmixer/Rührbesen, 45 cm, 1500 - 9000 U/Min, 230 V, 500 W, 6.1 kg	1	1	1071.00	963.90



Stabmixer Rotor

Robustes Profi-Gerät leicht und ergonomisch

- Stab, Mischkopf und Messer aus Edelstahl

			Stück		1
430 00 25	Stabmixer, 25 cm, 9000 U/Min, 230 V, 250 W, 1.4 kg	1	1	350.00	315.00 10 %
430 00 40	Stabmixer inkl. Wandhalterung, stufenlos, 40 cm, 4050 - 8500 U/Min, 230 V, 450 W, 3.6 kg	1	1	655.00	589.50
430 01 40	Stabmixer/Rührbesen, 40 cm, 4050 - 8500 U/Min, 230 V, 450 W, 4.4 kg	1	1	965.00	868.50

Küche



Pacojet 2

Pacojet 2 ist die neue Geräte-Generation, mit der aus einfachen Zubereitungen kulinarische Spitzenleistungen entstehen. Das Pacossieren ermöglicht Köchen, frische, tiefgefrorene Lebensmittel ohne Auftauen zu «mikropürieren», um ultra-leichte Mousses, naturfrische Eiscremes und Sorbets oder aromatische Suppen, Saucen und Füllungen herzustellen. Intensive Aromen, natürliche Farben und vitale Nährstoffe bleiben in den servier fertigen Portionen erhalten.

Das Pacojet 2 System enthält:

- 1 Pacojet 2 Maschine
- 1 Spritzschutz
- 1 Schutzbecher
- 1 Bedienungsanleitung
- 1 Reinigungseinsatz (blau)
- 1 Pacossierflügel
- 2 Pacossierbecher mit Deckel
- 1 Spatel aus Chromstahl
- 1 Internationales Rezeptbuch
- 1 Becherdichtung (blau) • 1 Spüleinsatz (grün)



Pacojet 2

		Stück	Stück		1
432 90 02	18.2 x 36 cm, H: 49.8 cm, 230 V, 950 W, 15.7 kg	1	1	4950.00	4702.50
432 90 50	Pacossierbecher CNS mit Deckel	1	10		400.00
432 90 52	Pacossierflügel Standard	1	1		149.00
432 90 55	Pacojet Pacossiermesser "Gold"	1	1		189.00
001 96 55	Pacojet 2 Coupe Set	1	1		345.00



Pacojet Junior

Pacojet Junior ist das jüngste Mitglied der Pacojet Produktfamilie mit dem aus einfachen Zubereitungen kulinarische Spitzenleistungen entstehen. Mit dem Pacojet Junior wird das Angebot um ein Einsteigermodell erweitert, das sich ausschliesslich auf die Grundfunktion, das Pacossieren frischer, tiefgefrorener Lebensmittelzubereitungen, konzentriert. Der Pacojet Junior ist auch hervorragend als Zweitgerät einsetzbar. Ein Ausbau des Wirkungsradius, z.B. mit dem Coupe Set ist nicht möglich

Das Pacojet Junior System enthält:

- 1 Pacojet Junior Maschine
- 1 Spritzschutz
- 1 Schutzbecher
- 1 Bedienungsanleitung
- 1 Reinigungseinsatz (blau)
- 1 Pacossierflügel
- 1 Pacossierbecher mit Deckel
- 1 Spatel aus Chromstahl
- 1 Internationales Rezeptbuch
- 1 Becherdichtung (blau) • 1 Spüleinsatz (grün)

Pacojet Junior

		Stück	Stück		1
432 89 01	blau, 18.2 x 36 cm, H: 49.8 cm, 230 V, 1000 W, 12.9 kg	1	1	3295.00	3130.25
432 89 02	orange, 18.2 x 36 cm, H: 49.8 cm, 230 V, 1000 W, 12.9 kg	1	1	3295.00	3130.25
432 90 50	Pacossierbecher CNS mit Deckel	1	1		400.00
432 90 52	Pacossierflügel Standard	1	1		149.00
432 90 55	Pacojet Pacossiermesser "Gold"	1	1		189.00



ROTOR**Küchenmixer Rotor GK900**

Rotor Gastronom GK900 - Speziell entwickelt für die gewerbliche Küche. Der Mixer verfügt über 900W Dauerleistung, kann aber kurzzeitig sogar ca. 1600W leisten und ist dennoch sehr leise. Die Drehzahl ist stufenlos einstellbar. Der obere Teil des Motorsockels wurde so konstruiert, dass die Reinigung möglichst einfach ist. Selbstverständlich verfügt dieses Modell auch über eine Schutzvorrichtung mit Überwachung des Deckels, wie dies für gewerbliche Küchenmixer vorgeschrieben ist. Swiss made

		Stück			1
430 12 20	Motorsockel GK900, 230 V, 900 W, ~1600 W, 5.1 kg	1	1	905.00	814.50 10 %
430 10 54	Mixaufsatz Polycarbonat stapelbar, 2 l	1	1	170.00	153.00
430 12 50	Mixaufsatz Polycarbonat, 4 l	1	1	360.00	324.00
430 12 51	Mixaufsatz CNS, 2 l	1	1	360.00	324.00
430 12 52	Mixaufsatz CNS, 4 l	1	1	530.00	477.00

1161.-**Cutter Robot-Coupe R2**

Platzsparender und kleiner Tischcutter, optimal für grobes und feines Hacken, Emulgieren, Verrühren, Zerkleinern und Kneten
Gehäuse und Deckel aus Polycarbonat
2.9 Liter Aufsatz aus CNS

		Stück			1
431 29 00	R2, einstufig 1'500U/min, 2.9 l, 28 x 20 cm, H: 35 cm, 230 V, 550 W, 10 kg	1	1	1290.00	1161.00 10 %

**Cutter Robot-Coupe R4 VV**

Leistungsfähiger Tischcutter, optimal für grobes und feines Hacken, Emulgieren, Verrühren, Zerkleinern und Kneten
Metallgehäuse, Deckel aus Polycarbonat
4.5 Liter Aufsatz aus CNS

		Stück			1
431 29 02	R4 VV, stufenlos 300 - 3'500 U/min, 4.5 l, 22.6 x 22.6 cm, H: 46 cm, 230 V, 1000 W, 15 kg	1	1	2553.00	2297.70 10 %

NEW**Gemüseschneider inkl. Schneidscheiben**

Gehäuse aus Edelstahl, Gemüse, Obst oder Käse – leistungsstarker Gemüseschneider inklusive 3 Schneidscheiben und einem besonders grossen Einfüllschacht., Einfüllschächte: 1 x 115 x 75 mm, 1 x Ø 52 mm, Magnetschalter für Auffangbehälter und Einfüllschute, Schutzart: IPX3, Ein-/Ausschalter mit Kontrollleuchte

Inklusive:

- 1 Schneidscheibe (Scheiben, 2 mm)
- 1 Schneidscheibe (Stäbchen / Julienne, 4 mm)
- 1 Schneidscheibe (Raspel, 4 mm)
- 1 Auffangbehälter (1/3 GN, 175 mm tief)
- 1 Stopfer

Weitere Scheiben sind als Zubehör erhältlich

		Stück			1
432 77 00	B x T: 29 x 53 cm, H: 51.5 cm, 230 V, 617 W, 18.25 kg	1	1		1820.00
432 76 50	Scheibenständer (ohne Schneidscheiben)	1	1		39.00

Gemüseschneider Rotor Varimat und Gourmet Inox

Neu - alles aus rostfreiem Edelstahl! Alle Teile mit Lebensmittelkontakt sind spülmaschinen geeignet - Hygiene ohne Zeitaufwand!

Optimaler Schnitt für schonende Verarbeitung, stufenlos regulierbar, grosser Einfüllschacht, pflegeleicht, hygienisch. Swiss made. Ohne Schneidscheiben

Gourmet:

Die Variante Rotor Varimat Inox Gourmet basiert auf der gleichen Maschine, verfügt aber über einen Deckel mit angetriebenem, drehbarem Einsatz im Rundschacht. Mit Hilfe dieser Einrichtung lassen sich zusätzlich die Spezialschnitte Gaufrettes (Waffeln) oder Brunoise (kleine Würfel) schneiden.



Gemüseschneider Rotor Varimat Inox

270 - 750 U/Min
530 x 270 mm, Höhe: 550 mm

	Stück	1	10 %
430 19 00 Varimat Inox, 230 V, 400 W, 18 kg	1	1	3190.00 2871.00

Gemüseschneider Rotor Gourmet Inox

270 - 750 U/Min
Zusätzlich mit Brunoise und Gaufrette
530 x 270 mm, Höhe: 550 mm

	Stück	1	10 %
430 19 10 Varimat Gourmet Inox, 230 V, 400 W, 21 kg	1	1	3590.00 3231.00

Scheibensatz Rotor Varimat

CNS mit Messerstahl:
 • Schneidscheibe CNS verstellbar 0.5 - 8 mm
 • Julienne 2 x 2 mm
 • Raffel R 1.5 mm, 3 mm, 9 mm

	Stück	1	10 %
430 20 55 Varimat CNS	1	1	1261.00 1134.90
430 20 51 Scheibenständer	1	1	150.00

Scheibensatz Varimat und Gourmet

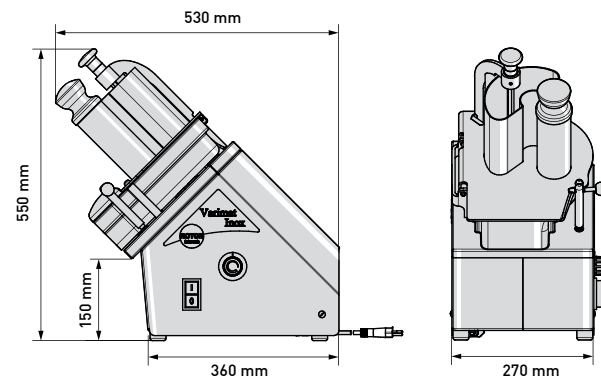

Scheibensatz Rotor Gourmet

CNS mit Messerstahl:
 • Schneidscheibe CNS verstellbar 0.5 - 8 mm
 • Julienne 2 x 2 mm
 • Raffel R 1.5 mm, 3 mm, 9 mm
 • Brunoise 2 x 2 mm
 • Gaufrette G 4 mm

	Stück	1	10 %
430 20 65 Varimat Gourmet CNS	1	1	1794.00 1614.60

Gourmet



ROTOR

Rotor Universal-Küchenmaschine Teddy T5

Kompakte Knetmaschine für den semi-professionellen Einsatz. Geeignet für max 800 - 1000g Mehl.

		Stück		1 10 %
431 04 05	24 x 46.2 cm, H: 40 cm, 230 V, 500 W, 22 kg	1	1	1440.00 1296.00

ROTOR

Spiral-Knetmaschinen Rotor

Profigerät mit aufklappbarem Kopf, fahrbar auf Rollen, abnehmbarem Kessel und Werkzeug, Timersteuerung und 2 Geschwindigkeitsstufen, Nottaste

		Stück		1 10 %
431 15 16	16 l, 68 x 35 cm, H: 85 cm, 400 V, 800 W, 76 kg	1	1	3140.00 2826.00
431 15 22	22 l, 70 x 39 cm, H: 85 cm, 400 V, 800 W, 77 kg	1	1	3260.00 2934.00
431 15 35	35 l, 78 x 43 cm, H: 95 cm, 400 V, 1500 W, 116 kg	1	1	3840.00 3456.00

ROTOR

Rotor Universal-Küchenmaschine RN10 VL-2

Die 10-Liter Profimaschine aus CNS inklusive Besen, Knethaken und Rührer, programmierbare elektronische Steuerung mit Überlastschutz, einfache Bedienung

		Stück		1 10 %
431 07 10	59.2 x 36.9 cm, H: 63.9 cm, 230 V, 700 W, 60 kg	1	1	4650.00 4185.00
431 06 50	Coupe-légumes	1	1	1070.00 963.00
430 20 55	Varimat en inox, Disque à trancher réglable 0.5-8 mm, Julienne 2x2 mm, Râpe 1.5 mm/3 mm/9 mm	1	1	1261.00 1134.90
431 07 53	Hachoir à viande INOX, disques perforés 3, 5, 8 mm	1	1	1290.00 1161.00

ROTOR

Rotor Universal-Küchenmaschine RN20 VL-2

Die 20-Liter Profimaschine aus CNS inklusive Besen, Knethaken und Rührer, programmierbare elektronische Steuerung mit Überlastschutz, einfache Bedienung

		Stück		1 10 %
431 08 20	66.7 x 45 cm, H: 88.5 cm, 230 V, 1200 W, 108 kg	1	1	6690.00 6021.00
431 08 50	Gemüseschneider	1	1	1110.00 999.00
430 20 55	Schneidscheibe verstellbar 0.5-8 mm, Julienne 2x2 mm, Raffel 1.5 mm/3 mm/9 mm, Varimat CNS	1	1	1261.00 1134.90
431 08 60	Fleischwolf, mit Vorschneider, inkl. 3 Lochscheiben 3, 5, 8mm	1	1	1590.00 1431.00

Küche

Pastmaschine Manuell Imperia

Stundenherstellung ca. 12 kg
Breite der Walze und des Walzwerkes 21 cm, Getriebe aus gefrästem und gehärtetem Stahl, drehbarer Einstellknopf mit Zahlen für 10 verschiedene Stärken des Nudelteiges, patentierte Befestigung für einen perfekten Halt auf der Arbeitsfläche
Lieferung ohne Schneidewalzen

		Stück	1	
430 16 00	38 x 32 cm, H: 32 cm, 10.3 kg	1	1	830.00 664.00 20 %



Pastmaschine Elektrisch Imperia

Stundenherstellung ca. 12 kg
Breite der Walze und des Walzwerkes 21 cm, Getriebe aus gefrästem und gehärtetem Stahl, drehbarer Einstellknopf mit Zahlen für 10 verschiedene Stärken des Nudelteiges, patentierte Befestigung für einen perfekten Halt auf der Arbeitsfläche
Lieferung ohne Schneidewalzen

		Stück	1	
430 17 00	30 x 22 cm, H: 25 cm, 230 V, 290 W, 14.8 kg	1	1	2080.00 1664.00 20 %



Schneidewalzen zu Pastmaschine Imperia

		Stück	1	
430 17 50	Spaghetti 2 mm Ø	1	1	181.00 144.80 20 %
430 17 51	Capelli d'Angelo 1.5 mm	1	1	181.00 144.80
430 17 52	Tagliatelle 2 mm	1	1	181.00 144.80
430 17 53	Trenette 4 mm	1	1	181.00 144.80
430 17 54	Fettuccine 6.5 mm	1	1	181.00 144.80
430 17 55	Lasagnette 12 mm	1	1	181.00 144.80



Nudelkocher PASTA

Edelstahl, einfache Bedienung und leichte Reinigung, Beckeninhalt: 7 Liter, Temperaturbereich bis 110° C
inkl. 1 Korb (21 x 23.5 cm, H: 13.5 cm)

		Stück	1	
431 24 00	27 x 42 cm, H: 30 cm, 230 V, 3 kW, Stecker Typ: 23	1	1	540.00
431 24 50	Ersatzkorb klein, 10 x 13.8 cm, H: 13.5 cm	1	1	58.00
431 24 51	Ersatzkorb gross, 21 x 23.5 cm, H: 13.5 cm	1	1	96.00



540.-

Teigwaren-Einsätze CNS 18/10

Für Kochtöpfe ab 36 cm Ø

		Stück	1	
400 37 00	mit Fiberglasgriff, H: 23 cm	1	1	54.00 43.20 20 %
400 38 00	5.5 l, H: 23 cm	1	1	78.00 62.40



Elektro-Wärmeplatte

Für GN 1/1 und GN 2/1, Gehäuse Aluminium, Oberfläche Glas, Ein/Aus-Schalter, Oberflächentemperatur max. 95° C, stufenlose Temperaturregelung von 30° - 95° C, mit Kontrolllampe

		Stück	1	
250 51 11	für GN 1/1, 57 x 30.5, H: 4 cm, 150 W, 1 NAC 230 V, 3.45 kg	1	1	169.00
250 51 21	für GN 2/1, 66.6 x 55, H: 4 cm, 300 W, 1 NAC 230 V, 6.1 kg	1	1	230.00



ab 169.-



Gaskocher Powerfire

Leistungsstarkes Gasrechaud mit Piezo-Zündung, Flamme stufenlos regulierbar, Brenndauer bei mittlerer Leistung ca. 2 Stunden, Lieferung inkl. 1 Gasdose

		Stück	1
430 39 00	H: 9.5 cm, 25 cm Ø, 2200 W, 2.9 kg	1	1 289.00 260.10 10 %



Transportabler Gaskocher

Mit automatischer Piezo-Zündung, Lieferung ohne Kartusche

Gerät ist nicht für den dauerhaften gewerblichen Einsatz geeignet.

		Stück	1
430 40 00	35.7 x 27.6 cm, H: 10.6 cm 2900 W, 1.6 kg	1	1 33.00
430 40 50	Ersatz-Kartuschen	4	1 3.40



Suppen-Rechaud CNS

Mobil und platzsparend, Platte 18 cm Ø

		Stück	1
430 42 00	24 x 24 cm, H: 7.5 cm, 230 V, 2000 W, 2.9 kg	1	1 139.00



Induktions-Réchaud

Extra dünnes Gehäuse (32 mm) mit Edelstahlrahmen, geeignet für Kochgeschirr von ø 120 mm bis maximal 260 mm, Touch-Control-Bedienfeld
Gerät ist nicht für den dauerhaften gewerblichen Einsatz geeignet

		Stück	1
430 42 20	29.6 x 37 cm, H: 4.6 cm, 230 V, 2000 W	1	1 159.00 143.10 10 %



Induktions-Kocher

Kochfläche Glas 24 cm Ø, Gehäuse Edelstahl, Touch-Control-Bedienfeld mit Digitalanzeige
Timer, 10 Leistungsstufen (500 - 3500 W), 10-stufige Temperatureinstellung, Temperaturbereich: 60 °C bis 240 °C, Elektronischer Überhitzungsschutz
Gerät ist nicht für den dauerhaften gewerblichen Einsatz geeignet

		Stück	1
432 48 24	34 x 44.5 cm, H: 11.7 cm, 230 V, 3.5 kW, 7.45 kg, Stecker Typ 23	1	1 325.00



Induktions-Kochstellen Spring

Professionelles Gerät für den flexiblen Einsatz am Buffet, im Garten oder für den Party-service. Aus CNS mit Ceran-Glasplatte, hohe Leistung, reduziert Kochzeit und Energieverbrauch, blitzschnell regulierbare Temperatur, einstellbare Warmhaltetemperatur, waschbarer Fettfilter

		Stück	1
430 46 25	42.5 x 33 cm, H: 11 cm, 230 V, 2.5 kW, 6.5 kg, Stecker Typ: 23, Kochfläche 20 cm Ø	1	1 999.00 899.10 10 %
430 46 35	52 x 38.5 cm, H: 17.5 cm, 230 V, 3.5 kW, 13 kg, Stecker Typ: 23, Kochfläche 27 cm Ø	1	1 1799.00 1619.10



Induktions-Kocher

Mit Leistungszuschaltung der vorderen Stelle bis zu 5000 W!
2 Platten - getrennt schaltbar, Kochfläche Glas, Gehäuse Edelstahl, Digitalanzeige auf dem Glasfeld, Leistungsregulierung über Knebelbedienung, elektronischer Überhitzungsschutz

- 10 Leistungsstufen: (800 - 3500 W / 800 - 3500 W)
- + 1 weitere Leistungsstufe: (800 - 5000 W / 800 - 2000 W)

		Stück	1
400 98 00	40.5 x 70 cm, H: 13.8 cm, 3NAC 400 V, 7 kW, 15 kg	1	1 1470.00

Eierkocher mit 6 Einsätzen

Eierkocher mit 6 separaten Einsätzen, so kann für jeden Gast die gewünschte Kochzeit gewählt werden, Edelstahlbehälter, der eingebaute Widerstand und Temperaturbegrenzer sorgen für einen sicheren Kochvorgang
Thermostatregler, Edelstahldeckel zum Verstauen



		Stück		1
432 04 00	43 x 21.5 cm, H: 25.5 cm, 230 V, 1200, 4.5 kg	1	1	704.00 563.20
				20 %

Toaster Quattro

Gehäuse aus Edelstahl, automatischer Toast-Lift, Brosamenschublade, Timer zum Einstellen des Bräunungsgrades, 3 LED-Kontrollleuchten



		Stück		1
430 67 00	28.5 x 32 cm, H: 20 cm, 230 V, 1600 W, 3 kg	1	1	99.00 79.20
				20 %

Durchlauftoaster

Edelstahl, mit regelbarer Bandgeschwindigkeit



		Stück		1
430 66 00	Mini, 75 Toastscheiben pro Stunde, 29 x 44 cm, H: 38.5 cm, 230 V, 1340 W, 14.5 kg	1	1	590.00
430 66 01	Maxi, 150 Toastscheiben pro Stunde, 36.8 x 44 cm, H: 38.5 cm, 230 V, 2240 W, 17.4 kg	1	1	785.00

Toaster für 4 Scheiben

Gehäuse aus Edelstahl, ideal für Buffets, Brosamenschublade, regelbare Bräunungsstufen, Bräunung wahlweise eine oder beidseitig



		Stück		1
431 17 00	37.5x32.8 cm, H: 23.4 cm, 1NAC 230 V, 2700 W, 4.2 kg, Steckertyp 23	1	1	690.00

Sandwich-/Toast-Automaten

Gehäuse CNS 18/8, mit Schublade für Brosamen, Zeitschaltuhr, eine Kontroll-Lampe pro Zange, Nutzfläche: 14 x 15/2.5cm



		Stück		1
430 50 02	2 Zangen, 13 x 31 cm, H: 27 cm, 230 V, 900 W, 6 kg	1	1	825.00
430 50 03	3 Zangen, 26 x 31 cm, H: 27 cm, 230 V, 1350 W, 8 kg	1	1	1225.00
430 50 04	4 Zangen, 31 x 31 cm, H: 27 cm, 230 V, 1800 W, 10 kg	1	1	1475.00

Toast/Überbackgerät

Für Spiegeleier, Sandwiches, Pizzas, Steaks, Käsekuchen, Toasts, Bratwürste, Hamburger. Zum Gratinieren, Auftauen etc. sehr kurze Aufheizzeit, Zeitschaltuhr 0 - 15 Minuten, mit Schublade für Brotkrumen



		Stück		1
430 56 01	1 Ebene, 47 x 23 cm, H: 22.5 cm, 230 V, 2000 W, 8.2 kg	1	1	248.00
430 57 01	2 Ebenen, 47 x 26 cm, H: 40 cm, 230 V, 3 kW, 9.7 kg, Stecker Typ: 23	1	1	312.00
430 56 50	Toastzange	1	1	19.00



Hot Dog-Apparat

Gehäuse CNS
 - Glaszylinder 195 mm Ø, H: 24 cm
 - Temperaturregler von 30 - 90° C
 - mit vier Spiessen

		Stück		
430 53 00	50 x 28 cm, H: 35 cm, 230 V, 1100 W, 9,6 kg	1	1	420.00
430 53 50	Ersatzglas	1	1	138.00



Back- und Grillier-Emulsion Thermosil

Vermindert das Haften von Back- und Grillgut auf Brat- und Grillflächen, Backblechen oder Backformen etc. Erleichtert die Reinigung, schützt und pflegt Material, Silikondichtungen etc.

		Stück		
430 95 50	Bidon 5 l	1	1	96.00



Grillier-Pinsel

Neusilberdraht 0.1mm, hitzebeständig und oxydationsfrei

		Stück		
430 90 00	22 x 4 cm	1	1	27.00



Grill-Pinsel / Bürsten

Stahldraht 0.2 mm

		Stück		
430 91 00	Grill-Reinigungspinsel, 23 x 4 cm	1	1	8.00
430 92 01	Grill-Spachtelbürste mit Schaber, 24.5 x 4 cm	1	1	12.00
430 92 02	Grill-Spachtelbürste mit Schaber, 26 x 4 cm	1	1	13.00
430 93 00	Grillbürste, 40 x 6 cm	1	1	25.00



Brandschutz-Decke EMPA geprüft

		Stück		
431 28 00	100 x 100 cm	1	1	30.00
431 28 10	125 x 180 cm	1	1	44.00



Grillplatte

Gehäuse aus Edelstahl, hartverchromte Grillplatte (9 mm stark) für einfache Reinigung, entnehmbare Fettschublade und extra hoher Spritzschutz, Temperatur stufenlos bis 300°C regelbar, Überhitzungsschutz, für den Dauereinsatz geeignet, An-/Aus-Schalter mit Kontrollleuchte, Anti-Rutschfüsse

Grillfläche 51.8 x 32.8 cm, glatte Ausführung

		Stück		
430 99 00	55 x 43 cm, H: 26 cm, 230 V, 2400 W, 24 kg	1	1	910.00 728.00 20 %



Elektro Griddle-Tischgerät

Griddleplatte glatt aus Stahl mit Grillfläche 32 x 48 cm, Thermostat für konstante Betriebstemperatur zwischen 50 °C - 300 °C, Aufheiz-Kontrollleuchte, thermostatisch geregelte Aussuschaltung, inklusive Reinigungsschaber

		Stück		
430 97 00	33.5 x 54 cm, H: 29.5 cm, 230 V, 3 kW, 22 kg, Stecker Typ: 23	1	1	430.00

Elektro Griddleplatte verchromt glatt

Griddleplatte verchromt mit Grillfläche 32 x 48 cm, Thermostat für konstante Betriebstemperatur zwischen 50 °C - 300 °C, Aufheiz-Kontrollleuchte, thermostatisch geregelte Ausssschaltung, inklusive Reinigungsschaber

432 45 00	Griddleplatte glatt, 32.5 x 54 cm, H: 29.5 cm, 230 V, 3 kW, 22 kg, Stecker Typ: 23	Stück		580.00
		1	1	



Elektro Griddleplatte verchromt gerillt

Griddleplatte verchromt mit Grillfläche 32 x 48 cm, Thermostat für konstante Betriebstemperatur zwischen 50 °C - 300 °C, Aufheiz-Kontrollleuchte, thermostatisch geregelte Ausssschaltung, inklusive Reinigungsschaber

432 45 10	Griddleplatte gerillt, 32.5 x 54 cm, H: 29.5 cm, 230 V, 3 kW, 22 kg, Stecker Typ: 23	Stück		720.00
		1	1	



720.-

Elektro Griddleplatte verchromt glatt

Griddleplatte verchromt mit Grillfläche 65 x 48 cm, Thermostat für konstante Betriebstemperatur zwischen 50 °C - 300 °C, Aufheiz-Kontrollleuchte, thermostatisch geregelte Ausssschaltung, inklusive Reinigungsschaber

432 46 00	Griddleplatte glatt, 66 x 54 cm, H: 29.5 cm, 3NAC 400 V, 6 kW, 41 kg	Stück		960.00
		1	1	



Elektro Griddleplatte verchromt gerillt/glatt

Griddleplatte verchromt mit Grillfläche 65 x 48 cm, Thermostat für konstante Betriebstemperatur zwischen 50 °C - 300 °C, Aufheiz-Kontrollleuchte, thermostatisch geregelte Ausssschaltung, inklusive Reinigungsschaber

432 46 10	Griddleplatte gerillt/glatt, 66 x 54 cm, H: 29.5 cm, 3NAC 400 V, 6 kW, 41 kg	Stück		1090.00
		1	1	



NEW

Elektro Kontaktgrill Panini

Grosse Grillfläche, Grillplatten gerillt, robustes Gerät aus CNS, Gusseisen-Grillplatten für optimale Wärmeübertragung, Thermostat regelbar von 50 - 300° C, Aufheizkontrollleuchte, Fettauffangschale
Grillplatte: 34 x 23 cm

430 83 00	43 x 37 cm, H: 21 cm, 230 V, 2.2 kW, 21 kg	Stück		367.50
		1	1	

~~525.00~~

30 %



Elektro Kontaktgrill

Grillplatten oben gerillt, unten glatt, robustes Gerät aus CNS, Grillplatten aus Gusseisen für optimale Wärmeübertragung, Thermostat regelbar von 50 - 300° C, Aufheizkontrollleuchte, Fettauffangschale
Grillfläche unten 47.5 x 23 cm

430 78 00	Doppel-Kontaktgrill, 2 getrennte Thermostate, 57 x 37 cm, H: 21 cm, 230 V, 3.6 kW, 29 kg, Stecker Typ: 23	Stück		549.50
		1	1	

~~785.00~~

30 %



1480.-



Salamander Typ 600

Gehäuse aus Edelstahl, Energieeinstellung und Kontrollleuchten, variable Höheneinstellung dank des geschmeidigen Hubsystems
Tropfschale mit Gitter von 59 x 32 cm ist ausfahrbar

		Stück		1
430 68 00	60 x 52 cm, H: 52.5 cm, 230 V, 3.6 kW	1	1	1850.00 1480.00 20 %



Bartscher Hi-Light Salamander GN 1/1

Bedienereblende aus unverwüstlichem Hartglas mit Touch-Screen-Bedienung

CNS 18/10, erhebliche Energieeinsparung von bis zu 65%! Weniger Abwärme, 3 Heizelemente, mit Warmhaltefunktionen, volle Heizleistung oder nur 1/3 für kleine Speisen, automatische Abschaltung, Memory-Funktion des Timers, 3 einstellbare Zeitprogramme, schnelle Aufheizzeit innert 5 Sekunden, höhenverstellbares Heizelement, Fettauffangschale und Grillrost B 53 x T 36.5 cm, inklusive Wandbefestigung
B 57 x T 53 x H 52 cm, 50 kg - Leistung 4.5 kW / 3 NAC / 400 V

		Stück		1
430 58 10	Tellererkennung: Nein	1	1	3490.00
430 58 15	Tellererkennung: Ja	1	1	3840.00



Mikrowellen-Gerät mit Grill Eco

Gehäuse und Garraum aus Edelstahl, Drehglasteller, 9 Leistungsstufen, manuelle Zeitschaltuhr, Auftaufunktion, Innenmass 33 x 32.5cm, H: 20.5 cm, Garraum 23 l
Mikrowellenleistung: 900 W
Grillleistung: 1000 W

		Stück		1
430 60 00	48.3 x 42.5 cm, H: 28.1 cm, 230 V, 1400 W, 13.5 kg	1	1	279.00



Mikrowellen-Gerät Sharp R-15 AM

Ganz aus CNS, Digitalanzeige, 3 Leistungsstufen, Wiederholbetrieb, automatisch gesteuertes Auftauen, Innenmass 37.2 x 35.1 cm, H: 21.1 cm, Garraum 28 l

		Stück		1
430 63 00	52 x 42.4 cm, H: 30.9 cm, 230 V, 1000 W, 18 kg	1	1	999.00

705.-



Mikrowellen-Gerät Expert

Gehäuse und Garraum aus Edelstahl, 3 Leistungsstufen, Digitalkontrolle, 10 Programmspeicher, doppelt belegbar, Innenmass 33.5 x 36 cm, H: 20 cm, Mikrowellenleistung: 1000 Watt/1 Magnetron, Garraum 25 l

		Stück		1
430 65 01	52 x 44 cm, H: 31 cm, 230 V, 1000 W, 17.6 kg	1	1	705.00



Mikrowellen-Gerät Magnus

Zwei Magnetrons sorgen für gleichmässige Ergebnisse
Gehäuse und Garraum aus Edelstahl, 5 Leistungsstufen, Digitale Einstellung mit 30 Programmspeichern und 2 Auftaufunktionen, Mikrowellenleistung: 1.85 kW, 2 Magnetrons, Innenmasse: 37 x 37 cm, H: 19 cm, Aussenmasse: 46.4 x 55.7 H: 36.8 cm, Fassungsvermögen 26 Liter, geeignet für 2/3 GN

		Stück		1
430 96 00	46.4 x 55.7 cm, H: 36.8 cm, 230 V, 3.2 kW, 32 kg, Stecker Typ: 23	1	1	1785.00

Küche

Caldo Lux Cook & Hold

Das professionelle Warmhaltegerät zum Top-Preis - ideal für Partyservice und Catering. Tragbar, stapelbar, überall einsatzbereit, digitale Bedieneinheit, Cook-Funktion, max. 120° C für Langzeitgaren (Garen über Nacht), Hold-Funktion zum gradgenauen Warmhalten, Kerntemperatursonde serienmässig, links-/ rechts-Türbandung, robuste Tür mit Magnetverschluss, Garraum mit abgerundeten Ecken



		Stück		1
431 49 00	Einschubabstand 67 mm, GN: 3 x 1/1, 43.6 x 64.5 cm, H: 40.9 cm, 230 V, 760 W, 25 kg	1	1	1720.00

Hold-o-mat Cook & Hold

Professionelles Warmhaltegerät, ideal für Partyservice und Catering. Präzise und kostengünstig, Genauigkeit der Temperatur +/- 1° C, dank optimaler Entfeuchtung auch für panierte Speisen und Backwaren geeignet, Garen über Nacht 4 x GN 1/1 65 cm, oder 2 x GN 1/1 100 cm, 1.5 kW, 230 V, 50 Hz



		Stück		1
431 50 01	GN: 3 x 1/1, 41.5 x 67.5 cm, H: 34.3 cm, 230 V, 1000 W, 24 kg	1	1	3560.00 3204.00 10 %
431 50 03	Kerntemperatursteuerung, GN: 3 x 1/1, 41.5 x 67.5 cm, H: 34.3 cm, 230 V, 1000 W, 24 kg	1	1	3990.00 3591.00
431 50 04	GN: 4 x 1/1, 41.5 x 67.5 cm, H: 42.3 cm, 230 V, 1500 W, 28 kg	1	1	3730.00 3357.00
431 50 50	Kerntemperatur-Sonde zu Hold-o-mat 411	1	1	360.00 324.00
431 50 02	GN: 7 x 1/1, 41.5 x 67.5 cm, H: 63.8 cm, 230 V, 1800 W, 38 kg	1	1	5760.00 5184.00

Heissluftofen Anna AS Unox 4 x 460/330

Mit elektromechanischer Steuerung
CNS 18/10, 4 Backbleche 460 x 330 mm inklusive, Doppeltürverglasung mit Hitzeschutz, CNS Backkammer, max. Temperatur 260°C, Abstand zwischen den Blechen: 75 mm



		Stück		1
432 49 00	60 x 58.7 cm, H: 47.2 cm, 230 V, 2000 W, 22 kg	1	1	895.00
431 93 50	Grillrost verchromt, 460x330mm	1	1	19.00

Kombidämpfer Unox ChefTop PLUS

Leistungstark, preiswert - inkl. den Vorzügen wie:

- Kürzere Aufheizzeiten durch höhere Leistung
- ADAPTIVE.Cooking-Funktion: Ständige Überwachung der relevanten Garparametern während des Garprozesses und automatische Anpassung der Programme zur Erreichung des perfekten Garergebnisses
- MULTI.Time-Funktion: Verschieden Lebensmittel mit unterschiedlichen Garzeiten zur selben Zeit garen
- MISE.EN.PLACE-Funktion: Verschiedene Gerichte zur selben Zeit fertig haben
- Vorgespeicherte Garprogramme CHEFUNOX



Kombidämpfer ChefTop PLUS, 5 x GN 1/1

Code	Specs	Box	Stück	Price
432 64 05	75 x 77.3 cm, H: 67.5 cm, 400 V, 9.3 kW, 70 kg	1	1	5870.00



Kombidämpfer ChefTop PLUS, 7 x GN 1/1

Code	Specs	Box	Stück	Price
432 64 07	75 x 77.3 cm, H: 84.3 cm, 400 V, 11.7 kW, 85 kg	1	1	7850.00

Kombidämpfer ChefTop PLUS, 10 x GN 1/1

Code	Specs	Box	Stück	Price
432 64 10	75 x 77.3 cm, H: 101 cm, 400 V, 18.5 kW, 95 kg	1	1	10590.00

Alle Modelle sind auch rechts gebandet erhältlich!

Wir beraten Sie gerne



Zubehör ChefTop GN 1/1

Code	Description	Box	Stück	Price
432 63 50	Untergestell ohne Auflageschienen, 73.2 x 54.6 cm, H: 69.2 cm	1	1	615.00
432 63 51	Einhängegestelle für Untergest., 7 x GN 1/1	1	1	154.00
432 60 60	Dampfabzugshaube mit Dampfkondensator	1	1	1990.00
432 60 64	Reinigungsmittel Rotor.KLEAN Serie 6 MIND.Maps	1	10	129.00
432 61 52	Entkalker UNOX.Pure	1	1	380.00
432 61 55	Ersatzkartuschen zu Entkalker UNOX Pure	1	1	290.00



Bleche und Roste GN 1/1

Code	Description	Box	Stück	Price
441 94 11	Einschubrost, GN: 1/1, 53 x 32.5 cm	1	1	35.00
432 60 56	Blech Aluminium, GN 1/1, 53 x 32.5 cm	1	1	52.00
432 60 57	FakiroGrill - Grillplatte Aluminium Teflonbeschichtet, GN 1/1, 53 x 32.5 cm	1	1	233.00
432 60 63	FakiroPizza - Aluminiumplatte für Pizza, GN 1/1, 53 x 32.5 cm	1	1	168.00
432 60 65	FakiroGrill - Grillplatte Teflonbeschichtet, GN 1/1, 53 x 32.5 cm	1	1	168.00



Entkalker / Steamer-Reiniger

Giftige Produkte - Unbedingt Vorsichtsmassnahmen beachten!

Code	Description	Box	Stück	Price
600 00 00	Entkalker, Calcex Liquid, 1.02 l	1	12 1 =	138.00 11.50
600 01 00	Steamer-Reiniger, Mudex, 1.02 l	1	6 1 =	104.00 17.33

Küche

MAXFRY®

Schneller, besser und gesünder frittieren? Die Lösung heisst: Maxfry Classic Nat

Das auf natürlicher Basis entwickelte Additiv, Maxfry Classic Nat, verlängert die Lebensdauer von Frittierfetten und Frittierölen um ein Vielfaches und steigert die Qualität der darin zubereiteten Speisen.

- Vielfach längere Standzeit des Fettes/Öles
- Seltener Öl- oder Fettwechsel
- Keine Harzbildung mehr am Frittierkorb
- Knusprigere, fettärmere Produkte
- Geringerer Energieverbrauch durch niedrigere Temperaturen
- Geringere Schadstoffbelastung durch niedrigere Temperaturen

Weitere Informationen finden Sie unter: maxfry.ch

Maxfry® Classic nat.

Starter-Set bestehend aus:
2l Maxfry® Classic nat. / 1 hulu Filter



		Stück		1
440 05 10	Set 2-teilig	1	1	274.00 246.60

Maxfry® Classic nat.

		Stück		1
440 04 20	2 l Maxfry Classic nat.	1	1	179.00
440 04 50	5 l Maxfry Classic nat.	1	1	379.00



Öl-Handfilter

Gestell CNS mit Filtersack

		Stück		1
440 25 00	Öl-Handfilter komplett, 57 x 23 cm	1	1	95.00
440 25 50	Ersatz-Filtersack, 35 x 23 cm	1	1	69.00



Fritier-Oeltester Testo 270

Mit Maxfry und Testo 270 immer auf der sicheren Seite - und dies in Sekundenschnelle! Testo 270 liefert die Qualität mit Polarenanteilen in Prozent und zugleich die Temperatur des Öles. So wissen Sie genau, in welchem Zustand sich Ihr Frittieröl oder -fett befindet und ob es ausgetauscht werden muss. Die Messung kann unkompliziert im laufenden Betrieb erfolgen.

Ergonomisches Design und robuste Verarbeitung, unter fliessendem Wasser abwaschbar (IP65), eindeutige Alarmierung nach dem Ampelprinzip über beleuchtetes Display, Hold- und Auto-Hold-Funktion, Kalibrierung und Justage selbst durchführbar

		Stück		1
440 23 00	Komplettes Set im Kunststoffkoffer	1	1	459.00



Tisch-Fritteusen Midi

Komplett aus CNS, mit Ablasshahn, abgerundetes Becken, stufenloser Temperaturregler, problemlose Reinigung dank herausnehmbaren Heizelementen Sicherheitsthermostat

		Stück		1
431 38 08	8 l, 29x55 cm, H: 41 cm, 230V, 1NAC, 3.25 kW, 16A, 10 kg, Stecker Typ: 23	1	1	370.00
431 39 16	2 x 8 l, 58 x 55 cm, H: 41 cm, 2 x 3.25 kW, 2 x 230V, 1NAC, 2 x 16A (2 Kabel), 22 kg, 2 x Stecker Typ: 23	1	1	625.00



Tisch-Fritteusen Professional

Komplett aus CNS, mit Ablasshahn, abgerundetes Becken, stufenloser Temperaturregler, problemlose Reinigung dank herausnehmbaren Heizelementen Sicherheitsthermostat

		Stück		1
432 72 10	10 l, 39 x 45 cm, H: 37.5 cm, 400V, 3NAC, 8.1 kW, 13 kg	1	1	675.00
432 72 20	2 x 10 l, 78 x 45 cm, H: 37.5 cm, 2 x 8.1 kW, 2 x 400V, 3NAC, 22 kg	1	1	1190.00





Pizzaofen Mini Plus 1

Einkammer-Pizzaofen aus Edelstahl, Boden aus hitzebeständigem Stein, Ober- und Unterhitze getrennt regelbar, mit Innenbeleuchtung, Temperatur bis 300°C

1 Backkammer: 41 x 37 cm, H: 9 cm (für 1 Pizza 35 cm Ø).
Auch zum Erwärmen von heissem Stein geeignet

431 25 00	57 x 47 cm, H: 25 cm, 230 V, 2 kW, 20 kg		Stück	1	610.00
			1	1	



Pizzaofen Mini Plus 2

Zweikammer-Pizzaofen aus Edelstahl, Boden aus hitzebeständigem Stein, Ober- und Unterhitze getrennt regelbar, mit Innenbeleuchtung, Temperatur bis 300°C

2 Backkammern à je 41 x 37 cm, H: 90 cm (für 2 x 1 Pizza 35 cm Ø)
Auch zum Erwärmen von heissem Stein geeignet

431 26 00	57 x 47 cm, H: 45 cm, 230 V, 3.4 kW, 35 kg		Stück	1	1090.00
			1	1	



Pizzaschieber

Aluminium mit schwarzem Alu-Griff

431 18 33	180 cm, 33 x 33 cm		Stück	1	127.00
			1	1	
431 18 36	183 cm, 36 x 36 cm		1	1	129.00



Ofenbürste

CNS 18/10 mit Naturborsten, schwere Qualität

431 19 17	180 cm		Stück	1	138.00
		1	1		



Pizzaschneider CNS

441 90 01	Glatt, 19 cm, 7 cm Ø		Stück	1	8.00
		1	1		



Stück ab
0,26

Pizza-Boxen

Hart-Wellpappe mit Dampföchern, rot bedruckt, mit Öffnungslasche

			Stück			
			1	8	15	
460 00 29	29 x 29 cm, H: 3 cm	1	200 1=	69.00 0.35	62.10 0.32	51.75 0.26
460 00 32	32 x 32 cm, H: 3 cm	1	150 1=	64.00 0.43	57.60 0.39	48.00 0.32
460 01 30	Calzone, 30 x 16 cm, H: 10 cm	1	150 1=	69.00 0.46	62.10 0.41	51.75 0.35
460 01 50	Familie, 50 x 50 cm, H: 5 cm	1	50 1=			69.00 1.38

Werbedruck auf Anfrage möglich.



Thermobox Pizza

Aus widerstandsfähigem Polypropylen, säure- und bruchstabil, isolierfähig -40 bis +120°C, hygienisch, geschmacks- und geruchsneutral, spülmaschinenfest, mit Multifunktions-Deckel zum Verschliessen oder Ausdampfen

Innenmass 35 x 35 cm, Aussenmass 41 x 41 cm

		Stück		1
460 60 10*	1	1	95.00	76.00
460 60 17*	1	1	98.00	78.40
460 60 26*	1	1	108.00	86.40
460 60 30*	1	1	129.00	103.20

Küche

Wärmestrahler

Zum Aufhängen

Für optimale Speisenwarmhaltung, Infrarot-Quarzstrahler mit warmem Licht und hoher Strahlungsintensität

		Stück		
431 00 00	Aluminium gebürstet, verstellbar von 76 bis 135 cm, ohne Glühbirne, 17 cm Ø, 230 V, 250 W	1	1	295.00
431 00 50	Glühbirne klar	1	1	35.00
431 00 51	Glühbirne rubinrot	1	1	35.00
432 07 00	Massiv kupfer, verstellbar von 100 bis 220 cm, mit Glühbirne, 18 cm Ø, 230 V, 250 W	1	1	465.00
431 02 00	Alu silberfarbig, verstellbar von 85 bis 170 cm, ohne Glühbirne, 14 cm Ø, 230 V, 250 W	1	1	290.00 275.50
431 02 50	Infrarotbirne	1	1	43.60



Infrarot Wärmebrücke GN1/1 aus Aluminium, 550W

Höhenverstellbar 55 - 70 cm

- belüftete Aluminiumreflektoren Ein/Ausschalter

- Maximale Temperatur: 70° C

- Kabellänge: 1.5 m

- Inklusive: 1 Behälter 1/1 GN, 65 mm tief, Edelstahl

		Stück		
431 04 00	51 x 34.5 cm, 1NAC 230 V, 550 W, 2.6 kg	1	1	162.00



Buffet Wärmelampe

Lampenschirm und flexibler Arm in verchromter Ausführung inkl. 250 Watt-Weisslichtstrahler

		Stück		
431 03 00	20 x 20 cm, H: 70 cm, 230 V, 250 W	1	1	550.00 522.50



Infrarot Wärmebrücken

Alu eloxiert, zum Hängen, Quarzröhre mit Heizspiralen, Hauptschalter Ein/Aus optional Füße zum Stellen

		Stück		
431 43 05	ohne Füße, 46 x 15 cm, 230 V, 350 W, 3 kg	1	1	460.00
431 43 06	ohne Füße, 61 x 15 cm, 230 V, 500 W, 3 kg	1	1	480.00
431 43 08	ohne Füße, 76 x 15 cm, 230 V, 660 W, 4 kg	1	1	510.00
431 43 09	ohne Füße, 92 x 15 cm, 230 V, 800 W, 5 kg	1	1	540.00
431 43 12	ohne Füße, 122 cm, 230 V, 1100 W, 5 kg	1	1	590.00
431 43 14	ohne Füße, 137 x 15 cm, 230 V, 1250 W, 6 kg	1	1	625.00
431 44 01	1 Paar Füße	1	2	110.00
431 44 02	Hygieneblende, 92.2 x 24 cm	1	1	295.00
431 44 03	Hygieneblende, 122 x 24 cm	1	1	365.00





ROTOR

Aufschnittmaschine Rotor Gradschnitt

Gehäuse aus Druckgussaluminium mit Spezialmesser und stufenloser Schnitteinstellung von 0 bis 14 mm, inkl. Schleifvorrichtung, Schlitten abnehmbar, robuste und hygienische Konstruktion, reinigungsfreundlich. Messer 27.5 cm Ø

			Stück		1
432 75 00	Basic, Gradschnitt, 62 x 47 cm, H: 42.5 cm, 230 V, 187 W, 23 kg	1	1	1650.00	1485.00



HOFFMANN

Aufschnittmaschinen Gastro Line

Die zahnradbetriebene Profi-Aufschnittmaschine für den vielseitigen Einsatz im Gastgewerbe. Die reinigungsfreundlichen Ganzmetall-Maschinen in Elementbauweise bieten ein optimales Preis-/Leistungsverhältnis, garantieren den sicheren Betrieb und eine lange Lebensdauer
Garantie 1 Jahr

			Stück		1
430 86 25	25cm Ø, Gradschnitt, 46 x 32 cm, 230 V, 300 W, 21 kg	1	1	2670.00	2403.00
430 86 30	30cm Ø, Gradschnitt, 46 x 32 cm, 230 V, 300 W, 22 kg	1	1	3170.00	2853.00



HOFFMANN

Aufschnittmaschinen Profiline

Der Schwerkraftschneider mit der bewährten geschlossenen Standfläche, ausgelegt für den gewerblich-industriellen Dauereinsatz in Metzgerei- und Gastronomiebetrieben. Müheloses Schneiden sämtlicher Charcuterie-Waren. Das Spezial-Hohlschliffmesser sowie der grossflächige, leicht laufende Schlitten eignen sich vortrefflich zum Schneiden von grossvolumigem und schwerem Schnittgut. Glatte Formgebung, überdachte Konstruktion und robuste Bauweise garantieren präzise Leistung, sichere Funktion, praktische Handhabung, einfachste Reinigung und jahrelangen wirtschaftlichen Einsatz
Garantie 1 Jahr



			Stück		1
432 30 27	27cm Ø, Gradschnitt, 46.5 x 37.5 cm, 230 V, 300 W, 26 kg	1	1	4350.00	3915.00
432 30 30	30cm Ø, Gradschnitt, 53 x 43 cm, 230 V, 500 W, 40 kg	1	1	5150.00	4635.00
432 30 33	33cm Ø, Gradschnitt, 53 x 43 cm, 230 V, 500 W, 45 kg	1	1	5650.00	5085.00
432 31 33	33cm Ø, Schrägschnitt, 85.5 x 44.5 cm, 230 V, 450 W, 45 kg	1	1	5650.00	5085.00



HOFFMANN

Brotschneide-Maschine

Robuste Ganzmetall-Maschine mit verminderter Drehzahl, speziell für das Schneiden von Ofenfrischem Brot, einfache Reinigung
Garantie 1 Jahr

			Stück		1
432 33 25	25cm Ø, Schrägschnitt, 46 x 32 cm, 230 V, 300 W, 21 kg	1	1	2690.00	2421.00

Küche

hulu Tisch-Bain-Marie

Elektro-Wasserbad GN 1/1, 2 x 1/2 oder 3 x 1/3, für GN-Schalen bis 150 mm, regulierbarer Thermostat und Kontrolllampe, mit Ablasshahn und patentierter Heizplatte für geringeren Stromverbrauch

		Stück		1
430 43 00	54 x 34 cm, H: 24 cm, 1000 W, 230 V	1	1	306.00 214.20



214.20

Speiseausgabewagen beheizbar

		Stück		1
431 94 02	2 x GN 1/1, 93.6 x 71.4 cm, H: 93.3 cm, 230 V, 1.4 kW, 35.5 kg	1	1	1990.00 1492.50
431 94 03	3 x GN 1/1, 127.6 x 71.4 cm, H: 93.3 cm, 230 V, 2.1 kW, 44 kg	1	1	2390.00 1792.50

BLANCO



Tellerspender Eco beheizbar

Der ECO-Tellerspender bringt viele Vorteile: Weniger Verbrauch bei gleicher Leistung, mehr Kapazität durch kluge Konstruktion und grössere Flexibilität für jede Grösse! Geräteinnenraum-Temperatur von +30°C bis +110 °C regelbar, herausnehmbarer Stapeleinsatz, 4 Lenkrollen, davon 2 mit Bremsen

		Stück		1
431 97 00	ca. 80 Teller 18-33 cm Ø 68 x 52 cm, H: 90 cm, 230 V, 900 W, 44 kg	1	1	2090.00 1567.50
431 97 01	ca. 160 Teller 18-33 cm Ø 107.6 x 52 cm, H: 90 cm, 230 V, 900 W, 69 kg	1	1	2690.00 2017.50

BLANCO



TOP

Tellerhauben aus Kunststoff

Auch für Mikrowellenöfen und Wärmewagen

		Stück		1
441 20 24	Für Teller Ø 24.7 - 25.3 cm	1	1	8.95
441 20 25	Für Teller Ø 25 - 25.7 cm	1	1	9.00
441 20 26	Für Teller Ø 25.8 - 26.5 cm	1	1	9.00
441 20 27	Für Teller Ø 26.4 - 27 cm	1	1	9.00
441 20 28	Für Teller Ø 27.6 - 28.3 cm	1	1	10.50
441 20 30	Für Teller Ø 29.4 - 30 cm	1	1	10.50
441 20 31	Für Teller Ø 31 cm	1	1	10.50
441 20 32	Für Teller Ø 31.2 - 32 cm	1	1	12.50



Room-Serve

Das Wärmeglockensystem garantiert eine herausragende Warmhalteleistung, insbesondere im Zimmerservice.

Der Artikel aus Unterteller und Glocke besteht aus 100% lebensmittelechtem, doppelwandigem Material mit isolierender Zwischenschicht. Beide Teile sind spülmaschinenfest und perfekt stapelbar. Die Oberfläche ist kratz- und stoßfest.

Aussenmasse: 32.5 cm Ø / H: 10 cm

Innenmasse: 29.5 Ø cm / H: 6 cm

Für Teller bis 29 cm Ø

		Stück		1
135 96 29	Wärmeglocken-Set	1	1	42.00 29.40



29.40

ab
4.40

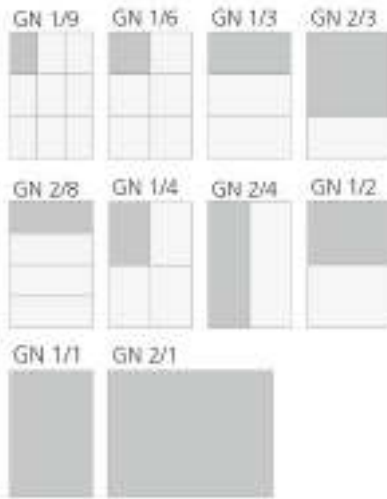

GN-Behälter Basic Polycarbonat

Schlag-, temperaturfest, -100 bis +100° C, mit Markierfeld für Inhalt und Datum

		Stück	1	10	20	
				10 %	20 %	
425 20 10	GN: 1/9, 176 x 108 mm, H: 100 mm	1	1	5.50	4.95	4.40
425 21 06	GN: 1/6, 176 x 162 mm, H: 65 mm	1	1	5.60	5.04	4.48
425 21 10	GN: 1/6, 176 x 162 mm, H: 100 mm	1	1	6.10	5.49	4.88
425 21 15	GN: 1/6, 176 x 162 mm, H: 150 mm	1	1	7.50	6.75	6.00
425 23 06	GN: 1/3, 325 x 176 mm, H: 65 mm	1	1	8.40	7.56	6.72
425 23 10	GN: 1/3, 325 x 176 mm, H: 100 mm	1	1	10.00	9.00	8.00
425 23 15	GN: 1/3, 325 x 176 mm, H: 150 mm	1	1	12.20	10.98	9.76
425 23 20	GN: 1/3, 325 x 176 mm, H: 200 mm	1	1	15.00	13.50	12.00
425 22 06	GN: 1/4, 265 x 162 mm, H: 65 mm	1	1	6.60	5.94	5.28
425 22 10	GN: 1/4, 265 x 162 mm, H: 100 mm	1	1	7.80	7.02	6.24
425 22 15	GN: 1/4, 265 x 162 mm, H: 150 mm	1	1	12.50	11.25	10.00
425 24 06	GN: 1/2, 325 x 265 mm, H: 65 mm	1	1	10.00	9.00	8.00
425 24 10	GN: 1/2, 325 x 265 mm, H: 100 mm	1	1	12.20	10.98	9.76
425 24 15	GN: 1/2, 325 x 265 mm, H: 150 mm	1	1	15.00	13.50	12.00
425 24 20	GN: 1/2, 325 x 265 mm, H: 200 mm	1	1	20.30	18.27	16.24
425 25 06	GN: 1/1, 530 x 325 mm, H: 65 mm	1	1	21.00	18.90	16.80
425 25 10	GN: 1/1, 530 x 325 mm, H: 100 mm	1	1	24.00	21.60	19.20
425 25 15	GN: 1/1, 530 x 325 mm, H: 150 mm	1	1	29.70	26.73	23.76
425 25 20	GN: 1/1, 530 x 325 mm, H: 200 mm	1	1	39.00	35.10	31.20

GN-Abtropfplatten Basic Polycarbonat



		Stück	1	10	20	
				10 %	20 %	
426 07 10	GN: 1/3	1	1	3.50	3.15	2.98
426 09 10	GN: 1/2	1	1	4.40	3.96	3.74
426 09 10	GN: 1/1	1	1	3.80	3.42	3.23

GN-Deckel Basic Polycarbonat



		Stück	1	10	20	
				10 %	20 %	
426 01 00	GN: 1/9	1	1	3.40	3.06	2.72
426 03 00	GN: 1/6	1	1	3.90	3.51	3.12
426 05 00	GN: 1/3	1	1	5.00	4.50	4.00
426 07 00	GN: 1/4	1	1	6.20	5.58	4.96
426 09 00	GN: 1/2	1	1	7.80	7.02	6.24
426 11 00	GN: 1/1	1	1	14.00	12.60	11.20

ab
9.61



GN Vorrats-/Transportbehälter mit Deckel

- Identity-Clip mit verschiedenen Farben für die optimale, hygienische Lagerung
- geeignet für Tiefkühler, Mikrowellen-Ofen
- Literkala mit Markierfeld für Inhalt und Datum
- Stapelbar
- 10 Jahre Garantie

		Stück	1	10	20	
				10 %	15 %	
420 70 10	GN: 1/9, 176 x 108 mm, H: 100 mm	1	1	11.30	10.17	9.61
420 71 10	GN: 1/6, 176 x 162 mm, H: 100 mm	1	1	13.00	11.70	11.05
420 72 15	GN: 1/4, 265 x 162 mm, H: 150 mm	1	1	15.40	13.86	13.09
420 73 15	GN: 1/3, 325 x 176 mm, H: 150 mm	1	1	18.90	17.01	16.07
420 74 10	GN: 1/2, 325 x 265 mm, H: 100 mm	1	1	24.70	22.23	21.00
420 74 15	GN: 1/2, 325 x 265 mm, H: 150 mm	1	1	28.30	25.47	24.06
420 75 15	GN: 2/3, 352 x 325 mm, H: 150 mm	1	1	34.30	30.87	29.16
420 76 06	GN: 1/1, 530 x 325 mm, H: 65 mm	1	1	37.70	33.93	32.05
420 76 10	GN: 1/1, 530 x 325 mm, H: 100 mm	1	1	41.30	37.17	35.11

Küche

GN-Behälter Blanco Polycarbonat

Schlag-, temperaturfest, -40 bis +100° C, mit Markierfeld für Inhalt und Datum

		Stück	1	10	20
421 00 10	GN: 1/9, 176 x 108 mm, H: 100 mm	1	1	8.50	7.65
				10 %	15 %
421 02 06	GN: 1/6, 176 x 162 mm, H: 65 mm	1	1	9.50	8.55
421 02 10	GN: 1/6, 176 x 162 mm, H: 100 mm	1	1	11.50	10.35
421 02 15	GN: 1/6, 176 x 162 mm, H: 150 mm	1	1	12.50	11.25
421 04 06	GN: 1/3, 325 x 176 mm, H: 65 mm	1	1	15.50	13.95
421 04 10	GN: 1/3, 325 x 176 mm, H: 100 mm	1	1	17.50	15.75
421 04 15	GN: 1/3, 325 x 176 mm, H: 150 mm	1	1	21.50	19.35
421 04 20	GN: 1/3, 325 x 176 mm, H: 200 mm	1	1	26.00	23.40
421 06 06	GN: 1/4, 265 x 162 mm, H: 65 mm	1	1	13.50	12.15
421 06 10	GN: 1/4, 265 x 162 mm, H: 100 mm	1	1	15.50	13.95
421 06 15	GN: 1/4, 265 x 162 mm, H: 150 mm	1	1	17.50	15.75
421 08 06	GN: 1/2, 325 x 265 mm, H: 65 mm	1	1	17.50	15.75
421 08 10	GN: 1/2, 325 x 265 mm, H: 100 mm	1	1	19.50	17.55
421 08 15	GN: 1/2, 325 x 265 mm, H: 150 mm	1	1	26.00	23.40
421 08 20	GN: 1/2, 325 x 265 mm, H: 200 mm	1	1	31.00	27.90
421 10 06	GN: 1/1, 530 x 325 mm, H: 65 mm	1	1	33.00	29.70
421 10 10	GN: 1/1, 530 x 325 mm, H: 100 mm	1	1	38.50	34.65
421 10 15	GN: 1/1, 530 x 325 mm, H: 150 mm	1	1	46.50	41.85
421 10 20	GN: 1/1, 530 x 325 mm, H: 200 mm	1	1	55.00	49.50



GN-Abtropfplatten Blanco Polycarbonat

		Stück	1	10	20
421 09 10	GN: 1/2	1	1	13.50	12.15
421 11 10	GN: 1/1	1	1	27.00	24.30



GN-Deckel Blanco Polycarbonat

		Stück	1	10	20
421 01 00	GN: 1/9	1	1	6.00	5.40
421 03 00	GN: 1/6	1	1	6.00	5.40
421 05 00	GN: 1/3	1	1	9.50	8.55
421 07 00	GN: 1/4	1	1	7.50	6.75
421 09 00	GN: 1/2	1	1	15.50	13.95
421 11 00	GN: 1/1	1	1	26.00	23.40



GN-Deckel Blanco Polycarbonat

Mit Löffel-Aussparung

		Stück	1	10	20
421 03 01	GN: 1/6, Löffel-Aussparung	1	1	8.50	7.65
421 05 01	GN: 1/3, Löffel-Aussparung	1	1	13.50	12.15
421 07 01	GN: 1/4, Löffel-Aussparung	1	1	9.50	8.55
421 09 01	GN: 1/2, Löffel-Aussparung	1	1	16.50	14.85
421 11 01	GN: 1/1, Löffel-Aussparung	1	1	28.00	25.20



Condibox-Saucen-, Garnituren- und Gemüsebox

Ihre Garnituren und Gewürze bleiben dank den 2 Kühlelementen während mehreren Stunden kühlfrisch. Box CNS 18/10 inkl. Deckel und Griffe, 5 Behälter GN 1/9 à 1 l und inkl. 2 Kühlakku GN 1/4.

		Stück	1	10	20
421 65 00	585 x 200 mm, H: 140 mm	1	1	741.00	666.90
421 65 50	Zusätzliche Kühlakku GN 1/4	1	1		35.00





GN-Behälter Basic

GN-Behälter nach EN 631

Alle Behälter sind aus rostfreiem Chrom-Nickel-Edelstahl mit elektrolytisch polierter (seiden-matter) Oberfläche und somit perfekt geeignet für professionellen Einsatz.



1/9 GN-Behälter Basic CNS 18/8

		Stück	1	10	20
				10 %	20 %
425 00 06	GN: 1/9, 176 x 108 mm, H: 65 mm	1	5.50	4.95	4.40
425 00 10	GN: 1/9, 176 x 108 mm, H: 100 mm	1	8.80	7.92	7.04
425 00 15	GN: 1/9, 176 x 108 mm, H: 150 mm	1	14.00	12.60	11.20



1/6 GN-Behälter Basic CNS 18/8

		Stück	1	10	20
				10 %	20 %
425 02 06	GN: 1/6, 176 x 162 mm, H: 65 mm	1	9.40	8.46	7.52
425 02 10	GN: 1/6, 176 x 162 mm, H: 100 mm	1	12.00	10.80	9.60
425 02 15	GN: 1/6, 176 x 162 mm, H: 150 mm	1	18.00	16.20	14.40
425 02 20	GN: 1/6, 176 x 162 mm, H: 200 mm	1	24.00	21.60	19.20

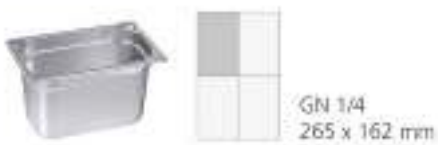

1/4 GN-Behälter Basic CNS 18/8

		Stück	1	10	20
				10 %	20 %
425 06 06	GN: 1/4, 265 x 162 mm, H: 65 mm	1	12.00	10.80	9.60
425 06 10	GN: 1/4, 265 x 162 mm, H: 100 mm	1	16.00	14.40	12.80
425 06 15	GN: 1/4, 265 x 162 mm, H: 150 mm	1	24.00	21.60	19.20
425 06 20	GN: 1/4, 265 x 162 mm, H: 200 mm	1	30.00	27.00	24.00



2/4 GN-Behälter Basic CNS 18/8

		Stück	1	10	20
				10 %	20 %
425 15 06	GN: 2/4, 530 x 162 mm, H: 65 mm	1	28.00	21.60	19.20
425 15 10	GN: 2/4, 530 x 162 mm, H: 100 mm	1	35.00	31.50	28.00
425 15 15	GN: 2/4, 530 x 162 mm, H: 150 mm	1	40.00	36.00	32.00



1/3 GN-Behälter Basic CNS 18/8

		Stück	1	10	20
				10 %	20 %
425 04 06	GN: 1/3, 325 x 176 mm, H: 65 mm	1	12.00	10.80	9.60
425 04 10	GN: 1/3, 325 x 176 mm, H: 100 mm	1	17.00	15.30	13.60
425 04 15	GN: 1/3, 325 x 176 mm, H: 150 mm	1	23.00	20.70	18.40
425 04 20	GN: 1/3, 325 x 176 mm, H: 200 mm	1	30.00	27.00	24.00

Küche

2/3 GN-Behälter Basic CNS 18/8

		Stück	1	10	20	
				10 %	20 %	
425 12 06	GN: 2/3, 354 x 325 mm, H: 65 mm	1	1	31.00	27.90	24.80
425 12 10	GN: 2/3, 354 x 325 mm, H: 100 mm	1	1	41.00	36.90	32.80
425 12 15	GN: 2/3, 354 x 325 mm, H: 150 mm	1	1	60.00	54.00	48.00
425 12 20	GN: 2/3, 354 x 325 mm, H: 200 mm	1	1	64.00	57.60	51.20



1/2 GN-Behälter Basic CNS 18/8

		Stück	1	10	20	
				10 %	20 %	
425 08 01	GN: 1/2, 325 x 265 mm, H: 20 mm	1	1	9.40	8.46	7.52
425 08 06	GN: 1/2, 325 x 265 mm, H: 65 mm	1	1	16.00	14.40	12.80
425 08 10	GN: 1/2, 325 x 265 mm, H: 100 mm	1	1	21.00	18.90	16.80
425 08 15	GN: 1/2, 325 x 265 mm, H: 150 mm	1	1	32.00	28.80	25.60
425 08 20	GN: 1/2, 325 x 265 mm, H: 200 mm	1	1	37.00	33.30	29.60



1/1 GN-Behälter Basic CNS 18/8

		Stück	1	10	20	
				10 %	20 %	
425 10 02	GN: 1/1, 530 x 325 mm, H: 20 mm	1	1	22.00	19.80	17.60
425 10 06	GN: 1/1, 530 x 325 mm, H: 65 mm	1	1	28.00	25.20	22.40
425 10 10	GN: 1/1, 530 x 325 mm, H: 100 mm	1	1	35.00	31.50	28.00
425 10 15	GN: 1/1, 530 x 325 mm, H: 150 mm	1	1	52.00	46.80	41.60
425 10 20	GN: 1/1, 530 x 325 mm, H: 200 mm	1	1	58.00	52.20	46.40



ab
17.60

1/1 GN-Behälter gelocht Basic 18/8

		Stück	1	10	20	
				10 %	20 %	
425 16 04	GN: 1/1, gelocht, 530 x 325 mm, H: 40 mm	1	1	32.00	28.80	25.60
425 16 06	GN: 1/1, gelocht, 530 x 325 mm, H: 65 mm	1	1	35.00	31.50	28.00
425 16 10	GN: 1/1, gelocht, 530 x 325 mm, H: 100 mm	1	1	40.00	36.00	32.00



Deckel GN-Behälter Basic CNS 18/8

		Stück	1	10	20	
				10 %	20 %	
425 01 00	GN: 1/9	1	1	6.90	6.21	5.52
425 03 00	GN: 1/6	1	1	8.40	7.56	6.72
425 07 00	GN: 1/4	1	1	9.50	8.55	7.60
425 06 00	GN: 2/4	1	1	14.00	12.60	11.20
425 05 00	GN: 1/3	1	1	12.00	10.80	9.60
425 13 00	GN: 2/3	1	1	22.00	19.80	17.60
425 09 00	GN: 1/2	1	1	14.00	12.60	11.20
425 11 00	GN: 1/1	1	1	23.00	20.70	18.40



Einschubblech GN Basic CNS 18/10

		Stück	1	10	20	
				10 %	20 %	
425 08 01	GN: 1/2, H: 20 mm	1	1	9.40	8.46	7.52
425 10 02	GN: 1/1, H: 20 mm	1	1	22.00	19.80	17.60
425 11 02	GN: 2/1, H: 20 mm	1	1	47.00	42.30	37.60



GN-Behälter Email

Die Email-Beschichtung verfügt über eine sehr gute Antihaft-Eigenschaft.

		Stück	1	10	20
422 15 02	GN: 1/1, 530 x 325 mm, H: 20 mm	1	1		29.00
422 15 04	GN: 1/1, 530 x 325 mm, H: 40 mm	1	1		31.00
422 15 06	GN: 1/1, 530 x 325 mm, H: 65 mm	1	1		33.00



GN-Behälter Blanco

Robust, stabil und perfekt für jahrelangen Einsatz im harten Küchen-Alltag: GN-Behälter und Deckel aus Edelstahl von BLANCO. Aus Chromnickelstahl 18/10 und in herausragender Verarbeitungs- und Material-Qualität – „Made in Germany“.

1/9 GN-Behälter Blanco CNS 18/10



		Stück	1	10	20
421 75 06	GN: 1/9, 176 x 108 mm, H: 65 mm	1	23.00	20.70 10 %	19.55 15 %
421 75 10	GN: 1/9, 176 x 108 mm, H: 100 mm	1	29.00	26.10	24.65

1/6 GN-Behälter Blanco CNS 18/10



		Stück	1	10	20
421 77 06	GN: 1/6, 176 x 162 mm, H: 65 mm	1	25.00	22.50 10 %	21.25 15 %
421 77 10	GN: 1/6, 176 x 162 mm, H: 100 mm	1	28.00	25.20	23.80
421 77 15	GN: 1/6, 176 x 162 mm, H: 150 mm	1	39.50	35.55	33.58
421 77 20	GN: 1/6, 176 x 162 mm, H: 200 mm	1	53.00	47.70	45.05

1/4 GN-Behälter Blanco CNS 18/10

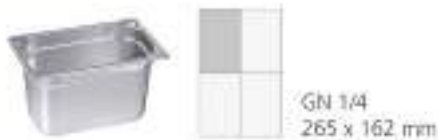

		Stück	1	10	20
421 83 06	GN: 1/4, 265 x 162 mm, H: 65 mm	1	28.00	25.20 10 %	23.80 15 %
421 83 10	GN: 1/4, 265 x 162 mm, H: 100 mm	1	33.00	29.70	28.05
421 83 15	GN: 1/4, 265 x 162 mm, H: 150 mm	1	46.50	41.85	39.53
421 83 20	GN: 1/4, 265 x 162 mm, H: 200 mm	1	60.00	54.00	51.00

2/4 GN-Behälter Blanco CNS 18/10



		Stück	1	10	20
421 85 06	GN: 2/4, 530 x 162 mm, H: 65 mm	1	56.00	50.40 10 %	47.60 15 %
421 85 10	GN: 2/4, 530 x 162 mm, H: 100 mm	1	74.50	67.05	63.33

1/3 GN-Behälter Blanco CNS 18/10



		Stück	1	10	20
421 79 06	GN: 1/3, 325 x 176 mm, H: 65 mm	1	28.00	25.20 10 %	23.80 15 %
421 79 10	GN: 1/3, 325 x 176 mm, H: 100 mm	1	37.00	33.30	31.45
421 79 15	GN: 1/3, 325 x 176 mm, H: 150 mm	1	51.50	46.35	43.78
421 79 20	GN: 1/3, 325 x 176 mm, H: 200 mm	1	65.00	58.50	55.25

2/3 GN-Behälter Blanco CNS 18/10



		Stück	1	10	20
421 81 06	GN: 2/3, 354 x 325 mm, H: 65 mm	1	39.50	35.55 10 %	33.58 15 %
421 81 10	GN: 2/3, 354 x 325 mm, H: 100 mm	1	50.50	45.45	42.93
421 81 15	GN: 2/3, 354 x 325 mm, H: 150 mm	1	69.50	62.55	59.08
421 81 20	GN: 2/3, 354 x 325 mm, H: 200 mm	1	94.00	84.60	79.90

1/2 GN-Behälter Blanco CNS 18/10



		Stück	1	10	20
421 86 04	GN: 1/2, 325 x 265 mm, H: 40 mm	1	28.00	25.20 10 %	23.80 15 %
421 86 06	GN: 1/2, 325 x 265 mm, H: 65 mm	1	31.00	27.90	26.35
421 86 10	GN: 1/2, 325 x 265 mm, H: 100 mm	1	34.00	30.60	28.90
421 86 15	GN: 1/2, 325 x 265 mm, H: 150 mm	1	50.50	45.45	42.93
421 86 20	GN: 1/2, 325 x 265 mm, H: 200 mm	1	67.50	60.75	57.38

Küche

1/1 GN-Behälter Blanco CNS 18/10

		Stück	1	10	20
				10 %	15 %
421 88 04	GN: 1/1, 530 x 325 mm, H: 40 mm	1	39.50	35.55	33.58
421 88 06	GN: 1/1, 530 x 325 mm, H: 65 mm	1	44.50	40.05	37.83
421 88 10	GN: 1/1, 530 x 325 mm, H: 100 mm	1	53.00	47.70	45.05
421 88 15	GN: 1/1, 530 x 325 mm, H: 150 mm	1	77.50	69.75	65.88
421 88 20	GN: 1/1, 530 x 325 mm, H: 200 mm	1	98.00	88.20	83.30



2/1 GN-Behälter Blanco CNS 18/10

		Stück	1	10	20
				10 %	15 %
421 91 04	GN: 2/1, 650 x 530 mm, H: 40 mm	1	73.50	66.15	62.48
421 91 06	GN: 2/1, 650 x 530 mm, H: 65 mm	1	92.00	82.80	78.20
421 91 10	GN: 2/1, 650 x 530 mm, H: 100 mm	1	106.00	95.40	90.10
421 91 15	GN: 2/1, 650 x 530 mm, H: 150 mm	1	155.00	139.50	131.75
421 91 20	GN: 2/1, 650 x 530 mm, H: 200 mm	1	189.00	170.10	160.65



GN-Behälter gelocht Blanco CNS 18/10

		Stück	1	10	20
				10 %	15 %
421 89 06	GN: 1/1, gelocht, 530 x 325 mm, H: 60 mm	1	71.50	64.35	60.78
421 89 10	GN: 1/1, gelocht, 530 x 325 mm, H: 95 mm	1	87.00	78.30	73.95



Deckel zu GN-Behälter Blanco CNS 18/10

		Stück	1	10	20
				10 %	15 %
421 76 00	GN: 1/9	1	16.50	14.85	14.03
421 78 00	GN: 1/6	1	19.50	17.55	16.58
421 80 00	GN: 1/3	1	16.50	14.85	14.03
421 82 00	GN: 2/3	1	33.00	29.70	28.05
421 84 00	GN: 1/4	1	21.50	19.35	18.28
421 87 00	GN: 1/2	1	26.00	23.40	22.10
421 90 00	GN: 1/1	1	36.50	32.85	31.03



GN-Zwischensteg mit Feder Blanco CNS

		Stück	1	20
420 60 32	325 mm	1	1	17.50
420 60 53	530 mm	1	1	19.50



GN-Einschublech Blanco CNS 18/10

mit glattem Rand, verstärkte Ausführung

		Stück	1	10	20
				10 %	15 %
421 94 02	GN: 1/1, H: 20 mm	1	37.50	33.75	31.88
421 95 02	GN: 2/1, H: 20 mm	1	72.50	65.25	61.63



GN Rost CNS 18/10

Rost ohne Füße

		Stück	1	20
441 94 11	Einschubrost, GN: 1/1, 53 x 32.5 cm	1	1	35.00
441 94 21	Einschubrost, GN: 2/1, 65 x 53 cm	1	1	52.90



Backblech GN 1/1

Silikon beschichtet

Gelocht Ø 3 mm, Materialstärke 1,5 mm, temperaturbeständig bis 240°C

		Stück	1	10	20
				10 %	20 %
425 14 11	GN: 1/1	1	43.00	38.70	34.40



GN-Behälter Vollrath CNS 18/10



		Stück	1	10	20	
				10 %	15 %	
420 20 06	GN: 1/9, 176 x 108 mm, H: 65 mm	1	1	16.60	14.94	14.11
420 20 10	GN: 1/9, 176 x 108 mm, H: 100 mm	1	1	21.50	19.35	18.28
420 22 06	GN: 1/6, 176 x 162 mm, H: 65 mm	1	1	17.70	15.93	15.05
420 22 10	GN: 1/6, 176 x 162 mm, H: 100 mm	1	1	19.60	17.64	16.66
420 22 15	GN: 1/6, 176 x 162 mm, H: 150 mm	1	1	24.50	22.05	20.83
420 22 20	GN: 1/6, 176 x 162 mm, H: 200 mm	1	1	44.10	39.69	37.49
420 24 06	GN: 1/3, 325 x 176 mm, H: 65 mm	1	1	21.50	19.35	18.28
420 24 10	GN: 1/3, 325 x 176 mm, H: 100 mm	1	1	26.40	23.76	22.44
420 24 15	GN: 1/3, 325 x 176 mm, H: 150 mm	1	1	35.20	31.68	29.92
420 24 20	GN: 1/3, 325 x 176 mm, H: 200 mm	1	1	39.20	35.28	33.32
420 26 06	GN: 2/3, 354 x 325 mm, H: 65 mm	1	1	33.30	29.97	28.31
420 26 10	GN: 2/3, 354 x 325 mm, H: 100 mm	1	1	39.90	35.91	33.92
420 26 15	GN: 2/3, 354 x 325 mm, H: 150 mm	1	1	49.00	44.10	41.65
420 26 20	GN: 2/3, 354 x 325 mm, H: 200 mm	1	1	56.80	51.12	48.28
420 28 06	GN: 1/4, 265 x 162 mm, H: 65 mm	1	1	19.60	17.64	16.66
420 28 10	GN: 1/4, 265 x 162 mm, H: 100 mm	1	1	23.50	21.15	19.98
420 28 15	GN: 1/4, 265 x 162 mm, H: 150 mm	1	1	27.40	24.66	23.29
420 28 20	GN: 1/4, 265 x 162 mm, H: 200 mm	1	1	36.20	32.58	30.77
420 38 06	GN: 2/4, 530 x 162 mm, H: 65 mm	1	1	31.30	28.17	26.61
420 38 10	GN: 2/4, 530 x 162 mm, H: 100 mm	1	1	39.20	35.28	33.32
420 30 04	GN: 1/2, 325 x 265 mm, H: 40 mm	1	1	19.60	17.64	16.66
420 30 06	GN: 1/2, 325 x 265 mm, H: 65 mm	1	1	27.40	24.66	23.29
420 30 10	GN: 1/2, 325 x 265 mm, H: 100 mm	1	1	29.40	26.46	24.99
420 30 15	GN: 1/2, 325 x 265 mm, H: 150 mm	1	1	41.10	36.99	34.94
420 30 20	GN: 1/2, 325 x 265 mm, H: 200 mm	1	1	46.00	41.40	39.10
420 32 04	GN: 1/1, 530 x 325 mm, H: 40 mm	1	1	35.20	31.68	29.92
420 32 06	GN: 1/1, 530 x 325 mm, H: 65 mm	1	1	43.10	38.79	36.64
420 32 10	GN: 1/1, 530 x 325 mm, H: 100 mm	1	1	48.00	43.20	40.80
420 32 15	GN: 1/1, 530 x 325 mm, H: 150 mm	1	1	66.60	59.94	56.61
420 32 20	GN: 1/1, 530 x 325 mm, H: 200 mm	1	1	76.40	68.76	64.94
420 36 04	GN: 2/1, 650 x 530 mm, H: 40 mm	1	1	68.60	61.74	58.31
420 36 06	GN: 2/1, 650 x 530 mm, H: 65 mm	1	1	78.40	70.56	66.64
420 36 10	GN: 2/1, 650 x 530 mm, H: 100 mm	1	1	117.00	105.30	99.45
420 36 15	GN: 2/1, 650 x 530 mm, H: 150 mm	1	1	156.00	140.40	132.60
420 36 20	GN: 2/1, 650 x 530 mm, H: 200 mm	1	1	176.00	158.40	149.60

GN-Behälter gelocht Vollrath CNS 18/10



		Stück	1	10	20	
				10 %	15 %	
420 27 06	GN: 2/3, gelocht, 354 x 325 mm, H: 65 mm	1	1	42.10	37.89	35.79
420 34 05	GN: 1/1, gelocht, 530 x 325 mm, H: 65 mm	1	1	46.90	42.21	39.87
420 34 10	GN: 1/1, gelocht, 530 x 325 mm, H: 100 mm	1	1	72.50	65.25	61.63

Deckel zu GN-Behälter CNS, Vollrath



		Stück	1	10	20	
				10 %	15 %	
420 21 00	GN: 1/9	1	1	9.20	8.28	7.82
420 23 00	GN: 1/6	1	1	9.80	8.82	8.33
420 25 00	GN: 1/3	1	1	14.70	13.23	12.50
420 27 00	GN: 2/3	1	1	21.50	19.35	18.28
420 29 00	GN: 1/4	1	1	12.70	11.43	10.80
420 31 00	GN: 1/2	1	1	18.60	16.74	15.81
420 33 00	GN: 1/1	1	1	28.40	25.56	24.14

GN-Einschubblech Vollrath CNS 18/10



		Stück	1	10	20	
				10 %	15 %	
420 32 02	GN: 1/1, H: 20 mm	1	1	27.90	25.11	23.72
420 36 02	GN: 2/1, H: 20 mm	1	1	63.70	57.33	54.15

Küche

Präzisions-Taschenwaage 0.1g/500g

Kleine Präzisionswaage für den mobilen Einsatz in der Molekularküche zum Wägen, Trieren, Zählen, mit Displayhinterleuchtung, Batteriebetrieb, Schutzdeckel und Hülle
Abmessung: 67 x 98 x 20 mm



Code	Teilung	Wägeplatte	Stück	Preis	Reduzierter Preis
432 28 00	0.1g/500g,	60 x 60	1	79.00	

Küchenwaage Eco

Kunststoff-Gehäuse. Abmessungen: 280 x 300 x 110 mm, Gewicht 3.2 kg, geeignet für nicht eichpflichtige Wägungen, inklusive Akku und Netzteil



Code	Teilung	Wägeplatte	Stück	Preis	Reduzierter Preis
430 31 15	5g/15kg,	CNS: 280 x 195 mm	1	390.00	195.00 (50 %)
430 31 16	1g/15kg,	CNS: 280 x 195 mm	1	490.00	294.00 (40 %)

Küchenwaage Gastronom CNS

Profiwaage aus CNS zum Wägen und Trieren, mit hinterleuchtetem LCD-Display, Netz- oder Akkubetrieb, Betriebsdauer mit Akku ca. 200 Std.



Code	Teilung	Wägeplatte	Stück	Preis	Reduzierter Preis
431 27 06	1 g/6 kg,	CNS: 233 x 192 mm	1	505.00	454.50 (10 %)
431 27 15	2 g/15 kg,	CNS: 233 x 192 mm	1	505.00	454.50

Küchen-/Bäckerwaage GEEICHT

Für eichpflichtige Wägungen, mit Tara, hinterleuchtetem LCD-Display, Netz- oder Akkubetrieb, Betriebsdauer mit Akku ca. 100 Std., Abmessung: 300 x 330 x 120 mm



Code	Teilung	Wägeplatte	Stück	Preis
432 27 01	Geeicht, 5g/30kg,	CNS: 300 x 240 mm	1	740.00
432 27 02	Ohne Eichung, 2g/30kg,	CNS: 300 x 240 mm	1	690.00
432 27 03	Ohne Eichung, 1g/30kg,	CNS: 300 x 240 mm	1	740.00

Markt-/Ladenwaage GEEICHT

Ämtlich geprüft und geeicht, mit Netzanschluss (Optional mit Akkubetrieb), hinterleuchteter LCD-Anzeige, Überlastungsschutz, Preisrechnung und 4 Preisspeicher (PLU), Kundenanzeige, programmierbar
Abmessungen: 280 x 320 x 122 mm



Code	Teilung	Wägeplatte	Stück	Preis
431 27 07	SP-3/6/G CH, 1g/0-3kg, 2g/3-6kg,	CNS: 260 x 200 mm	1	490.00

Universalwaage

Universalwaage zum Wägen, Trieren, Zählen, Anzeige mit 1.6 m Kabel für Wand- oder Tischmontage, hinterleuchtetem LCD-Display, Netz- oder Batteriebetrieb, Betriebsdauer Batterien ca. 30 Std.
Abmessung: 400 x 350 x 55 mm



Code	Teilung	Wägeplatte	Stück	Preis	Reduzierter Preis
432 26 06	20g/60kg,	CNS: 400 x 350 mm	1	440.00	264.00 (40 %)

Vakuum-Verpackungsmaschinen Multivac

Gehäuse und Kammer aus hochwertigem Edelstahl, Kammerdeckel aus Acrylglas, mit 2 Kunststoffeinlegplatten zur Anpassung der Siegelhöhe, Schrägeinsatz CNS zum Verpacken von Flüssigkeiten, Doppelnahttrennsiegelung, steckbarer Siegelschiene für die einfache Reinigung, hintergrundbeleuchtetes LCD-Display, 3 Speicherplätze für Anwenderprogramme, Schnellstoptaste.

- XXL-Garantie, welche folgende Leistungen beinhaltet: 2 zusätzliche Jahre Garantie, Total 3 Jahre ab Lieferdatum
- 2 kostenlose Wartungen vor Ort innerhalb der Garantiezeit inklusive
- Arbeitskosten, Reisekosten und Ersatzteilkosten inklusive
- Pikettzuschläge für Samstag, Sonntag und Freitag sind nicht eingerechnet

MULTIVAC



Vakuum-Verpackungsmaschine Multivac

Kammer 29 x 20.5 x 9 cm
Doppelnahttrennsiegelung, Schweisslänge 20.5 cm, Pumpe 4 m³/h

Max. Vakuum-Beutelgröße bis 20 x 25 cm

		Stück		1
432 99 10	38 x 38.5 cm, H: 27.5 cm, 230 V, 150 W, 27 kg	1	1	2290.00 2061.00

MULTIVAC



Vakuum-Verpackungsmaschine Multivac

Kammer 30.5 x 30 x 11 cm
Doppelnahttrennsiegelung, Schweisslänge 30.5 cm, Pumpe 8 m³/h

Max. Vakuum-Beutelgröße bis 30 x 35 cm

		Stück		1
432 99 20	38 x 51 cm, H: 31.5 cm, 230 V, 300 W, 36 kg	1	1	2990.00 2691.00



Vakuum-Verpackungsmaschine ERME T1

Max. Vakuum-Beutelgröße 25 x 40 cm, bis maximal ca. 3 kg Packgut, Doppel-/Trennschweißung, Dampferkennung, Vakuum-Stop

		Stück		1
432 06 24	30 x 51 cm, H: 24 cm, 450 W, 230 V, 31 kg	1	1	2990.00
432 06 25	Unterbau fahrbar mit 2 Schubladen, H: 61 cm	1	1	690.00



Vakuum-Verpackungsmaschine ERME Professional T3P

Max. Vakuum-Beutelgröße 31.5 x 45 cm, bis ca. 4 kg Packgut, Doppel-/Trennschweißung, automatische Dampferkennung, Mikroprozesssteuerung, Softbelüftung, kompatibel für GreenVAC

		Stück		1
432 06 36	37 x 60 cm, H: 36 cm, 1200 W, 230 V, 54 kg	1	1	4290.00
432 06 37	Unterbau fahrbar mit 3 Schubladen, H: 62 cm	1	1	790.00



Vakuum-Verpackungsmaschine ERME Professional T5P

Max. Vakuum-Beutelgröße 38 x 50 cm, bis ca. 5 kg Packgut, Doppel-/Trennschweißung, automatische Dampferkennung, Mikroprozesssteuerung, Softbelüftung, kompatibel für GreenVAC

		Stück		1
432 06 38	43 x 60 cm, H: 38 cm, 1200 W, 230 V, 63 kg	1	1	4690.00
432 06 39	Unterbau fahrbar mit 3 Schubladen, H: 62 cm	1	1	890.00

Küche

Green Vac GN-Behälter

Der vakuumierbare High-Tech GN-Behälter, GN Behälter mit Deckel, Dichtung, Ventil HACCP perfekt im Griff, Amortisation der Kosten in ca. 8 - 18 Monaten, cook & chill professionell organisierbar. Lagerung von vorbereiteten Lebensmitteln doppelt so lang wie ohne Vakuum. Auch druckempfindliche Produkte wie Beeren, Salat etc. sind vakuumierbar



		Stück		1
421 70 15	GN: 1/6, H: 15 cm	1	1	121.00
421 71 15	GN: 1/3, H: 15 cm	1	1	191.00
421 72 15	GN: 1/2, H: 15 cm	1	1	236.00
421 73 10	GN: 1/1, H: 10 cm	1	1	358.00
421 73 15	GN: 1/1, H: 15 cm	1	1	393.00
421 71 50	Abtropf-Platte, GN: 1/3	1	1	18.00
421 72 50	Abtropf-Platte, GN: 1/2	1	1	23.00
421 73 50	Abtropf-Platte, GN: 1/1	1	1	36.00

Vakuum-Siegelrandbeutel zum Schweissen

Konservierungsbeutel mit hoher Reissfestigkeit, Qualität PA / PE 20/70

		Stück		1	
				52.00	20 %
441 41 18	13 x 18 cm	1	1000	41.60	
441 41 25	10 x 25 cm	1	1000	44.80	
441 41 20	15 x 20 cm	1	1000	52.80	
441 41 26	20 x 25 cm	1	1000	88.00	
441 42 26	15 x 26 cm	1	1000	69.60	
441 42 30	20 x 30 cm	1	1000	105.60	
441 42 35	25 x 35 cm	1	1000	155.20	
441 42 36	30 x 35 cm	1	1000	185.60	
		Stück	1	3	6
				10 %	20 %
441 40 40	25 x 40 cm	1	1000	224.40	201.96
					179.52



Vakuum-Siegelrandbeutel sous-vide

Kochfest, temperaturbeständig bis 115°C, Qualität PA / PE 20/70

		Stück		1	
				99.00	20 %
441 46 20	15 x 20 cm	1	1000	79.20	
441 46 25	17 x 25 cm	1	1000	79.20	
441 46 30	25 x 30 cm	1	1000	180.00	
441 46 41	30 x 40 cm	1	600	199.20	



Plastik-Gefriersäcke

Mit starker Bodenschweißnaht

		Stück	1	12	25
				5 %	10 %
441 48 45	25 x 45 cm	1	50	4.00	3.80
441 48 60	40 x 60 cm	1	50	12.80	12.16
					11.52



Datierautomat Meto

Klare Daten für Selbstkontrolle, speziell für das Gastgewerbe mit 2 Daten. Das Gerät ist aus bruchfestem Kunststoff

Ersatzrollen:

Etiketten vorgedruckt: "In den Kühler" und "zu verbrauchen bis"

		Stück		1
421 60 00	25 x 5 cm, H: 17.8 cm	1	1	450.00
421 60 50	Ersatzrolle mit 1200 Haftetiketten	1	1200	14.80



Magic-Saver® Tellerstapler

Mit rutschfestem Doppelstapelring für alle Tellergrößen von 16 - 32 cm Ø, platzsparend, es können 5 Magic-Saver ineinander gestapelt werden. Design brunelli

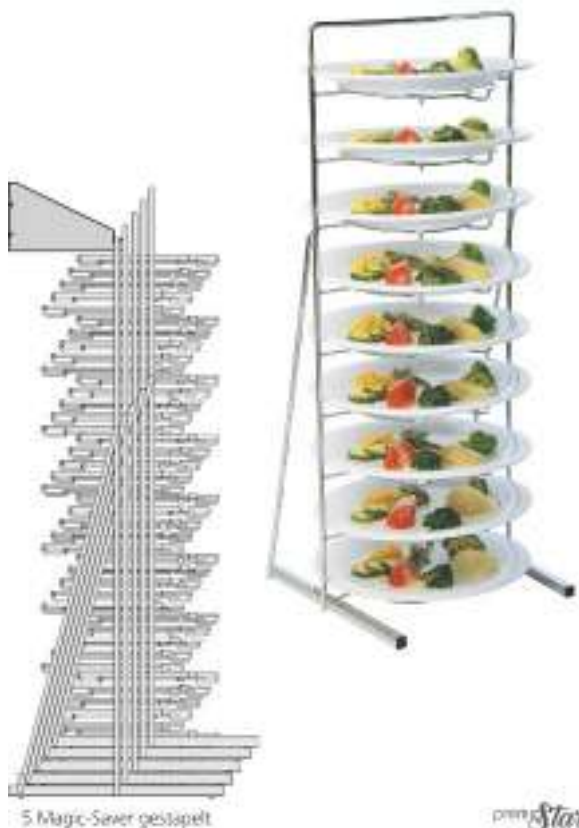

5 Magic-Saver gestapelt

Magic-Saver® Tellerstapler

Für 9 Teller von 16 - 32 cm Ø, Metalldraht verchromt, pro 5 Magic Saver erhalten Sie eine Wandhalterung aus Chromnickelstahl gratis im Wert von CHF 42.--

			Stück	1	
					10 %
441 29 00	35.5 cm, 32 cm, H: 83 cm	1	1	89.00	80.10
			Stück	1	
					20 %
441 29 01	5 Magic-Saver inkl. Wandhalterung CNS	1	1	487.00	389.60

Marken und Modellschutz



Magic-Saver® Wandhalterung

5 Magic-Saver Tellerstapler können einzeln angehängt bzw. weggenommen werden. Chromnickelstahl, inklusive Schrauben/Dübel

			Stück	1	
441 29 50	17 cm, 30 cm, H: 10 cm	1	1		42.00

Magic-Saver® Einweg-Hüllen



			Stück	1	
620 11 70	Plastik-Schutzhüllen, 70 l, H: 92 cm	1	400		50.90

Küche

Tellerstapler Plate Mate

Sparen Sie Platz mit dem flexiblen Tellerstaplersystem

Einfache Einstellung mittels Drehknopf für alle Teller, Platten etc. bis zu 5 cm Höhe

		Stück		1
				10 %
441 30 24	Tischmodell für 24 Teller, H: 73 cm	1	1	560.00 504.00
441 30 36	Tischmodell für 36 Teller, H: 93 cm	1	1	695.00 625.50
441 31 06	Wandmodell für 6 Teller, H: 57 cm	1	1	200.00 180.00
441 31 09	Wandmodell für 9 Teller, H: 77 cm	1	1	255.00 229.50
441 31 12	Wandmodell für 12 Teller, H: 99 cm	1	1	305.00 274.50



Tellerstapler Plate Mate, Wagen

Grundfläche 50 x 50 cm

Der einzige zusammenklappbare Tellerstapler

		Stück		1
				10 %
441 32 60	Für 60 Teller, H: 149 cm	1	1	1295.00 1165.50
441 33 01	Tellerwagen-Hülle Kunststoff	1	1	325.00 292.50
441 32 84	Für 84 Teller, H: 190 cm	1	1	1575.00 1417.50
441 33 02	Tellerwagen-Hülle Kunststoff	1	1	375.00 337.50



Tellerstapler Plate Mate Heavy-Duty, Wagen

Grundfläche 70 x 70 cm

Der einzige zusammenklappbare Tellerstapler

Der "Heavy Duty" Tellerwagen eignet sich für Teller und Schalen aller Art und Grössen

		Stück		1
				10 %
441 35 84	Für 84 Teller, H: 189 cm	1	1	2295.00 2065.50
441 35 01	Tellerwagen-Hülle Kunststoff	1	1	490.00 441.00



Rezeptions- und Küchenglocke

		Stück		1
				30 %
800 70 05	mit schwarzem Metallfuss, Ø 8.5 cm	1	1	12.00 8.40
800 70 00	mit Holzfuss, Ø 9 cm	1	1	19.00 13.30



1440.-



Saladette

Spitzentechnik mit kompakten Abmessungen

- Betriebstemperatur von 0 bis +10°C, eigengekühlt
- Innen und aussen aus CNS
- Automatische Tauwasserverdunstung
- Mikroprozessorsteuerung mit digitaler Temperaturanzeige
- Gleichmässige Temperaturverteilung dank Umluftkühlung
- Inklusive 5 Zwischenstege

431 63 00	Inhalt: 260 Liter, 90 x 70 cm, H: 87 cm, 230 V, 204 W, 61.6 kg	Stück 1 1	1 1440.00
------------------	---	---------------------	---------------------



Mini-Kühltisch mit Umluftkühlung

CNS 18/10

- 2 Türen mit je 3 Auflageschienen für GN 1/1
- Elektronische Steuerung
- Tauwasserverdunstung
- Inhalt 260 l
- Temperaturbereich 0° - 10° C
- Mit eingeschäumtem Verdampfer

431 58 00	Inhalt: 260 Liter, 90 x 70 cm, H: 87 cm, 230 V, 204 W, 60.2 kg	Stück 1 1	1 1660.00
------------------	---	---------------------	---------------------



Kühlschrank für 2/1 GN Roste

Automatischer ECO-Modus, Abtau- und Lüfter-Steuerung, LCD-Display, 90 mm Isolation, Innenbereich: Beleuchtung und Auflagerippen, tiefgezogene Bodenwanne für einfache Reinigung, Türanschlag rechts, 3 Tragroste inklusive

Stockwerklieferung inkl. Entsorgung des bestehenden Gerätes, pauschal CHF 450.-

432 54 10	Volltüre mit Rollfüsse, Bruttoinhalt: 580 Liter cm, H: 205 cm, 72 x 84 cm, 230 V, 1150 W, -2 / +12 °C	Stück 1	1 2900.00
432 54 11	Glastüre mit Stellfüsse, Bruttoinhalt: 580 Liter, 72 x 84 cm, H: 205 cm, 230 V, 1150 W, -2 / +12 °C	1	3500.00



Tiefkühlschrank für GN 2/1

Automatischer ECO-Modus, Abtau- und Lüfter-Steuerung, LCD-Display, 90 mm Isolation, Innenbereich: Beleuchtung und Auflagerippen, tiefgezogene Bodenwanne für einfache Reinigung, Türanschlag rechts, 3 Tragroste inklusive

Stockwerklieferung inkl. Entsorgung des bestehenden Gerätes, pauschal CHF 450.-

432 54 20	Volltüre mit Rollfüsse, Bruttoinhalt: 580 Liter, 72 x 84 cm, H: 205 cm, 230 V, 4600 W, -15 / -22 °C	Stück 1	1 3300.00
432 54 21	Glastüre mit Stellfüsse, Bruttoinhalt: 580 Liter, 72 x 84 cm, H: 205 cm, 230 V, 4600 W, -15 / -22 °C	1	4100.00

Küche

GN Rost CNS 18/10

Rost ohne Füße

		Stück	
441 94 11	Einschubrost, GN: 1/1, 53 x 32.5 cm	1	35.00
441 94 21	Einschubrost, GN: 2/1, 65 x 53 cm	1	52.90



Backblech Aluminium, gelocht

		Stück	
441 60 11	GN: 1/1, 32.5 x 53 cm, H: 1 cm	1	48.00
441 60 21	GN: 2/1, 56 x 65 cm, H: 1 cm	1	75.00
441 60 50	GN 1/1, Steg zu Backblech	1	11.00



Backtrennfolie

Glasgewebefolie mit Teflonbeschichtung

		Stück	
441 65 11	50 x 31.5 cm, Rolle à 10 Stück	1	79.50



Backtrennfolie Exopat

Robuste Fiberglas-Silikon-Folie

		Stück	
465 40 52	GN: 1/1, 52 x 31.5 cm	1	37.00
465 40 58	58.5 x 38.5 cm	1	48.00
465 40 62	62 x 42 cm	1	53.00



ab
37.-

Backtrennpapier

Beidseitig silikonisiert, fettdicht in Cutterbox

		Stück	
465 41 45	45 cm, Länge 100 m	1	29.00



Backpapier Backstar Profi Gastronorm

Hochwertiges, für Laugengebäck geeignetes Papier in Gastronorm, für höchste Ansprüche, Compactbox für Einhandbedienung

		Stück	
465 48 11	GN: 1/1, 32.5 x 53 cm	1 300 1 =	39.80 0.13
465 48 21	GN: 2/1, 52 x 64 cm	1 250 1 =	59.00 0.24



Backtrennpapier Silipal

Silipal, beidseitig silikonisiert, weiss, fettdicht, 50 g/m2

		Stück	
465 42 25	25 x 37 cm, ca. 3.1 kg (650 Stk.)	1	31.00
465 42 75	75 x 100 cm, 1 kg	1	16.90
465 43 00	Zuschlag Spezialmass 1 kg	10	0.70



Kuchenbleche

Blaublech, nicht spülmaschinengeeignet

		Stück	
441 66 16	16 cm Ø	1	3.90
441 66 20	20 cm Ø	1	4.50
441 66 24	24 cm Ø	1	5.50
441 66 26	26 cm Ø	1	5.90
441 66 28	28 cm Ø	1	6.50
441 66 32	32 cm Ø	1	7.90
441 66 36	36 cm Ø	1	8.90



ab
34.40



Backblech GN 1/1

Silikon beschichtet

Gelocht Ø 3 mm, Materialstärke 1,5 mm, temperaturbeständig bis 240°C

	Stück	1	10 %	20 %
425 14 11 GN: 1/1	1	1	43.00	34.40

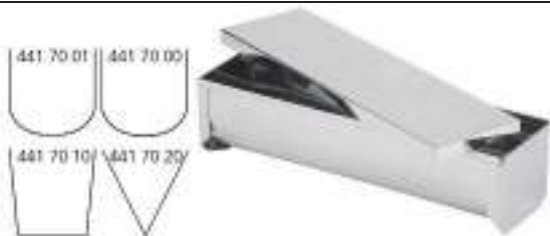

Terrineform CNS 18/10

Mit Deckel

	Stück	1	10 %	20 %
441 70 01 0.5 l, 28 x 5.5 cm, H: 5 cm	1	1	52.00	41.60
441 70 00 1.25 l, 28 x 7.5 cm, H: 7 cm	1	1	41.00	32.80
441 70 10 1.6 l, 28 x 7 cm, H: 8 cm	1	1	52.00	41.60
441 70 20 0.7 l, 26 x 8 cm, H: 5 cm	1	1	46.00	36.80



Tortenringe

CNS

	Stück	1	10 %	20 %
441 67 28 H: 3.5 cm, 28 cm Ø	1	1		93.00
441 67 00 verstellbar für alle Kuchengrößen, H: 7 cm, 16 - 31 cm Ø	1	1		17.00



Savarin-Form

Weissblech

	Stück	1	10 %	20 %
441 71 08* 8 cm Ø, H: 3 cm	1	1	5.60	4.48



Keksform Eifa

Leichtmetall, auf gewünschte Länge ausziehbar

	Stück	1	10 %	20 %
441 68 00 22 - 38 x 10.5 cm, H: 7 cm	1	1		16.90



Pasteten-Backform

Mit Deckel, Gusseisen, emailliert

	Stück	1	10 %	20 %
400 58 32* 32 x 11 cm, H: 11 cm	1	1	229.00	206.10



Teigwaller Edelstahl

Gelagert mit Antihafbeschichtung, mit verchromtem Wegräumständer

	Stück	1	10 %	20 %
441 92 47 Walzenlänge 25 cm, 47 cm, 6 cm Ø	1	1	61.00	48.80



Teigwaller

Auf Kugellager, Griffe Ahornholz

	Stück	1	10 %	20 %
441 85 35 Walzenbreite 35 cm, 64 cm, 8 cm Ø	1	1		91.00



Teigschaber

Griff Exoglass, Spachtel Thermoplastik

	Stück	1	10 %	20 %
441 86 25 Bis 110°C, 25 cm, 4 x 11 cm	1	1		9.80
441 86 35 Bis 110°C, 35 cm, 7 x 11.5 cm	1	1		12.00
441 91 35 Bis 260°C, 35 cm, 7 x 11.5 cm	1	1		27.00

Küche

Teigschaber rechteckig

Polypropylen

Artikelnummer	Maße	Stück	Preis
441 93 12	12 x 9.6 cm	6 Stück	1.80



Eierpinsel

Stiel aus Exoglass, hitzebeständig, spülmaschinenfest

Artikelnummer	Maße	Stück	Preis
441 89 30	3 cm	1 Stück	6.40
441 89 40	4 cm	1 Stück	7.20
441 89 50	5 cm	1 Stück	8.80



Silikon-Backpinsel

Stiel aus Edelstahl, hitzebeständig bis 260°C

Artikelnummer	Maße	Stück	Preis
441 59 03	4 cm, 24.5 cm	1 Stück	7.60



Teigrädchen CNS

Artikelnummer	Maße	Stück	Preis
441 90 02	Gewellt, 19 cm, 5.8 cm Ø	1 Stück	3.50



Dariol-Formen

Speziell für Mousse und Flans, rostfreier Edelstahl

Artikelnummer	Maße	Stück	Preis
441 85 45	45 mm Ø, H: 43 mm	6 Stück	43.20
441 85 55	55 mm Ø, H: 55 mm	6 Stück	47.20
441 85 65	65 mm Ø, H: 65 mm	6 Stück	52.00



Dariol-Formen

Speziell für Mousse und Flans, rostfreier Edelstahl

Artikelnummer	Maße	Stück	Preis
441 63 55	55 mm Ø, H: 47 mm, 0.08 l	4 Stück	9.50
441 63 62	62 mm Ø, H: 47 mm, 0.09 l	4 Stück	10.00
441 63 70	70 mm Ø, H: 35 mm, 0.35 l	4 Stück	12.00
441 63 85	85 mm Ø, H: 50 mm, 0.02 l	4 Stück	19.00



Präsentations Ringe

Für die Präsentation der Speisen, Edelstahl mattiert, fugenlos
4 Formen und 1 Verdichter

Artikelnummer	Maße	Stück	Preis
442 00 06	Set à 5 Stück, 6 cm Ø, H: 4.5 cm	5 Stück	23.20
442 00 08	Set à 5 Stück, 8 cm Ø, H: 4.5 cm	5 Stück	24.80



Ausstecher

Rund, Satz aus Exoglass, hitzebeständig bis 160°C

Artikelnummer	Maße	Stück	Preis
441 75 00	Glatt, 8-teiliger Satz, 3 - 10 cm Ø, H: 3.5 cm	8 Stück	87.00
441 76 00	Gezackt, 9-teiliger Satz, 2 - 10 cm Ø, H: 3.5 cm	9 Stück	123.00





Ausstecher 12-teilig, gezackt

Satz aus Edelstahl, rund
Ø 25 - 105 mm

420 00 04 gezackt, H: 5 cm

Stück
1 12

1
19.80



Ausstecher 12-teilig, rund

Satz aus Edelstahl, rund
Ø 25 - 105 mm

420 00 03 glatt, H: 5 cm

Stück
1 12

1
19.80



Mehlsieb

CNS

441 87 35 35 cm Ø, H: 8 cm

Stück
1 1

1
~~46.00~~ 36.80
20 %



Tortengitter

Edelstahl rostfrei, elektropoliert

441 96 32 35 cm Ø

Stück
1 1

1
~~23.00~~ 20.70
10 %



Kandiergitter CNS

Einschub-Rost, Höhe mit Füße 2.3 cm

441 95 11 GN: 1/1, 53 x 32.5 cm

Stück
1 1

1
~~58.10~~ 52.29
10 %



Tortenteiler

CNS, Ø 32 cm

441 97 12 Teilung: 12, H: 3.5 cm

Stück
1 1

1
~~62.00~~ 49.60
20 %



Silikon-Backformen

Aus reinem Silikon, spülmaschinenfest, geruchs- und geschmacksneutral, temperaturbeständig von -40°C bis +250°C

Format: 30 x 17.5 cm

444 02 00 Halbkugel, 7 cm Ø, H: 3.5 cm

444 02 01 Muffins, 6.9 cm Ø, H: 3.5 cm

444 02 02 Madeleine, 6.8 x 4.5 cm, H: 1.7 cm

444 02 03 Gugelhopf, 7 cm Ø, H: 3.5 cm

Stück

1 1
1 1
1 1
1 1

1
20 %
~~16.00~~ 12.80
~~16.00~~ 12.80
~~16.00~~ 12.80
~~16.00~~ 12.80



Silikon-Backformen

Aus reinem Silikon, spülmaschinenfest, geruchs- und geschmacksneutral, temperaturbeständig von -40°C bis +220°C

Format: 30 x 17.5 cm

441 62 00* Mini Rechteck, 8 x 3 cm, H: 3.3 cm

Stück

1 1

1
20 %
~~22.90~~ 20.61

Küche

Dressiersäcke

Baumwollgewebebeschicht mit Doppelspitze, weiss, kochfest, Aufhänger und Aussensaum

		Stück		
441 80 28	28 cm	1	1	5.50
441 80 34	34 cm	1	1	6.50
441 80 40	40 cm	1	1	8.00



Einweg-Dressiersäcke

Sie schneiden den Sack auf die passende Grösse, Niederdruck Polyäthylen-Spitztüte, transparent

		Stück		
441 81 00	30 x 55 cm	1	200 100 =	47.00 23.50



Garnier-Tüllen

Polycarbonat, hygienisch, Satz mit 6 Lochtüllen Nr. 3, 5, 7, 9, 11, 13 und 6 Sterntüllen C6, C7, D8, E7, F7, F8

		Stück		
441 82 00	Set à 12	1	12	67.00 53.60 20 %



Sterntüllen-Satz CNS

10-teilig, 4, 5, 6, 7, 8, 9, 10, 11, 12, 13 und 15 mm

		Stück		
441 79 00	Set à 10	1	10	42.00 33.60 20 %



Lochtüllen-Satz CNS

10-teilig, 4-10 + 12-13 + 15 mm

		Stück		
441 79 01	Set à 10	1	10	42.00 33.60 20 %



Streuer

CNS, H: 10.5 cm, 7 cm Ø

		Stück		
441 72 00	Gewürz-/Salz-/Zuckerstreuer, H: 10.5 cm, 7 cm Ø	1	1	9.50
441 73 00	Pudertzucker-/Kakaostreuer, H: 10.5 cm, 7 cm Ø	1	1	9.50



Schaufel

Kunststoff, für Zucker, Mehl, Eiswürfel etc.

		Stück		
320 20 10	weiss, 28.5 x 13 cm, H: 6.5 cm, 1 l	1	1	5.00
320 20 22	weiss, 36 x 14 cm, H: 9 cm, 2.2 l	1	1	9.30
320 21 00	transparent, 25 x 6 cm, H: 5 cm, 0.17 l	1	1	11.70



Kaffeefilter Melitta

		Stück		
460 55 17	Rundfilter, gepresste Baumwollwatte, 167 mm Ø	1	400	60.00
460 55 21	Rundfilter, gepresste Baumwollwatte, 207 mm Ø	1	100	21.00
460 56 01	No 202s	1	100	11.90
460 56 03	No 220	1	100	48.30
460 57 00	Korbfiltertüten, 250/90 mm, für Ani- mo, Bravilor, Cory, Novorex, WMF etc.	1	1000	63.00





Kisag ISI Whip aus Edelstahl

Edelstahlflasche, Metallkopf, Flasche spülmaschinenfest

		Stück		1
				20 %
450 03 05	0.5 l, Gourmet-Whip, für Kisag Patronen	1	1	149.00 119.20
450 03 10	1.0 l, Gourmet-Whip, für Kisag Patronen	1	1	169.00 135.20
450 04 05	0.5 l, Thermo-Whip, doppelwandig, für Patronen Kisag	1	1	179.00 143.20
		Stück		1
450 11 00	Patronen Kisag zum Aufstecken	1	50	49.00 44.10



Kisag Rahmbläser-Patronen

Einwegkapseln zum Aufstecken! Für Kisag

		Stück		1
				10 %
450 11 00	Patronen Kisag zum Aufstecken	1	50	49.00 44.10



International Rahmbläser-Patronen

Einwegkapseln zum Aufschrauben! Für Whipper ISI, Kaiser, LISS, etc.

		Stück		1
				30 %
450 10 00	Patronen International zum Aufschrauben	1	50	48.00 33.60



Vermicelles-Pressse

		Stück		1
441 99 00	Handpresse CNS	1	1	169.00
		Stück		1
441 98 00	Presse mit 2 Form-Einsätzen	1	1	699.00 594.15



Dosiertrichter aus Polycarbonat

Leicht und handlich, erleichtertes Einfüllen und Dossieren von flüssigen Produkten wie Crèmes, Saucen etc., inkl. Halterung aus verchromtem Metall, spülmaschinenfest

		Stück		1
				20 %
441 74 00	0.75 l	1	1	109.00 87.20
441 84 00	1.5 l	1	1	218.00 174.40



Dosiertrichter CNS

Trichter aus CNS mit 3 Tüllen (2, 4 und 6 mm), ergonomischer Griff aus Kunststoff, inkl. Ständer und Auffangschale

		Stück		1
				20 %
441 84 02	1.5 l	1	1	165.00 132.00

132.-

Küche

Glace-Maschine

Inhalt: ca. 1.4 Liter, Eis-Produktion: ca. 30-60 Minuten

- Gehäuse aus Edelstahl und Kunststoff
- herausnehmbarer Eisbehälter, antihafbeschichtet,
- Gefrierbereich bis ca. -35° C, Kompressorkühlung
- inklusive Messbecher und Eisportionierer

Gerät ist nicht für den dauerhaften gewerblichen Einsatz geeignet



		Stück		
450 33 00	29.5 x 39.5 cm, H: 31.5 cm, 230 V, 150 W, 10.6 kg	1	1	395.00

Glace- oder Reis- Portionierer oval

CNS 18/10

		Stück		
450 33 30	1/30 l, 55 x 40 mm	1	1	14.90



Glace- oder Reis- Portionierer Stöckel

CNS 18/10, mit Messinggriff verchromt

		Stück		
450 32 20	1/20 l, 56 mm Ø	1	1	53.21
450 32 24	1/24 l, 51 mm Ø	1	1	53.21
450 32 30	1/30 l, 49 mm Ø	1	1	53.21
450 32 70	1/70 l, 35 mm Ø	1	1	53.21



Glace-Dipper

Alu, schwarz beschichtet, mit wärmeleitender Flüssigkeit im Griff

		Stück		
450 31 20	1/20 l	1	1	16.00
450 31 24	1/24 l	1	1	15.20



Gebäck-Zange

CNS 18/8, universelle Zange für Confiserie, Pralinés, Pâtisserie etc.

		Stück		
450 36 00	17.5 cm	1	1	18.40



Tortenheber CNS 18/10

		Stück		
450 35 00	22 cm	1	1	12.00



Pâtisserieskapseln

		Stück		
460 25 40	40 mm Ø	1	1000	9.92
460 25 45	45 mm Ø	1	1000	10.72



Diplomatkapseln

		Stück		
460 21 56	Mini, 40/56 mm Ø, H: 30 mm	1	1000	59.80
460 21 72	Midi, 57/72 mm Ø, H: 28 mm	1	1000	105.00





Torten-Scheiben

Karton, weiss

460 15 28 28 cm Ø

Stück

1 500
100 =

1
20 %
~~104.00~~ 83.20



Pâtisserie Kartonteller

700 41 13 13 x 13 cm

Stück

1 250
100 =

1
12.90
5.16

700 40 11 11 x 17 cm

1 250
100 =

12.00
4.28

700 40 13 13 x 20 cm

1 250
100 =

14.00
4.92



hulu Tortenschnitten-Papiere

Silipal-Papier, fett dicht, die Tortenschnitten kippen nicht und werden durch den Saft anderer Stücke nicht aufgeweicht

460 30 22 22 x 14, oval cm

Stück

1 600
100 =

1
24.00
4.00



Pâtisserie Ausstellplatten Supra-Luran

460 38 28 Supra-Luran, 28 x 20 cm

Stück

1 1

1
12
5 %
13.78
10 %
13.05



Gebäck- und Tortenglocken

Glasklar, Material Luran

460 35 28 Glocke klar, 28 cm Ø, H: 10 cm

Stück

1 1

1
11.90



hulu Lunch-Tragtaschen

460 50 00 T: 10 cm, 20 x 28 cm

Stück

1 250
100 =

1
74.40
29.76



Pizza-Boxen

Hart-Wellpappe mit Dampföchern, rot bedruckt, mit Öffnungsglasche.

460 00 29 29 x 29 cm, H: 3 cm

Stück

1 200
1 =

1
8
10 %
62.10
25 %
51.75
0.26

460 00 32 32 x 32 cm, H: 3 cm

Stück

1 150
1 =

1
10
10 %
57.60
25 %
48.00
0.32

460 01 30 Calzone, 30 x 16 cm, H: 10 cm

1 150

64.00
0.43
62.10
51.75

460 01 50 Familie, 50 x 50 cm, H: 5 cm

Stück

1 50

1
69.00

1 Stück ab
0,26

Küche

Körbchen für Pommes frites, Früchte etc.

Falt-Schachteln, weiss

Art-Nr.	Abm.	Stück	100 =	1
465 18 13	13 x 9 cm, H: 5.5 cm, 250 g, No 1	1	100	19.80



hulu Poulet-Papiere

Back-Trennpapier Silpal, beidseitig silikonisiert, weiss, fettdicht, 50g/m2

Art-Nr.	Abm.	Stück	100 =	1
465 00 32	oval, 32 x 20 cm	1	600	37.80 6.30
465 00 36	oval, 36 x 23 cm	1	600	55.80 9.30
465 01 30	30 cm Ø	1	600	73.00 12.17



Poulet-Körbchen

Bambusgeflecht, passendes Pouletpapier Art.-Nr. 465 00 36

Art-Nr.	Abm.	Stück	100 =	1
465 05 25	oval, 25 x 18 cm	1	1	2.34 3.90 40 %



Poulet-Körbchen Chromstahl

Art-Nr.	Abm.	Stück	100 =	1	12	30
211 20 26	26 x 18.5 cm, H: 4 cm	1	1	13.00	11.70 10 %	10.40 20 %



Citro-Feuchtservietten

Zum Reinigen der Hände und zur Erfrischung. Tüchlein 13.8 x 18.2 cm

Art-Nr.	Stück	1000	1
465 15 00	1	1000	85.00



Poulet-Manschetten

Art-Nr.	Abm.	Stück	100 =	1
465 11 00	15 x 50 mm	1	250	63.00 23.92



Seitenfalten-Beutel

Art-Nr.	Abm.	Stück	1000	1
460 47 24	T: 7 cm, 24 x 12 cm	1	1000	44.10 63.00 30 %
460 47 34	T: 9 cm, 34 x 17 cm	1	1000	65.80 94.00



Gebäckbeutel

Kreuzbodenbeutel glasklar, reissfest, 40 my

Art-Nr.	Abm.	Stück	100 =	1
460 40 24	20 x 29 cm	1	500	59.80 11.96



Brötchen-Beutel

Polypropylen perforiert, Block à 100 Stück

Art-Nr.	Abm.	Stück	1000 =	1
460 45 28	28 x 12 cm	1	2400	109.60 45.67
460 45 20	20 x 16 cm	1	2400	109.60
460 45 35	35 x 24 cm	1	2000	159.90 79.95





Schnüre

Hanf

		Stück	1	10	30
465 22 01	Packschnur, 200 g, Hanf, dick	1	1	14.90	14.60 2 %
465 22 02	Packschnur, 200 g, Hanf, mittel	1	1	14.30	14.01 5 %



Traiteurschnur

Hanfbindfaden weiss, poliert

		Stück	1	3	6
465 23 00	160 m, 100 g	1	10 1 =	65.00 6.50	58.50 5.85 20 %
465 24 00	Traiteurschnur in praktischer Dose mit Abschneider	1	1		8.50 1



Offene Zahnstocher

Holz, beidseitig gespitzt, rund, auch zum Fixieren von Fleischstücken wie Cordon bleu, Fleischvögel etc.

		Stück	1
330 25 00	68 mm, 2 mm Ø	1	5000 1000 =
			9.90 1.98



Bambus-Fleischspiessli

		Stück	1
465 27 20	20 cm, 0.25 cm Ø	1	1000
			14.70

12.53



Fleischspieß Schwert

Edelstahl, geschmiedet

		Stück	1
465 31 31	31 cm	10	1
			17.90 30 % 12.53



Grillspieß Herkules

Edelstahl 18/10, seidenmatt gebürstet, Vorrichtung zum Aufhängen, bewegliche Abstreifehilfe, gedrehte Spitze verhindert das Abgleiten des Grillguts spülmaschinengeeignet

		Stück	1
465 31 45	Länge: 45 cm, Klingenlänge: 32 cm	4	1
			9.40 20 % 7.52



Maiskolben-Halter

Griff in Maiskolbenform mit 2 Festhalte-Spitzen

		Stück	1
465 30 30	7 cm	1	30
			14.90



Frischhaltefolie mit Abreisscoupons

		Stück	1
466 06 28*	28 x 28, 500 m	1	1
466 06 35*	35 x 35, 500 m	1	1
			23.90 30 % 16.73
			26.00 18.20

Küche

Frischhaltefolie in Cutterbox

Glasklar, dehnbar, Rolle à 300 m

		Stück	1	12	30
				10 %	20 %
466 00 30	30 cm	1	14.80	11.84	11.84
466 00 45	45 cm	1	19.60	15.68	15.68



ab
11.84

Aluminiumfolie in Cutterbox

Rolle à 150 m

		Stück	1	12	30
				10 %	20 %
466 10 30	30 cm	1	29.80	26.82	23.84
466 10 45	45 cm	1	44.00	39.60	35.20



Frischhaltefolie Jet-Cut

Glatt, faltenfrei, blitzschnell und messerscharf dispensert Jet-Cut die transparente Haftfolie.

Rolle à 300 m

		Stück	1	12	30
				5 %	10 %
466 01 30	30 cm, Einwegbox	1	22.50	21.38	20.25
466 01 45	45 cm, Einwegbox	1	29.50	28.03	26.55



Frischhaltefolie, offene Rollen

Glasklar, dehnbar, Rolle à 300 m

		Stück	1	12	30
				10 %	20 %
466 17 30	30 cm	1	45.90 11.48	41.31 10.33	36.72 9.18
466 17 45	45 cm	1	74.20 18.55	66.78 16.70	59.36 14.84



Dispenser Jet-Cut CNS

Glatt, faltenfrei, blitzschnell und messerscharf dispensert Jet-Cut die transparente Haftfolie.

Rolle à 500 m

		Stück	1	12	30
				5 %	10 %
466 02 30	30 cm, Dispenser Jet Cut CNS	1			85.00
466 02 45	45 cm, Dispenser Jet Cut CNS	1			98.00
466 03 30	30 cm, Nachfüllrollen PE 500 m	4	26.50	25.18	23.85
466 03 45	45 cm, Nachfüllrollen PE 500 m	4	34.50	32.78	31.05



TOP

Folien-Abreisshalter für 2 Rollen

Robuste Ausführung mit solidem Messer

		Stück	1
466 20 48	48 cm	1	74.00



Wrapmaster-System

		Stück	1	12	30
				5 %	10 %
466 15 30	30 cm, PE Wrapmaster	1	142.00		
466 15 45	45 cm, PE Wrapmaster	1	175.00		
466 16 30	30 cm, Alu Wrapmaster	1	129.00		
466 16 45	45 cm, Alu Wrapmaster	1	175.00		
466 23 30	30 cm, PE-Folie 500 m	1	55.00 24.90	52.25 26.13	49.50 24.75
466 23 45	45 cm, PE-Folie 500 m	1	77.00 34.90	73.15 36.57	69.30 34.65
466 19 30	30 cm, Alu-Folie 90 m	1	65.00 19.67	61.75 20.58	58.50 19.49
466 19 45	45 cm, Alu-Folie 90 m	1	97.00 29.50	92.15 30.87	87.30 29.25





Einweg-Kochmützen

Hochnassfest, mit aufgedruckter dezenter Faltschattierung, auf jede Kopfgrösse einstellbar

		Stück	1	10	30
468 04 00	Police-Mütze, H: 8.8 cm	1	100	40.20	36.18
					10 %
468 02 00	Falten-Toques, H: 24 cm	1	200	186.00	167.40
			100 =	93.00	83.70
468 02 10	Falten-Toques, H: 24 cm	1	10		10.50
					3
468 00 00	Europa, H: 21 cm	1	250	179.00	161.10
			100 =	68.84	64.44
468 00 50	Europa, H: 21 cm	1	50		38.00
					3
				10 %	15 %

1 ab
11.50



Chef-Schürzen

100 % Baumwolle, Halbleinen, Zwirnkette

		Stück	1
468 15 50	Halbleinen, 50 cm	1	10
			1 =
468 15 70	Halbleinen, 70 cm	1	10
			1 =
468 17 70	Halbleinen, ohne Bündel, 70 cm	1	10
			1 =
468 15 90	Halbleinen, 90 cm	1	10
			1 =
468 16 90	Halbleinen, mit Latz, 90 cm	1	10
			1 =

Casserolier-Schürze

100 % Baumwolle, dunkelblau, 100 cm



		Stück	1	10	30
468 18 00	Casserolier-Schürze, blau	1	1	18.50	16.65
					10 %

Schürzenbänder

100 m, 16 mm breit



		Stück	1
468 20 01	rohweiss	1	1
468 20 45*	rot	1	1

Küche

Hygiene-Einweg-Handschuhe

Polyäthylen transparent, geprägt

		Stück	1	10	30
401 77 01	Grösse M mittel	1	100	2.20	1.98
401 77 02	Grösse L gross	1	100	2.20	1.98
				10 %	20 %
				1.76	1.76



Hygiene-Einweg-Handschuhe Latex schwarz

puderfrei

		Stück	1	10	30
401 72 01	Grösse M mittel	1	100	14.90	13.41
401 72 02	Grösse L gross	1	100	14.90	13.41
				10 %	20 %
				11.92	11.92



Hygiene-Einweg-Handschuhe Latex

		Stück	1	10	30
401 78 01	Grösse M mittel	1	100	14.90	13.41
401 78 02	Grösse L gross	1	100	14.90	13.41
				10 %	20 %
				11.92	11.92



Thermo-Servierhandschuhe

100% Baumwolle weiss, auf der Innenseite weisse Antirutsch-Gumminoppen

		Stück	1	10	30
468 25 01	Grösse M	1	1		4.90
468 25 02	Grösse L	1	1		4.90



Passier-Tücher

100% Leinen

		Stück	1	4	10
401 75 00	85 x 90 cm	1	3	56.80	51.12
			1 =	18.93	17.04
					20 %
					45.44
					15.14



Chef-Torchons

100% Baumwolle, Zwirnkette, écru

		Stück	1	12	30
468 26 85	45 x 85 cm	1	10	39.00	35.10
				10 %	20 %
					31.20



hulu Handtuchspender

Kunststoff weiss, mit Schloss

Midi bis zu 160 Handtücher

Maxi bis zu 280 Handtücher

		Stück	1	10	30
611 56 01	Midi, 29 x 14.5 cm, H: 26.5 cm	1	1		45.00
611 55 01	Maxi, 29 x 14.5 cm, H: 42.5 cm	1	1		52.00



Non-Stop-Sky Handtücher 2-lagig

Spezialfaltung, die pro Handgriff nur ein einziges Handtuch frei gibt! Es ist nicht möglich, mehrere Handtücher auf einmal herauszuziehen. Bis 30 % weniger Verbrauch, bis 30 % günstiger, weniger oft nachfüllen

Geprägt, 23.5 x 24 cm, ungebleicht, EU Ecolable

		Stück	1	10	21
610 59 22	Lagen: 2, 2 x 21.5 g/m ²	1	3000	35.00	31.50
			1000 =	11.67	10.50
					25 %
					26.25
					8.75



1 Rolle ab
3,54



hulu Küchen Tissue-Rolle 1-lagig

100% reine weisse Zellulose, Endlosrolle

		Stück	1	18	36
466 40 15	Mini, für Spender 4664800, 120 m, 20 cm	1	15 1 =	66.50 4.10	59.85 3.98
				10 %	20 %
					53.20 3.54
466 45 00	Maxi, für Spender 4664900, 320 m, 22 cm	1	6 1 =	51.00 8.50	45.90 7.65
				10 %	20 %
					40.80 6.80

Küchentissue-Spender

Mit Schloss



		Stück	1	
466 48 00	Mini, H: 27 cm, 16 cm Ø	1	1	29.00
466 48 20	Midi, H: 30 cm, 20 cm Ø	1	1	34.00
466 49 00	Maxi, H: 34 cm, 26 cm Ø	1	1	39.00

hulu Küchen Tissue-Rolle 2-lagig

100% reine weisse Zellulose, perforiert



		Stück	1	20	40
466 43 13	Tissue-Rollen Mini, für Spender 4664800, 70 m, 2-lagig, 13 cm Ø	1	12	49.00	44.10
				10 %	20 %
					39.20
466 43 18	Tissue-Rollen Midi, für Spender 4664820, 90 m, 2-lagig, 18 cm Ø	1	6	39.00	35.10
				10 %	20 %
					31.20
466 43 24	Tissue-Rollen Maxi, für Spender 4664900, 180 m, 2-lagig, 24 cm Ø	1	3	39.00	35.10
					31.20

hulu Küchenrolle 2-lagig

100 % reine weisse Zellulose, stark saugfähig



		Stück	1	12	24
466 30 00	Coupons: 160, 22.6 x 25 cm	1	18 1 =	49.50 2.75	44.55 2.48
				10 %	20 %
					39.60 2.20

Küchenrolle Starline 3-lagig

100 % reine weisse Zellulose, stark saugfähig



		Stück	1	7	14
466 29 00	Coupons: 60, 22 x 26 cm	1	40 1 =	59.80 1.50	53.82 1.35
				10 %	20 %
					47.84 1.20

Multifunktions-Spender

Der funktionelle Spender für Küchen-Rollen und Papier-Handtücher. Durch die verstellbare Aufhängung passen die meisten Rollen in den Spender, mit Schloss



		Stück	1	
466 31 00	30 x 19.5 cm, H: 25.1 cm	1	1	38.70

Küche

Claseq Spülmaschinen

Die CLASEQ Spülmaschinen zeichnen sich durch ihre einfache und robuste Bauweise aus. Oben und unten angeordnete Spül- und Nachspülarme sorgen für saubere Gläser, Teller, Tassen und Besteck.

- Ablaufpumpe • Eingebautes Reiniger- und Klarspülerdosiergerät
- Selbsterklärende Bedienblende mit zwei Schaltern (Ein-/Aus, Start Spülgang)
- Thermostat, herausnehmbare Korbführungsschienen

Gläserspülmaschine Hydro 400

CH Norm - Breite 450 mm

für Gläserkörbe 400 x 400 mm

Lieferung inklusive:

- 1 Offener Universalkorb
- 1 Gläserkorb
- 1 Besteckeinsatz
- 1 Tellereinsatz

432 80 45	Hydro 400, B x T: 450 x 515 mm, H: 740-760 mm, 230 V, 2.92 kW	 Stück	1	1	3300.00	1
------------------	--	---	---	---	---------	---



Gläserspülmaschine Hydro 750

CH Norm - Breite 550 mm

für Gläserkörbe 500 x 500 mm

Lieferung inklusive:

- 1 Offener Universalkorb
- 1 Tellerkorb
- 1 Besteckeinsatz

432 80 55	Hydro 750, B x T: 550 x 602 mm, H: 825-845 mm, 230V/400 V, 3.44/6.84 kW	 Stück	1	1	3870.00	1
------------------	---	---	---	---	---------	---



Gläserspülmaschinen UC-S/UC-M

Glas ist nicht gleich Glas: Das dünnwandige Weinglas muss ganz anders behandelt werden als der Bierkrug. Deshalb werden bei den neuen Gläserspülmaschinen die für den Spülprozess verantwortlichen Faktoren über drei vordefinierte Programme automatisch der jeweiligen Gläserart angepasst.

Lieferung inklusive:

- | | |
|-------------------------|-------------------------|
| UC-S | UC-M |
| • 1 Bistro-Kombikorb | • Tellerkorb Kunststoff |
| • 1 Gläserkorb 4 Reihen | • 1 Gläserkorb 5 Reihen |
| | • 1 Besteckköcher |

432 18 05	UC-S, B x T: 460 x 617 mm, H: 715 mm, 400 V, 68 kg	 Stück	1	1	5800.00 5220.00	10 %
432 18 10	UC-M, B x T: 600 x 617 mm, H: 715 mm, 400 V, 74	 Stück	1	1	6820.00 6138.00	



winterhalter

Geschirrspülmaschinen UC-L/UC-XL

Ob leichte oder starke Verschmutzung, ob Stärke, Fett oder Eiweiss - das Ergebnis ist ein stets hygienisch sauberes und trockenes Spülgut.

Lieferung inklusive:

- | | |
|----------------------------------|---|
| UC-L | UC-M |
| • 1 Geschirrspülkorb feinmaschig | • Tellerkorb Kunststoff |
| • 1 Tellerkorb Kunststoff | • 1 Bleck/Tablettkorb Edelstahl, 6 Reihen |
| • 1 Besteckköcher 7 Fächer | • 1 Besteckköcher 7 Fächer |

432 19 05	UC-L, B x T: 600 x 617 mm, H: 810 mm, 400 V, 79 kg	 Stück	1	1	7250.00 6525.00	10 %
432 19 10	UC-XL, B x T: 600 x 656 mm, H: 810 mm, 400 V, 79 kg	 Stück	1	1	8320.00 7488.00	



winterhalter

TOP

Systemgastronomie



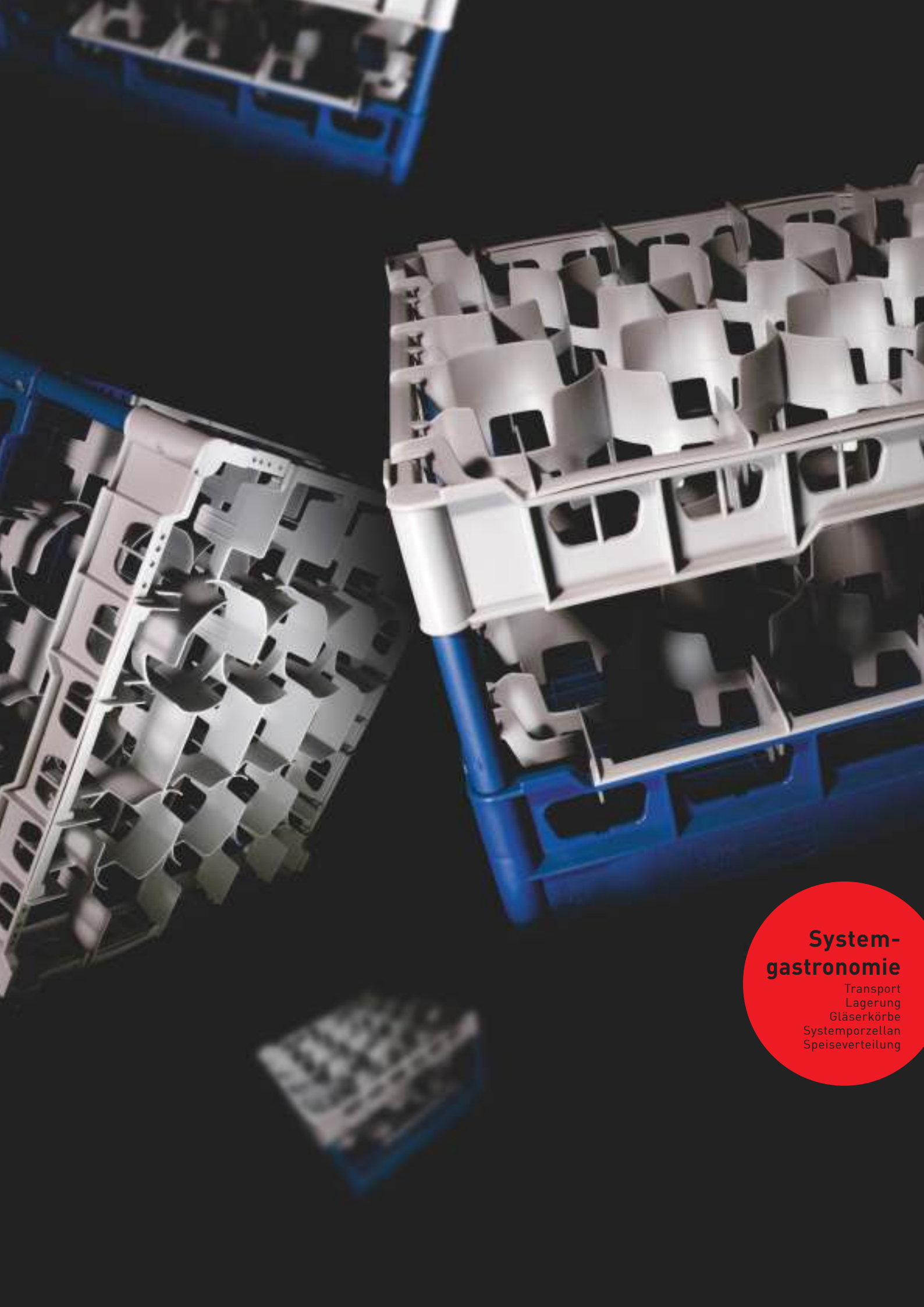

System- gastronomie

Transport
Lagerung
Gläserkörbe
Systemporzellan
Speiseverteilung



Servierwagen CNS

Bis 120 kg, Lenkrollen stahlverzinkt 12.5 cm Ø, 2 mit Feststeller, Höhe des obersten Tablars: 85 cm

		Stück		1
421 42 01	2 Ablare, Zwischenraum: 58.5 cm, 90 x 60 cm, H: 95 cm	1	1	428.00 299.60 30 %
421 42 02	2 Ablare, Zwischenraum: 58.5 cm, 100 x 65 cm, H: 95 cm	1	1	610.00 427.00
421 43 01	3 Ablare, Zwischenraum: 27.5 cm, 90 x 60 cm, H: 95 cm	1	1	530.00 371.00
421 43 02	3 Ablare, Zwischenraum: 27.5 cm, 100 x 65 cm, H: 95 cm	1	1	720.00 504.00



Servierwagen CNS Selv

Bis 100 kg, Lenkrollen 10 cm Ø, 2 mit Feststeller, Höhe des obersten Tablars: 81 cm. leichte Ausführung, einfache Selbstmontage

		Stück		1
421 45 01	3 Ablare, Zwischenraum: 27 cm, 86 x 54 cm, H: 94 cm	1	1	320.00 256.00 20 %



hulu Servicestation CNS

Bis 80 kg, mit 3 geschlossenen Seiten, ausziehbarem Besteckfach mit 6 hulu-Boxen, Lenkrollen 12.5 cm Ø, 2 Stopprollen

		Stück		1
280 55 00	90 x 60 cm, H: 90 cm	1	1	2220.00 1554.00 30 %
280 60 00	Mit Türen, 90 x 60 cm, H: 90 cm	1	1	2550.00 1785.00
280 50 50	Abräum-Besteckbox CNS, GN 1/3, H: 20 cm	1	1	79.00
280 50 51	Abfallbehälter CNS, 42 x 22 cm, H: 25 cm	1	1	290.00



hulu Servicestation CNS

Ohne ausziehbares Besteckfach

		Stück		1
280 50 00	90 x 60 cm, H: 95 cm	1	1	1590.00 1431.00 10 %
280 50 50	Abräum-Besteckbox CNS, GN 1/3, H: 20 cm	1	1	79.00
280 50 51	Abfallbehälter CNS, 42 x 22 cm, H: 25 cm	1	1	290.00



Regalwagen GN 2/1 mit Arbeitsplatte

Mit Transport-Sicherung, 6 Einschübe mit Anschlag für je 2 x 1/1 GN-Bleche und -Tablets, Etagenabstand: 11 cm, 4 Lenkrollen Selbstmontage

		Stück		1
421 59 21	GN: 2/1, H: 102.5 cm, 59.5 x 67 cm, Schienen: 6	1	1	760.00 380.00 50 %

Systemgastronomie

Servierwagen CNS mit Flügeltüren

Mit 3 geschlossenen Seiten und frontseitigen Flügeltüren, belastbar bis 120 kg, 4 Lenkrollen 12.5 cm Ø, 2 mit Feststeller

Verkleidung: Feinblech, doppelseitig elektrolytisch verzinkt, pulverbeschichtet in verschiedene Farben

		Stück		1 20 %
421 44 50	Grannygrün, 3 Tablare, Zwischenraum: 27.5 cm, 90 x 60 cm, H: 95 cm	1	1050.00	840.00
421 44 51	Limette, 3 Tablare, Zwischenraum: 27.5 cm, 90 x 60 cm, H: 95 cm	1	1050.00	840.00

Andere Modelle auf Anfrage



BLANCO



Servierwagen CNS mit Flügeltüren CNS

Mit 3 geschlossenen Seiten und frontseitigen Flügeltüren, belastbar bis 120 kg, 4 Lenkrollen 12.5 cm Ø, 2 mit Feststeller

Verkleidung: CNS

		Stück		1 20 %
421 44 90	CNS, 3 Tablare, Zwischenraum: 27.5 cm, 90 x 60 cm, H: 95 cm	1	1220.00	976.00

Andere Modelle auf Anfrage



BLANCO

Bankett- und Servicewagen

Edelstahlgestell in schwarz, Einlegeböden und Seitenwände in elegantem Anthrazit, die Einlegeböden sind höhenverstellbar

- 4 Lenkrollen, 2 mit Feststeller

- belastbar bis 200 kg

- Gewicht 76 kg

		Stück		1 20 %
250 20 98	111 x 63 cm, 3 Tablare, Zwischenraum: 24 cm, H: 130 cm	1	1890.00	1512.00



Regalwagen mit Arbeitsplatte

Rostfreier Edelstahl, mit Transport-Sicherung, für GN-Bleche und -Tablets, Zwischenabstand: 8.1 cm

		Stück		1 30 %
421 56 11	GN: 1/1, H: 76 cm, 65.3 x 45.4 cm, Schienen: 6	1	756.00	529.20
421 56 21	GN: 2/1, H: 76 cm, 77.3 x 65.9 cm, Schienen: 6	1	918.00	642.60
421 58 11	GN: 1/1, H: 90 cm, 65.3 x 45.4 cm, Schienen: 8	1	886.00	620.20
421 58 21	GN: 2/1, H: 90 cm, 77.3 x 65.9 cm, Schienen: 8	1	970.00	679.00



340.-



Regalwagen CNS GN 1/1

Mit 15 Doppelauflegeschieben zum Transport von bis zu 30 GN-Tabletts GN1/2 oder 15 GN-Bleche bis GN 1/1, mit Transportsicherung. Abstand: 7.5 cm, 4 Lenkrollen 12.5 cm Ø, 4 Feststeller
Selbstmontage

		Stück		1
421 53 11	GN: 1/1, H: 177 cm, 55 x 38.5 cm	1	1	425.00 340.00 20 %



Regalwagen

Aus rostfreiem Edelstahl, 20 Schienen, für GN-Bleche und -Tabletts, Abstand: 7.7 cm. 4 Lenkrollen 12.5 cm Ø, 2 mit Feststeller

		Stück		1
421 57 11	GN: 1/1, H: 178.5 cm, 65.3 x 45.4 cm	1	1	907.00 634.90 30 %
421 57 21	GN: 2/1, H: 178.5 cm, 77.3 x 65.9 cm	1	1	994.00 695.80 30 %



Tablett-Abräumwagen

Tablett-Abräumwagen aus rostfreiem Edelstahl mit 2 Seitenwänden aus melaminharzbeschichteten Platten in beige, mit 4 Lenkrollen 12.5 cm Ø, 2 mit Feststellern, schonende Tablettauflage dank Abrundung, passend für 3 Tablettgrößen:

- Euronorm 53 x 37 cm
- GN 1/1 53 x 32.5 cm
- Kantinen-Norm 46 x 34.4 cm
- Abstand der Auflagen: 12.2 cm

		Stück		1
280 67 12	H: 178.5 cm, 51 x 63 cm	1	1	1220.00 854.00 30 %
280 67 24	H: 178.5 cm, 93.5 x 63 cm	1	1	1685.00 1179.50 30 %

Systemgastronomie

Servicestation wetterfest

- Wetterfest in Wenge-Dekor
 Stabiles und pulverbeschichtetes Edelstahlgestell
 - 1 Besteckschublade
 - 1 Flügeltüre
 - 1 Flachboden
 - 4 Lenkrollen, 2 mit Feststeller

		Stück		
250 19 85	112 x 53.5 cm, H: 107 cm	1	1	4600.00 4140.00 10 %



Harassen Transportwagen CNS

Total 8 Harassen (40 x 30 cm) oder 12 Kleinharassen (30 x 20 cm)

- 4 Gitterböden à 100 x 36 cm
 - Abstand zwischen den Gitterböden: 34.5 cm
 - 4 Lenkrollen 12.5 cm Ø, 2 Feststeller
 - Selbstmontage

Tragkraft: ca. 120 kg

		Stück		
500 22 00	108 x 57 cm, H: 161 cm	1	1	875.00 755.00



Tellerwagen

Für 200 Teller mit einstellbaren Trennungen, Tellergrösse bis 29 cm Ø, Höhe der Tellerauflage beträgt 46 cm, mit 4 Lenkrollen 12.5 cm Ø, 2 Lenkrollen mit Feststellern

		Stück		
500 38 09	Teller Ø 29 cm, 106.5 x 45 cm, H: 100 cm	1	1	875.00 700.00 20 %



Tablett-Abräumwagen BLANCO Professional

Tablett-Abräumwagen aus rostfreiem Edelstahl mit 2 Seitenwänden aus Feinblech, doppelseitig elektrolytisch verzinkt, pulverbeschichtet in verschiedenen Farben erhältlich, komplett abnehmbar für die einfache Reinigung

- GN 1/1 53 x 32.5 cm
 - Abstand der Auflagen: 12.5 cm
 - Ausstattung mit 4 Lenkrollen 12.5 cm Ø, 2 davon mit Feststellern
 - Serienmässig mit Wandabweisern zum Schutz vom Tablettwagen und Mobiliar
 - Tragfähigkeit insgesamt max. 150 kg

Es sind weitere Modelle und Farben verfügbar, kontaktieren Sie uns, wir beraten Sie gerne

		Stück		
280 68 51	H: 155 cm, 46.8 x 67.3 cm, Limette	1	1	1320.00 1056.00
280 69 51	H: 155 cm, 85 x 67.3 cm, Limette	1	1	1680.00 1344.00



BLANCO



ab
25.20



Geschirrspülkorb Cambro

Polypropen, robust, hitze-, spül- und chemikalien-beständig, stapelbar

			Stück		1
442 58 45	rot, 50 x 50 cm, grobmaschig	1	1	50.40	25.20
442 58 91	grau, 50 x 50 cm, grobmaschig	1	1	50.40	25.20
442 57 91	grau, 50 x 50 cm, feinmaschig	1	1	54.20	27.10

TOP



Universal-Tellerkorb Cambro

Für flache und tiefe Teller

Polypropen, robust, hitze-, spül- und chemikalien-beständig, stapelbar

			Stück		1
442 59 91	grau, 500 x 500 mm	1	1	54.20	27.10



Universal-Tellerkorb

Für flache und tiefe Teller sowie für Tablett

			Stück		1
441 05 00	500 x 500 mm	1	1		56.00



Besteckkorb

8 Fächer, für 250 - 300 Bestecke

Polypropen, robust, spülbeständig, stapelbar

			Stück		1
441 03 00*	430 x 208 mm	1	1		29.00

Systemgastronomie

Gläserkörbe

Robuster Gläserkorb für das Waschen und Aufbewahren von Gläsern. Dank Unterteilungen bis 30% weniger Bruch. Grundfarbe grau, Basiskorb in div. Farben lieferbar

Gläserkörbe Cambro, 16 Unterteilungen

500 x 500 mm, Facheinteilung 109 x 109 mm

		Stück		1
				50 %
442 70 91	Glashöhe mit Stiel: 90 mm	1	1	77.00 38.50
442 71 91	Glashöhe mit Stiel: 132 mm	1	1	101.00 50.50
442 72 91	Glashöhe mit Stiel: 174 mm	1	1	121.00 60.50
442 73 91	Glashöhe mit Stiel: 216 mm	1	1	147.00 73.50
442 74 91	Glashöhe mit Stiel: 258 mm	1	1	169.00 84.50
442 75 91	Glashöhe mit Stiel: 300 mm	1	1	197.00 98.50



Gläserkorb Cambro, 25 Unterteilungen

500 x 500 mm, Facheinteilung 87 x 87 mm

		Stück		1
				50 %
442 82 91	Glashöhe mit Stiel: 90 mm	1	1	77.00 38.50
442 83 91	Glashöhe mit Stiel: 132 mm	1	1	103.00 51.50
442 84 91	Glashöhe mit Stiel: 174 mm	1	1	123.00 61.50
442 85 91	Glashöhe mit Stiel: 216 mm	1	1	147.00 73.50
442 86 91	Glashöhe mit Stiel: 258 mm	1	1	169.00 84.50
442 87 91	Glashöhe mit Stiel: 300 mm	1	1	197.00 98.50



Gläserkorb Cambro, 36 Unterteilungen

500 x 500 mm, Facheinteilung 72 x 72 mm

		Stück		1
				50 %
442 94 91	Glashöhe mit Stiel: 90 mm	1	1	91.00 45.50
442 95 91	Glashöhe mit Stiel: 132 mm	1	1	104.00 52.00
442 96 91	Glashöhe mit Stiel: 174 mm	1	1	125.00 62.50
442 97 91	Glashöhe mit Stiel: 216 mm	1	1	149.00 74.50
442 98 91	Glashöhe mit Stiel: 258 mm	1	1	174.00 87.00
442 99 91	Glashöhe mit Stiel: 300 mm	1	1	197.00 98.50



Staubschutz-Deckel

ABS, schützt das in den Körben gelagerte Geschirr

		Stück		1
				40 %
441 19 00	50 x 50 cm	1	1	75.00 45.00



Gläserkorb zu Gabriel Glas, 20 Unterteilungen

500 x 500 mm, Facheinteilung 99 x 99 mm

		Stück		1
443 35 23	Gläserkorb grau	1	1	84.00



Transportrolli für Geschirrkörbe

4 Lenkrollen 12.5 cm Ø, 2 Lenkrollen mit Feststellern

		Stück		1
				20 %
442 50 50	Mit wegnehmbarer Kunststoffwanne ABS, 57 x 57 cm, H: 22.5 cm	1	1	400.00 320.00
442 50 51	Mit Kunststoffwanne ABS und CNS Stosgriff, 63 x 57 cm, H: 90 cm	1	1	535.00 428.00





39,20

Gläserkorb Flex, 16 Unterteilungen, 500 x 500 mm

Zur einmaligen Fixierung auf die passende Höhe zwischen 120 bis 240 mm

Facheinteilung 113 x 113 mm

	Stück		1
443 20 16* Glashöhe mit Stiel: bis 240 mm	1	1	49.00 39.20 20 %

Gläserkorb Flex, 500 x 500 mm

Geschirrkorb für Espresso Ober- und Untertassen



	Stück		1
443 24 17* für 17 Tassen und Untertassen	1	1	49.00 39.20 20 %
443 23 28* für 28 Tassen und Untertassen	1	1	49.00 39.20 20 %



Staubschutzdeckel/Abtropfwanne

Schützt das in den Körben gelagerte Geschirr und dient auch als Abtropfwanne

	Stück		1
443 25 00*	1	1	36.00 28.80 20 %



Transportrolli für Geschirrkörbe

4 Lenkrollen, davon 2 Lenkrollen mit Feststellern

	Stück		1
443 26 00* 55 x 55 cm	1	1	158.00 126.40 20 %



Gläserkörbe Fries, 9 Unterteilungen, 400 x 400 mm

Facheinteilung 115 x 115 mm

	Stück		1
443 30 22 Glashöhe mit Stiel: 216 mm	1	1	73.00
443 30 23 Glashöhe mit Stiel: 228 mm	1	1	73.00
443 30 24 Glashöhe mit Stiel: 240 mm	1	1	82.00



Gläserkörbe Fries, 16 Unterteilungen, 400 x 400 mm

Facheinteilung 88 x 88 mm

	Stück		1
443 31 15 Glashöhe mit Stiel: 144 mm	1	1	62.00
443 31 17 Glashöhe mit Stiel: 168 mm	1	1	62.00
443 31 18 Glashöhe mit Stiel: 180 mm	1	1	62.00
443 31 19 Glashöhe mit Stiel: 192 mm	1	1	73.00
443 31 20 Glashöhe mit Stiel: 204 mm	1	1	73.00
443 31 21 Glashöhe mit Stiel: 216 mm	1	1	73.00
443 31 22 Glashöhe mit Stiel: 228 mm	1	1	73.00
443 31 24 Glashöhe mit Stiel: 240 mm	1	1	82.00
443 31 25 Glashöhe mit Stiel: 252 mm	1	1	82.00



Gläserkörbe Fries, 25 Unterteilungen, 400 x 400 mm

Facheinteilung 68 x 68 mm

	Stück		1
443 32 16 Glashöhe mit Stiel: 156 mm	1	1	62.00
443 32 17 Glashöhe mit Stiel: 168 mm	1	1	62.00
443 32 18 Glashöhe mit Stiel: 180 mm	1	1	62.00
443 32 22 Glashöhe mit Stiel: 216 mm	1	1	73.00
443 32 23 Glashöhe mit Stiel: 228 mm	1	1	73.00

Systemgastronomie



Gläserkörbe Fries

Bewährt in der Gastronomie, mit vielen Optionsmöglichkeiten. Die Körbe sind nicht standardisiert und werden auf den Glas-Typ zusammengestellt. Pro Korb soll die Differenz der Glashöhe 2 cm nicht übersteigen.
Grundfarbe: blau

Gläserkörbe Fries, 16 Unterteilungen gelb

500 x 500 mm, Facheinteilung 113 x 113 mm

		Stück	
443 40 24	Glashöhe mit Stiel: 180 - 240 mm	1	84.00
443 40 28	Glashöhe mit Stiel: 230 - 280 mm	1	110.00



Gläserkörbe Fries, 20 Unterteilungen grau

500 x 500 mm, Facheinteilung 99 mm Ø

		Stück	
443 41 24	Glashöhe mit Stiel: 180 - 240 mm	1	84.00
443 41 28	Glashöhe mit Stiel: 230 - 280 mm	1	110.00



Gläserkörbe Fries, 25 Unterteilungen blau

500 x 500 mm, Facheinteilung 90 x 90 mm

		Stück	
443 42 13	Becher H: 70 - 130 mm	1	71.00
443 42 24	Glashöhe mit Stiel: 180 - 240 mm	1	84.00
443 42 28	Glashöhe mit Stiel: 230 - 280 mm	1	110.00



Gläserkörbe Fries, 36 Unterteilungen grün

500 x 500 mm, Facheinteilung 74 x 74 mm

		Stück	
443 43 13	Becher H: 70 - 130 mm	1	71.00
443 43 24	Glashöhe mit Stiel: 180 - 240 mm	1	84.00
443 43 28	Glashöhe mit Stiel: 230 - 280 mm	1	110.00



Gläserkörbe Fries, 44 Unterteilungen hellblau

500 x 500 mm, Facheinteilung 67 mm Ø

		Stück	
443 44 24	Glashöhe mit Stiel: 180 - 240 mm	1	84.00
443 44 28	Glashöhe mit Stiel: 230 - 280 mm	1	110.00



ab
22.-



Gläser-, Lager- und Transportkorb

Behälter ohne Unterteilung

Ideal für Catering, Mehrzweckhallen und überall dort, wo Gläser gelagert und transportiert werden. Die flexible Unterteilung ermöglicht das Anpassen auf jedes Glas, stapelbar, mit Traggriffen

		Stück		1
500 32 17	Glashöhe mit Stiel: 92 - 148 mm, 60 x 40 cm, H: 17 cm	1	1	22.00
500 32 22	Glashöhe mit Stiel: 137 - 197 mm, 60 x 40 cm, H: 22 cm	1	1	25.00
500 32 27	Glashöhe mit Stiel: 193 - 246 mm, 60 x 40 cm, H: 27 cm	1	1	27.00
500 32 32	Glashöhe mit Stiel: 241 - 299 mm, 60 x 40 cm, H: 32 cm	1	1	29.00
500 34 50	Deckel	1	1	18.00

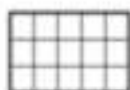

bis 15 Gläser
jusqu'à 15 verres,
bis jusqu'à 108 mm H

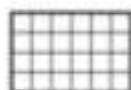

bis 24 Gläser
jusqu'à 24 verres,
bis jusqu'à 95 mm H

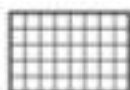

bis 40 Gläser
jusqu'à 40 verres,
bis jusqu'à 65 mm H

Unterteilungen

Stabile Unterteilung, inkl. Bodenführung

		Stück		1
500 33 15	Teilung: 15, 10.9 x 11.7 cm	1	1	37.00
500 33 24	Teilung: 24, 8.6 x 9 cm	1	1	40.00
500 33 40	Teilung: 40, 6.7 x 6.7 cm	1	1	46.00



Stapel-Behälter grau

		Stück	1	12	30	
500 00 12	H: 12 cm, 60 x 40 cm, 20 l	1	1	27.10	24.39 10 %	23.04 15 %
500 00 22	H: 22 cm, 60 x 40 cm, 40 l	1	1	34.90	31.41 14.94	29.67 13.28
500 00 32	H: 32 cm, 60 x 40 cm, 60 l	1	1	44.60	40.14 12.56	37.91 11.17
500 01 00	Deckel, 60 x 40 cm	1	1	13.10	11.79	11.14



Harassenbeutel

Starke Qualität, transparent

		Stück	1	10	25	
500 10 58	Gelocht, Grösse: 60/40 x 58 cm	1	500 100 =	83.00 16.60	74.70 14.94 10 %	66.40 13.28 20 %
500 10 75	Ungelocht, Grösse: 60/40 x 75 cm	1	500 100 =	69.80 13.96	62.82 12.56	55.84 11.17

89.60



Harassenroller Roll-Boy

Aus stabilem ABS für Stapel-Behälter, Kisten, Harassen etc., bis 60 x 40cm, Tragkraft bis 200 kg

		Stück		1
500 25 00	60 x 40 cm	1	1	412.00 89.60 20 %



Rollbehälter

Praktischer Rollbehälter, überall einsetzbar, z.B. auch für Leergut, aus Kunststoff, stapelbar, Tragfähigkeit bis 200 kg

		Stück		1
500 28 00	180 l, 80 x 60 cm, H: 64.5 cm	1	1	212.00
500 28 01	Ohne Rollen, 180 l, 80 x 60 cm, H: 50 cm	1	1	133.00

Systemgastronomie

Vorratstonnen

Niederdruck Polyethylen, speziell für die Lagerung von Lebensmitteln

		Stück		
500 15 40	40 l, H: 44.5 cm, 42 cm Ø	1	1	65.00
500 15 50	50 l, H: 54.5 cm, 42 cm Ø	1	1	79.00
500 16 00	Deckel, 42 cm Ø	1	1	15.00



Vorrats- und Abfalltonnen (Tränkekessel)

Tonne mit Deckel, für die Lagerung von Lebensmitteln geeignet

		Stück		
500 20 50	50 l, H: 46 cm, 40 cm Ø	1	1	61.00 51.85
500 21 00	Ausziehrolli für Rundbehälter	1	1	105.00



Vorratswagen

Für Mehl, Zucker etc. fahrbar, 4 Lenkrollen 7.6 cm Ø, nach vorne abgeschrägt

		Stück		
421 40 10	Für 68 - 103 kg, 102 l, H: 71 cm, 42 x 75 cm	1	1	729.00 583.20
421 40 14	Für 102 - 143 kg, 140 l, H: 71 cm, 55 x 75 cm	1	1	770.40 616.32



Transportwagen

Rahmen aus T-Eisen, Stossstange aus Stahlrohr, glanzverzinkt, Bodenplatte aus Novopan, 2 Lenkrollen und 2 Bockrollen mit Vollgummipneus, 12.5 cm Ø

		Stück		
500 27 00*	90 x 60 cm, H: 95 cm	1	1	395.00 316.00



Transportwagen CNS

Stabile Ausführung mit 2 Lenkrollen und 2 Bockrollen, Tragfähigkeit bis 200 kg

Transportfläche: 56 x 94 cm

		Stück		
500 23 00	105 x 56 cm, H: 92.5 cm	1	1	269.00



Getränke- und Sackkarren

Stahlrohr-Konstruktion, verzinkt, Nylon-Gleitkufen für Treppen, Lufträder mit Walzenlagerung, Spezialschaufel passend für Getränkeharassen

		Stück		
500 26 00*	51 x 41 cm, H: 148 cm	1	1	498.00 398.40



Dinner Max

MONDO-Linie

Speisen wie im Restaurant! MONDO ist ein hochwertiges Transport- und Isoliersystem mit Porzellangeschirr für die Lieferung eines kompletten 2 - 5 Gang Menüs ausser Haus. Die Speisen bleiben während mindestens 2 Stunden heiss: garantiert über 65 °C - Sommer wie Winter. Sämtliche Deckel der Geschirrtteile sind aus Silikon und garantieren eine leichte Handhabung, sind auch beim Transport 100% dicht, farbstabil und hitzebeständig bis 200 °C.



Set komplett für 4-Gänge Dinner Max

- 1 x Isolierbox Ober- und Unterteil
- 1 x Porzellangeschirr 3-teilig mit gelbem Deckel
- 1 x Salat-/ Dessertschale 200 ml
- 2 x Suppen-/ Beilagenschale 300 ml
- Je 1 x Deckel rot und gelb und 1 x Kühldeckel blau

Isolierbox: 400 x 295 x 115 mm

	Stück	1	20
461 00 01	1 1	277.00	263.15



Menümarkierung

Austauschbare Plättchen in verschiedenen Farben dienen als Inhaltskennzeichnung der Box (auch beschriftbar)

	Stück	1	60
461 01 00 weiss	1 1	1.70	1.62



Isolierbox Ober- und Unterteil Dinner Max

	Stück	1	20
461 00 00 silbergrau, 400 x 295 x 115 mm	1 1	115.00	109.25



Porzellangeschirr Dinner Max

	Stück	1	60
461 02 07 Teller 3-teilig, oval, 780 ml	1 1	43.00	40.85
461 02 08 Teller 2-teilig, oval, 800 ml	1 1	35.00	33.25
461 02 10 Teller ohne Unterteilung, oval, 1000 ml	1 1	38.00	36.10
461 06 20 Salat-/ Dessertschale, 200 ml	1 1	16.00	15.20
461 06 30 Salat-/ Suppenschale, 300 ml	1 1	17.00	16.15
461 06 36 Suppen-/ Beilagenschale, 360 ml	1 1	19.00	18.05



Deckel Silikon für Teller oval/Schalen rund

	Stück	1	60
461 03 15 Deckel gelb für Teller oval	1 1	23.00	21.85
461 07 15 Deckel gelb für Schale rund	1 1	10.00	9.50

Systemgastronomie

Transportbehälter Blancotherm, unbeheizt

GN-Transportbehältern aus doppelwandigem Polypropylen (PUR-geschäumt) erleichtern Sie den Speisetransport. Alle Modelle sind platzsparend übereinander stapelbar und leicht zu reinigen.

BLANCO



		Stück		1
460 65 00	GN: 1/1, 200 mm, Toploader, 630 x 425 mm, H: 340 mm, 7,5 kg	1	1	670.00 502.50 25 %

Transportbehälter Blancotherm, unbeheizt

GN-Transportbehältern aus doppelwandigem Polypropylen (PUR-geschäumt) erleichtern den Speisetransport. Alle Modelle sind platzsparend übereinander stapelbar und leicht zu reinigen.

BLANCO



ab
645.-

		Stück		1
460 65 11	GN: 2 x 1/1, 150mm, Frontlader, Schienen: 11, 630 x 430 mm, H: 490 mm, 10 kg	1	1	860.00 645.00 25 %
460 65 12	GN: 3 x 1/1, 150 mm, Frontlader, Schienen: 12, 630 x 425 mm, H: 660 mm, 13.5 kg	1	1	990.00 742.50

Transportbehälter Blancotherm, beheizt

Ohne Temperaturregler
GN-Transportbehältern aus doppelwandigem Polypropylen (PUR-geschäumt) erleichtern Sie den Speisetransport. Alle Modelle sind platzsparend übereinander stapelbar und leicht zu reinigen.

BLANCO



		Stück		1
460 66 11	GN: 2 x 1/1, 150 mm, Frontlader, Schienen: 11, 700 x 445 mm, H: 475 mm, 230 V, 200 W, 16 kg	1	1	1390.00 1042.50 25 %
460 66 12	GN: 3 x 1/1, 150 mm, Frontlader, Schienen: 12, 700 x 445 mm, H: 660 mm, 230 V, 200 W, 19.5 kg	1	1	1690.00 1267.50

Transportbehälter Blancotherm, beheizt

Mit Temperaturregler
Die integrierte Temperaturregelung von +40° bis +85°C und die LED-Anzeige sorgen für eine optimale Kontrolle der Temperatur im Innern.
GN-Transportbehältern aus doppelwandigem Polypropylen (PUR-geschäumt) erleichtern Sie den Speisetransport. Alle Modelle sind platzsparend übereinander stapelbar und leicht zu reinigen.

BLANCO



25%

		Stück		1
460 67 11	GN: 2 x 1/1, 150 mm, Frontlader, Schienen: 11, 700 x 445 mm, H: 475 mm, 230 V, 200 W, 16 kg	1	1	1590.00 1192.50 25 %
460 67 12	GN: 3 x 1/1, 150 mm, Frontlader, Schienen: 12, 700 x 445 mm, H: 660 mm, 230 V, 200 W, 19.5 kg	1	1	1970.00 1477.50

Getränke-Spender Camtainer

Für perfekte Mobilität, optimal isoliert, hält Getränke stundenlang kalt oder warm, stapelbar, mit 2 Traggriffen, Aussparung zum Unterstellen von breitrandigen Trinkgefässen, Zapfhahn



		Stück		1
260 40 09	10.4 l, 42.5 x 30 cm, H: 50 cm, 7.7 kg	1	1	504.00 403.20 20 %
260 40 18	20 l, 42.5 x 30 cm, H: 68 cm, 9.5 kg	1	1	567.00 453.60

AM LAUFENDEN BAND.



Cook & Chill und Cook & Serve

Sinnvolle Lösungen für Ihre Speisenverteilung beim Zwischenlagern, Portionieren, Transportieren und Ausgeben.



System Kompetenz von Seltmann Weiden



SYSTEM



MADE IN GERMANY

Wir produzieren in Deutschland



NEW



Vitalis - Seltmann Weiden Porzellan

Vitalis –einfach leichter geniessen. Egal - ob jung, nicht mehr ganz so jung, jung geblieben –oder mit Handicap. Die Porzellan-Serie Vitalis hilft die kulinarischen "Ausflüge" uneingeschränkt zu geniessen. Speziell geformte, tief ausgerundete Teller Spiegel ermöglichen ein leichtes Aufnehmen der Speisen auf Gabel und Löffel. Die Untertassen sind tiefer gemuldet, damit die Obertassen und Becher selbst in einem extremen Neigungswinkel absolut rutschsicher im Spiegel der Untertasse stehen. Vital ist vielseitig einsetzbar und fast überall zu Hause - in Kindertagesstätten, Pflegeheimen, der Autobahngastronomie, Kantinen, der Schulverpflegung und in der Klinikgastronomie. (%) Mengenrabatte innerhalb der Marke Seltmann, auch gemischt

Teller flach Vitalis



		Stück	1	60	120
				10 %	20 %
114 911 11	Teller flach, 20 cm Ø	6 1	9.60	8.64	7.68
114 913 55	Teller flach, 23 cm Ø	6 1	11.70	10.53	9.36
114 916 87	Teller flach, 25.5 cm Ø	6 1	12.80	11.52	10.24
114 920 09	Teller flach, 28 cm Ø	6 1	20.30	18.27	16.24

Teller tief Vitalis



		Stück	1	60	120
				10 %	20 %
114 921 75	Teller tief, 20 cm Ø	6 1	10.40	9.36	8.32
114 923 41	Teller tief, 23 cm Ø	6 1	12.80	11.52	10.24

Teller halbtief Vitalis



		Stück	1	60	120
				10 %	20 %
114 940 89	Teller halbtief, 25.5 cm Ø	6 1	14.70	13.23	11.76

Systemgastronomie

Systemteller rund 3-teilig Vitalis

	Stück	1	60	120
			10 %	20 %
114 960 63 Systemteller 3-teilig, 25,5 cm Ø	2	1	25.00	22.50 20.00



Platten oval Vitalis

	Stück	1	60	120
			10 %	20 %
114 943 33 Platte oval, 31 cm Ø	2	1	26.30	23.67 21.04
114 944 99 Platte oval, 35 cm Ø	2	1	29.70	26.73 23.76



Suppentasse und Untertasse Vitalis

	Stück	1	60	120
			10 %	20 %
114 929 95 Suppentasse, 0,35 l	6	1	11.90	10.71 9.52
114 926 63 Suppen-Untertasse, 17,5 cm Ø	6	1	6.80	6.12 5.44



Suppenschale mit Griff Vitalis

	Stück	1	60	120
			10 %	20 %
114 959 75 Suppenschale mit Griff, 0,5 l	6	1	13.30	11.97 10.64



Schalen Vitalis

	Stück	1	60	120
			10 %	20 %
114 935 61 Schale nieder, 16 cm Ø, 0,35 l, H: 4,1 cm	4	1	9.70	8.73 7.76
114 932 39 Schale hoch, 16 cm Ø, 0,55 l, H: 6 cm	4	1	10.30	9.27 8.24



Dessertschale Vitalis

	Stück	1	60	120
			10 %	20 %
114 938 25 Dessertschale, 12 cm Ø, 0,22 l, H: 4,2 cm	4	1	7.30	6.57 5.84



Tasse und Untertasse Vitalis

	Stück	1	60	120
			10 %	20 %
114 949 29 Kaffee-Obertasse, 0,18 l	6	1	8.10	7.29 6.48
114 945 87 Kaffee-Untertasse, 15,5 cm Ø	6	1	5.40	4.86 4.32



Mugs mit Henkel Vitalis

	Stück	1	60	120
			10 %	20 %
114 953 49 Mug mit Henkel, 0,25 l	6	1	8.70	7.83 6.96
114 951 05 Mug mit Henkel, 0,3 l	6	1	8.80	7.92 7.04
114 955 25 Mug mit 2 Henkel, 0,3 l	6	1	9.20	8.28 7.36



Vitalis ist in verschiedenen Farben und Dekoren erhältlich. Oder wie wäre es mit Ihrem Logo des Hauses?

Wir beraten Sie gerne.



Salatschale eckig Varionorm

	Stück	1	60	120
114 295 07 Salatschale eckig, 12 x 12 cm, 0.3 l, H: 4.3 cm	4	1	13.60	12.24 10.88
				10 % 20 %



Systemteller rund Varionorm

	Stück	1	60	120
115 969 21 Systemteller 3-teilig, 25.5 cm Ø	2	1	32.60	29.34 26.08
115 968 15 Systemteller 2-teilig, 25.5 cm Ø	2	1	31.20	28.08 24.96
				10 % 20 %



Suppenschalen mit Griff Varionorm

	Stück	1	60	120
115 948 06 Suppenschale mit Griff, 0.4 l	6	1	14.20	12.78 11.36
115 949 37 Suppenschale mit Griff, 0.45 l	4	1	16.50	14.85 13.20
				10 % 20 %



Portionskrug Varionorm

	Stück	1	60	120
115 973 65 Portionskrug, 0.35 l	2	1	28.00	25.20 22.40
110 018 96 Deckel, grau-transparent	1	1	8.90	8.01 7.12
				10 % 20 %



Isolierkannen Helios Brilliant Edelstahl

Die Vollmetallkanne ist spülmaschinenfest und unzerbrechlich. Das Klappdeckelsystem garantiert eine einfache Einhandbedienung. 3 Jahre Garantie für Warmhaltung

	Stück	1	60	120
260 39 06 0.6 l, 11.2 cm Ø, H: 16 cm	1	1	79.00	63.20 20 %
260 39 10 1 l, 12.7 cm Ø, H: 19 cm	1	1	86.00	68.80 20 %
260 39 15 1.5 l, 14 cm Ø, H: 22 cm	1	1	93.00	74.40 20 %

ab
48,80



Isolierkannen Helios Wave S+

Spülmaschinenfest bis 95°C, unzerbrechlicher Isoliereinsatz aus rostfreiem, doppelwandigem Edelstahl für eine lange Warmhaltung der Getränke, 3 Jahre Garantie

	Stück	1	30	60
260 33 10 1 l, H: 25.2 cm, 16.5 cm Ø, weiss	1	1	61.00	54.90 48.80
260 34 10 1 l, H: 25.2 cm, 16.5 cm Ø, schwarz	1	1	61.00	54.90 48.80
				10 % 20 %

NEW



Isolierkanne Hepp mit Scharnierdeckel

Spülmaschinenfest, doppelwandig isoliert und stapelbar. CNS 18/10, poliert. Das Scharnierdeckelsystem garantiert eine einfache Einhandbedienung.

	Stück	1	30	60
260 91 03 0.3 l, 9.1 cm Ø, H: 10.3 cm	1	1		69.00



Isolierkanne Mepra mit Scharnierdeckel

Spülmaschinenfest und doppelwandig isoliert in polierter Ausführung, CNS 18/10. Das Scharnierdeckelsystem garantiert eine einfache Einhandbedienung.

	Stück	1	30	60
260 92 03 0.3 l, 9.5 cm Ø, H: 9.5 cm	1	1		166.00

Systemgastronomie

Top Dining Systemporzellan - Seltmann Weiden Porzellan

Attraktiver Speisenpräsentation mit TOP DINING - Flexibel und funktional einsetzbar und bringt mit eckigen und dreieckigen Artikeln einen neuen Look in die Speisenverteilung. Umfassendes Know-how wurde in Porzellan umgesetzt, das einzigartig ist. (%) Mengenrabatte innerhalb der Marke Figgjo, auch gemischt

NEW

Teller flach 3-eckig Top Dining

	Stück	1	60	120
			10 %	20 %
114 075 43 Teller flach 3-eckig, 23.8 cm Ø	6	1	15.90	14.31
110 018 81 Deckel, grau-transparent	1	1	36.00	32.40
				28.80



Teller flach 4-eckig Top Dining

	Stück	1	60	120
			10 %	20 %
114 076 86 Teller flach 4-eckig, 24 x 24 cm	6	1	15.90	14.31
110 018 82 Deckel, grau-transparent	1	1	37.30	33.57
				29.84



Teller 4-eckig, 2-teilig Top Dining

	Stück	1	60	120
			10 %	20 %
114 092 59 Teller 2-teilig, 24 x 24 cm	6	1	18.30	16.47
110 018 82 Deckel, grau-transparent	1	1	37.30	33.57
				29.84



Teller flach Top Dining

	Stück	1	60	120
			10 %	20 %
114 078 29 Teller flach, 23 cm Ø	6	1	14.20	12.78
110 019 01 Deckel, grau-transparent	1	1	38.30	34.47
				30.64



Dessertschale 3-eckig Top Dining

	Stück	1	60	120
			10 %	20 %
110 230 75 Dessertschale, 13 cm, 0.37 l, H: 5 cm	2	1	13.30	11.97
110 019 45 Deckel, grau-transparent	1	1	17.30	15.57
				13.84



Dessertschale 4-eckig Top Dining

	Stück	1	60	120
			10 %	20 %
114 079 72 Dessertschale, 15 x 15 cm, 0.35 l	6	1	15.90	14.31
110 019 45 Deckel, grau-transparent	1	1	17.30	15.57
				13.84



Portionskrug Top Dining

	Stück	1	60	120
			10 %	20 %
114 081 15 Portionskrug, 0.31 l	2	1	28.00	25.20
110 018 96 Deckel, grau-transparent	1	1	8.90	8.01
				7.12



Suppenschale Top Dining

	Stück	1	60	120
			10 %	20 %
114 082 58 Suppenschale, 13.6 cm Ø, 0.53 l	6	1	14.40	12.96
110 018 84 Deckel, grau-transparent	1	1	17.80	16.02
				14.24



Eintopfschale Top Dining

	Stück	1	60	120
			10 %	20 %
114 170 63 Eintopfschale, 19.4 cm Ø, 1.1 l	4	1	26.20	23.58
110 018 95 Deckel, grau-transparent	1	1	29.40	26.46
				23.52



Hotel

ALISEO

NUMATIC
HOTELS & RESORTS

caddie.

premier *Star*

EDAK

Rieffel
HOTELS & RESORTS

Heute
HOTELS & RESORTS

SPA COLLECTION

hulu

Valera+
HOSPITALITY



Hotel

Hotellkosmetik
Zimmer
Etage
Reception
Garderobe



1 ab
0,28



Dusch-/Badegel

30 ml

	Stück	1	12
840 01 00	1 500	173.00	138.40
	1 =	0.35	0.28
			20 %

Haar-Shampoo

30 ml

	Stück	1	12
840 01 01	1 500	173.00	138.40
	1 =	0.35	0.28
			20 %

Body-Lotion

30 ml

	Stück	1	12
840 01 02	1 500	173.00	138.40
	1 =	0.35	0.28
			20 %



Hair-Conditioner

30 ml

	Stück	1	12
840 01 04	1 500	173.00	138.40
	1 =	0.35	0.28
			20 %



Seife im Portionbeutel

12 g

	Stück	1	12
840 01 50	1 1000	189.00	151.20
	1 =	0.19	0.15
			20 %



Shampoo-/Duschgel

Portionen-Beutel, 10 ml

	Stück	1	12
840 01 51	1 1000	120.00	96.00
	1 =	0.12	0.10
			20 %

1 ab
0,10



Seife

In Präsentierbox, 15 g

	Stück	1	12
840 01 10	1 1000	290.00	232.00
	1 =	0.29	0.23
			20 %



Duschhaube

In Präsentierbox

	Stück	1	12
840 01 44	1 50	18.00	14.40
	1 =	0.36	0.29
			20 %



Vanity-Kit

In Präsentierbox

	Stück	1	12
840 01 45	1 50	18.00	14.40
	1 =	0.36	0.29
			20 %



Zahnpflege-Set

In Präsentierbox

	Stück	1	12
840 01 13	1 50	59.00	47.20
	1 =	1.18	0.94
			20 %



Rasier-Set

In Präsentierbox

	Stück	1	12
840 01 14	1 50	45.00	36.00
	1 =	0.90	0.72
			20 %



Nagelfeile

In Präsentierbox

	Stück	1	12
840 01 46	1 100	26.00	20.80
	1 =	0.26	0.21
			20 %

Hotel



Schuhlöffel

	Stück	1	12
840 01 41	1	100	35.00
	1=		0.35
			28.00
			0.28



Gäste-Nähset In Präsentierbox

	Stück	1	12
840 01 47	1	50	18.00
	1=		0.36
			14.40
			0.29



Kamm

	Stück	1	12
840 01 42	1	100	36.00
	1=		0.36
			28.80
			0.29



Duschhaube im Beutel

	Stück	1	12
840 01 48	1	250	45.00
	1=		0.18
			36.00
			0.14



Schuhpflegeset In Präsentierbox

	Stück	1	12
840 01 49	1	50	18.00
	1=		0.36
			14.40
			0.29



Slippers weiss, offen

	Stück	1	12
840 01 39	1	100	180.00
	1=		1.80
			144.00
			1.44



Pumpdispenser Seife 310 ml

	Stück	1	12
840 01 25	1	30	147.00
	1=		4.90
			117.60
			3.92



Pumpdispenser Bodylotion 310 ml

	Stück	1	12
840 01 26	1	30	147.00
	1=		4.90
			117.60
			3.92



Pumpdispenser Duschgel/Shampoo 310 ml

	Stück	1	12
840 01 27	1	30	147.00
	1=		4.90
			117.60
			3.92



Präsentier-Bord schwarz für 3 Flacons und 1 Box

	Stück	1	12
840 01 18	1	10	54.00
	1=		5.40
			43.20
			4.32



Präsentier-Bord schwarz für 4 Boxen

	Stück	1	12
840 01 19	1	10	54.00
	1=		5.40
			43.20
			4.32



Präsentier-Bord schwarz für 2 Flacons und 2 Boxen

	Stück	1	12
840 01 20	1	10	54.00
	1=		5.40
			43.20
			4.32



Small-Tablett CHIC

Das Small-Tablett CHIC ist komplett mit braunem Kunstleder eingefasst und zeichnet sich durch seinen vielseitigen Verwendungszweck aus!

	Stück	1	12
281 88 85	1	1	22.00
			17.60

20 x 10 cm, H: 2 cm





Gäste Accessoires

		Stück			
840 00 10*	Gästeseifchen, 4.3 x 3 cm	1	600 100 =		1 76.50 12.75
840 21 10*	Dusch-/Badegel Portionenbeutel, 10 ml	1	700 100 =		1 88.20 12.60



Schutzbeutel und Zahnputzglas

		Stück			
830 22 00	Schutzbeutel, 13 x 20 cm	1	1000		1 29.50
140 93 00	Zahnputzglas, 220 ml, H: 8.9 cm, 7.3 cm Ø	6	1	1.30	1 72 10 % 144 20 % 1.04



Kosmetiktücher

Zellstoffwatte, Box à 100 Stück

		Stück			
840 60 20	Box uni, weiss	1	4000 100 =	57.00 1.38	14 10 % 28 20 % 45.60 1.10



Gesichtstuchspender CHIC

Kunstleder braun, 25 x 13.5 cm, H: 6.5 cm, (ohne Inhalt)

		Stück			
840 66 85	braun	1	1	36.00	12 10 % 30 20 % 28.80



Gesichtstuchspender

		Stück			
840 64 00	Kunststoff weiss	1	1	16.30	20 5 % 14.67 10 %
840 63 00	Kunststoff verchromt	1	1	24.30	20 23.09 21.87



Kosmetiktücher Square

Samtweiche Kosmetiktücher für hohe Ansprüche.

100% Zellstoff, weiss, 3-lagig

Karton enthält 30 Boxen, (Box à 60 Kosmetiktücher)

		Stück			
840 59 00	12 x 11.5, H: 12 cm	1	30	69.00	20 10 % 62.10 20 % 55.20
840 67 85	Gesichtstuchspender braun	1	1	45.00	12 10 % 30 20 % 36.00

Spender Smart

Eleganter und platzsparender Dosierspender! Für tropfsichere und einfach zu wechselnde Einwegpatronen. Unzerbrechlich, aus Polycarbonat.
Optimal geeignet für Hotelzimmer, Lavabos, Dusche, Bad, Toiletten etc. Unzerbrechlich, aus Polycarbonat.

		Stück		1	12	24
611 86 00	Spender weiss, 8.7 x 6.5 cm, H: 16.5 cm	12	1	49.50	15.60	20 %
611 86 90	Spender silber, 8.7 x 6.5 cm, H: 16.5 cm	12	1	49.50	15.60	



Patronen Smart

3 Produkte in einem: Seife - Shampoo - Duschgel. Spitzenqualität, aus pflanzlichen Grundstoffen, ph-neutral, dermatologisch geprüft, angenehm parfümiert, biologisch abbaubar.

		Stück		1	12	24
611 87 30	300 ml	1	12	79.00	71.10	63.20
			1 =	6.58	5.92	5.26



Alphamouss Spender

Das elegante Gel-System für Hotelzimmer, Lavabos, Dusche, Bad etc. Unzerbrechlich, aus Polycarbonat, Pumpe wartungs- und abnützungsfrei, tropfsicher.

		Stück		1	12	24
830 30 00	Spender, 16.2 cm Ø, T: 7.2 cm	1	1	29.90	19.44	35 %
830 30 50	Ersatzschlüssel	1	1			3.50



Alphamouss Patronen

3 Produkte in einem: Seife - Shampoo - Duschgel. Aus pflanzlichen Grundstoffen, biologisch abbaubar, Spitzenqualität, ph-neutral, dermatologisch geprüft, angenehm parfümiert.

		Stück		1	12	24
830 31 00	350 ml	1	24	179.80	170.81	161.82
			1 =	7.49	7.12	6.74
830 32 00	350 ml	1	1			7.90



Seifenspender Alphamouss XL

Das elegante System mit 2 l Inhalt für Sporthallen und Fitnesscenter, Pumpe wartungs- und abnützungsfrei

		Stück		1	8	12
611 80 00	Spender XL, 17.6 x 9.9 cm, H: 36.2 cm	1	1			69.90
611 82 20	Seife extra mild, 2000 ml	1	6			89.80
			1 =			14.97
611 83 20	Duschgel und Shampoo, 2000 ml	1	6			109.70
			1 =			18.28



Duschgel + Shampoo

Das praktische Duschgel und Shampoo zum Auffüllen. Aus pflanzlichen Grundstoffen biologisch abbaubar, Spitzenqualität, ph-neutral, dermatologisch geprüft, angenehm parfümiert

		Stück		1	8	12
830 10 05	Bidon à 5 l	1	1	37.80	34.02	30.24



Valera Haartrockner

VALERA Haartrockner werden in der Schweiz produziert und zeichnen sich durch Spitzenleistung in Technologie, Zuverlässigkeit, Sicherheit und Design aus – sie sind 'Swiss Made'. Das Schweizer Image zeugt von Qualität, Genauigkeit, Vertrauen, Kompetenz, Respekt für Umwelt und Gesundheit und Exklusivität.



ab
36,80

Haartrockner Executive 1200 Super

Haartrockner zur einfachen Wandmontage

- Schiebetaste:
 - 2 Temperatur/Luftstrom-Schaltkombinationen
 - Ein / Aus Druckschalter
 - Ondulierdüse
 - Wandhalter:
 - Ein / Aus Sicherheitsschalter
- vRG CHF 0.60

		Stück	1	25	50
830 43 00	230 V, 1200 W	1	46.00	41.40	36.80
				10 %	20 %



ab
44.-

Haartrockner Premium 1600

Haartrockner zur einfachen Wandmontage

- Ein / Aus Druckschalter
 - 1 Temperatur- / Lüfterstufe
 - Ondulierdüse
 - Wandhalter
 - Ein / Aus Sicherheitsschalter
- vRG CHF 0.60

		Stück	1	25	50
830 08 00	230 V, 1600 W	6	55.00	49.50	44.00
				10 %	20 %



Haartrockner Action Super Plus 1800

Haartrockner zur einfachen Wandmontage

- Schiebetaste:
 - 2 Lüfterstufen
 - 3 Temperaturstufen
 - Abkühlstufe COOL
 - Ein / Aus Druckschalter
 - Wandhalter:
 - Ein / Aus Sicherheitsschalter
- vRG CHF 0.60

		Stück	1	25	50
830 42 00	White, 230 V, 1800 W	1	78.00	70.20	62.40
830 42 99	Black, 230 V, 1800 W	1	78.00	70.20	62.40
				10 %	20 %



ab
36,80

Haartrockner Action 1600 Push

- Ein- / Aus-Druckschalter
 - Schiebetaste:
 - 2 Lüfterstufen
 - 3 Temperaturstufen
 - Abkühlstufe COOL
 - Spiralkabel mit Stecker (ohne Montage)
- vRG CHF 0.60

		Stück	1	25	50
830 44 00	230 V, 1600 W	1	46.00	41.40	36.80
				10 %	20 %



Wandhalterung für Haartrockner

verchromt

		Stück	1	25	50
830 40 50	Universal	1	13.80	12.42	11.04
830 40 51	Jolly, ringförmig, mit Kabelsperrvorrichtung	1	11.90	10.71	9.52
				10 %	20 %

Haartrockner Action Super Plus 1600 Shaver

Haartrockner zur einfachen Wandmontage

- Schiebetaste:
 - 2 Lüfterstufen
 - 3 Temperaturstufen
 - Abkühlstufe COOL
 - Ein- / Aus-Druckschalter
 - Gumminoppen zur Rutschsicherung
 - Ondulierdüse
 - vRG CHF 0.60
- Wandhalter
 - Ein- / Aus-Sicherheitsschalter
 - Rasiersteckdose 110-120V und 220-240V
 - Sicherheits-Trenntransformator
 - Komfort-Nachtlicht



SWISS MADE



		Stück	1	25	50
830 41 00	230 V, 1600 W	1	1	104.00	93.60
					83.20
					10 %
					20 %

Haartrockner Viper

Haartrockner mit diebstahlsicherer Wandhalterung, Hauptschalter mit Kontrollleuchte, mit 3 Heizstufen, eingebauter Überhitzungsschutz, Sicherheitstaste

		Stück	1	25	50
830 05 00*	230 V, 1400 W	1	1	75.00	52.50
					30 %

30%



Kosmetik-Spiegel Ligth One

mit LED-Beleuchtung

An Wandhalterung montierter beleuchteter Spiegel

- LED-Beleuchtung 100-240 V, 50-60 Hz
 - Ein/Aus-Schalter
 - Schwenkarm: Länge 180 mm
 - Material: Messing
 - Spiegel: Ø 216 mm
 - Schutzgrad: IP 44
- 3-fache Vergrößerung
 - Komplettschwenkbar
 - Oberfläche: Chrom
 - Fest verdrahtet

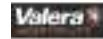

SWISS MADE

		Stück	1	25	50
830 39 00	LED-Beleuchtung	1	1	210.00	189.00
					168.00
					10 %
					20 %

Kosmetik-Standspiegel Silvana

Metall verchromt, mit schwenkbarem Vergrößerungs-Spiegel (5-fach), 17 cm Ø, H: 49 cm

		Stück	1	24	48
830 06 00	H: 49 cm	12	1	42.00	37.80
					33.60
					10 %
					20 %

Kosmetik-Standspiegel Felisa

Metall verchromt, mit schwenkbarem Vergrößerungs-Spiegel (3-fach)
Sockel 20.5 x 15 cm, H: 34.5 cm

		Stück	1	24	48
830 07 00	H: 34.5 cm	6	1	53.00	47.70
					42.40
					10 %
					20 %





Gesichtstuchspender CHIC

Kunstleder braun (ohne Inhalt)

		Stück	1	12	30
840 66 85	braun, 25 x 13.5 cm, H: 6.5 cm	1	1	36.00	32.40
					28.80



Gesichtstuchspender Square

Kunstleder braun (ohne Inhalt)

		Stück	1	12	30
840 67 85	braun, 14 x 14 cm, H: 15 cm	1	1	45.00	40.50
					36.00



Papierkorb CHIC

Kunstleder braun, innen Edelstahl

		Stück	1	12	30
800 50 85	braun, 25 cm Ø, H: 28 cm	1	1	49.00	44.10
					39.20

Papierkorb Conical

Kunstleder schwarz, innen Edelstahl

		Stück	1	12	30
800 51 99	schwarz, 24 x 24 cm, H: 31 cm	1	1	79.00	71.10
					63.20



Tee-Box CHIC

Tee-Box in Kunstleder Kroko-Optik braun, mit 6 Teebeutelächer, (ohne Inhalt)

		Stück	1	12	30
260 67 86	Kroko braun, H: 6.5 cm, 24 x 18.5 cm	1	1	62.00	49.60



Servierblech CHIC

Servierblech in Kunstleder Kroko-Optik

		Stück	1	12	30
281 86 99	Kroko schwarz, 41 x 26 cm	1	1	69.50	55.60



Wasserkocher Turmix

Kabelloser Wasserkocher mit Kochstop-Automatik und Überhitzungsschutz, Inhalt 1.0 Liter, Klappdeckel mit Sicherheitsverriegelung

		Stück	1	12	30
450 38 10	B x T: 21 x 12 cm, H: 22 cm, 230 V, 1800 W, 0.7 kg	1	1	49.00	44.10

Room-Box CHIC

für Tee/Kaffee, Kunstleder in Kroko-Optik braun, ohne Tassen und Löffel

		Stück	1	12	30
811 03 86	Kroko braun, 36 x 28 cm, H: 8.5 cm	1	1	96.00	86.40
					86.40 78.40



premiStar

Kofferständer CHIC

aus Holz, klappbar

		Stück	1	12	30
800 19 00	60 x 55 x 45 cm	1	1	98.00	88.20
					88.20 78.40



premiStar

ab
78.40

Kofferständer easy

Stabile Ausführung, verchromt, kippbar, mit Trägerrücken

		Stück	1	12	30
800 18 00	60 x 40 cm, H: 48 cm	1	1	59.80	53.82
					53.82 47.84



premiStar

Room-Serve

Das Wärmeglockensystem eine herausragende Warmhalteleistung, insbesondere im Zimmerservice.

Der Artikel aus Unterteller und Glocke besteht aus 100% lebensmittelechtem, doppelwandigem Material mit isolierender Zwischenschicht. Beide Teile sind spülmaschinenfest und perfekt stapelbar. Die Oberfläche ist kratz- und stoßfest.

Aussenmasse: 32.5 cm Ø / H: 10 cm

Innenmasse: 29.5 Ø cm / H: 6 cm

Für Teller bis 29 cm Ø

		Stück	1	12	30
135 96 29	Wärmeglocken-Set	1	1	42.00	42.00 29.40





Säcke für Schmutzwäsche

Plastik weiss, mit Zugband und blauem, 4-sprachigem Aufdruck

		Stück	1	6	12
820 15 00	35 x 57 cm	1	100 1 =	25.50	22.95
				0.26	0.23
		Stück	1	3	6
820 16 00	35 x 57 cm	1	500	127.50	114.75
				10.20	10.20

ab
23,92



Abfallboy Hit

Edelstahl poliert, mit herausnehmbarem Kunststoffeinsatz

		Stück	1	12	30
610 55 03	3 l, H: 25 cm, 17 cm Ø	1	1	29.90	26.91
				23.92	
610 55 05	5 l, H: 29 cm, 20 cm Ø	1	1	39.90	35.91
				31.92	
		Stück	1	10	30
610 50 50	Einlagebeutel, 19 x 19 cm, H: 38 cm	1	100	11.90	11.31
				10.71	



Abfallboy Lux

Edelstahl poliert, mit herausnehmbarem Kunststoffeinsatz

		Stück	1	12	30
610 56 03	3 l, H: 25 cm, 17 cm Ø	1	1	35.50	33.73
				31.95	
610 56 05	5 l, H: 29 cm, 20 cm Ø	1	1	44.50	42.28
				40.05	
		Stück	1	10	30
610 50 50	Einlagebeutel, 19 x 19 cm, H: 38 cm	1	100	11.90	11.31
				10.71	



Toiletten-Abfallboy

Kunststoff weiss, mit herausnehmbarem Einsatz

		Stück	1	12	30
610 80 05	24.6 x 21 cm, H: 27.7 cm, 5 l	1	1	22.00	20.90
				19.80	
		Stück	1	10	30
610 50 50	Einlagebeutel, 19 x 19 cm, H: 38 cm	1	100	11.90	11.31
				10.71	



Papierkörbe

Kunststoff

		Stück	1	12	30
800 35 93	Granit, 25.5 cm Ø, H: 24 cm	1	1	5.90	5.31
				4.72	
800 37 00	Weiss, 22 cm Ø, H: 25 cm	1	1	13.50	12.15
				10.80	
800 38 00	Weiss, 25.5 x 18 cm, H: 25 cm	1	1	13.20	11.88
				10.56	



Papierkörbe Matt steel

Abnehmbarer Deckel zum Fixieren der Kehrichtsäcke.

		Stück	1	4	8
800 39 05	5 l, 21.6 cm Ø, H: 23.8 cm	1	1	33.00	31.35
				29.70	
800 39 11	11 l, 26.2 cm Ø, H: 30.9 cm	1	1	39.00	37.05
				35.10	



Tür-Anhängeschilder "Nicht stören"

Mit international verständlichem Piktogramm

Rot: Besetzt, nicht stören

Blau: Frei, Zimmer aufräumen

		Stück	1	3	6
800 20 00	19.2 x 9.6 cm	1	50 1 =	35.00	31.50
				28.00	

Kunststoff Kleiderbügel

	Stück	1	60	120
			10 %	20 %
800 13 99 46 cm	1	1	1.24	1.12 0.99



Form-Kleiderbügel aus Holz

Aus Holz, Farbe natur, mit Kerbe

	Stück	1	60	120
			10 %	20 %
740 23 01 44.5 cm	5	1	2.40	2.16 1.92



ab
1.92

Form-Kleiderbügel aus Holz

Aus Holz, Farbe kirsch, mit Kerbe und rutschfestem Steg

	Stück	1	60	120
			10 %	20 %
740 23 88 44.5 cm	5	1	3.20	2.88 2.56



Kleiderbügel CNS

	Stück	1	40	80
			10 %	20 %
740 22 00 43 cm	4	1	4.20	3.78 3.36



Diebstahlsichere Kleiderbügel

Ohne Diebstahlsicherungsring

	Stück	1	60	120
			10 %	20 %
740 28 00 Kleiderbügel Holz, naturlackiert, 44 cm	1	1	2.90	2.61 2.32



Diebstahlsicherungsringe

Für die Kleiderstange

	Stück	1	60	120
			10 %	20 %
740 28 50 Diebstahlsicherungsring Metall	1	1	0.70	0.63 0.56
800 03 98 Diebstahlsicherungsring Plastik, braun	1	1	0.40	0.36 0.32



Garderobenständer CNS

Rohr Ø 3.8 cm, 4 Lenkräder 10 cm Ø, 2 mit Feststeller, zur Selbstmontage

	Stück	1	480.00	336.00
				30 %
740 13 00 120 x 53 cm, H: 170 cm	1	1		





Garderoben

Stahlrohrrahmen, seidenmatt lackiert, basaltgrau, Hut-/Mantelhaken, Schirmhalter und Becken aus Aluminium
Auch in anderen Längen und Farben lieferbar

		Stück		1
740 12 24	Garderobenständer rund, 24 Haken	1	1	1220.00
740 10 46	46 Haken, 156 cm	1	1	1354.00
740 10 58	58 Haken, 196 cm	1	1	1472.00
740 11 46	46 Haken, 156 cm, Fahrbar	1	1	1500.00
740 11 58	58 Haken, 196 cm, Fahrbar	1	1	1618.00



Standascher/Abfallbehälter/Schirmständer

		Stück		1
740 09 72	Standascher CNS, H: 72 cm, 30 cm Ø	1	1	189.00 151.20 20 %
740 14 50	Schirmständer CNS, H: 50 cm, 21 cm Ø	1	1	62.00 49.60



Securit Line

Elegante Ausführung mit dekorativer Kordel, Pfosten verchromt

		Stück		1
340 80 00	Pfosten verchromt, H: 100 cm	1	1	99.00 69.30 30 %
340 81 15	Absperrtau dunkelrot, 150 cm	1	1	28.00 19.60
340 81 16	Absperrtau rot, geflochten, 150 cm	1	1	57.00 42.00
340 81 99	Absperrtau schwarz, geflochten, 150 cm	1	1	57.00 42.00
340 80 50	Wandhaken verchromt	1	1	12.00

Weiteres Zubehör auf Anfrage



hulu Absperrsystem CNS

Das preisgünstige Personenleit- und Absperrsystem überzeugt weltweit - ob in Hotels, Flughäfen, Banken etc. Stabiler Absperrpfosten mit 2.1 m Rollband. Die Gurtkassette ermöglicht das Anbringen in vier verschiedene Richtungen. Pfosten und Abdeckplatte des Fusses aus Chromnickelstahl
Pfostenhöhe: 98 cm, Fuss: 32.5 cm Ø

		Stück		1
350 20 00	Absperr-System CNS	1	1	165.00 115.50 30 %
350 20 52	Wandhalterung zum Einhängen des Gurtenbandes	1	1	3.90



Rezeptions- und Küchenglocke

		Stück		1
800 70 05	mit schwarzem Metallfuss, Ø 8.5 cm	1	1	12.00 8.40 30 %
800 70 00*	mit Holzfuss, Ø 9 cm	1	1	19.00 13.30

Schlüsselanhänger

Für schnelle, individuelle Selbstbeschriftung

		Stück	1	25	50
800 25 00	12 cm	1	1	9.30	8.84
					5 %
800 26 00	S-Haken	1	5		
					1.40



Schlüsselanhänger Alu

Aus Leichtmetall, matt eloxiert, mit Gummiring und Aufhängehaken

		Stück	1	25	50
800 22 00	12 cm, 70 g	1	1	13.00	12.35
					5 %
800 24 01	Gravurkosten 1-stellig	1	1		6.60
800 24 02	Gravurkosten 2-stellig	1	1		7.50
800 24 03	Gravurkosten 3-stellig	1	1		8.20



Schlüsselkasten VT-SK

Stahlblech, Zylinderschloss mit 2 Schlüsseln, Haken fest, inkl. Schlüsselketten

		Stück	1	25	50
800 42 02	20 Haken, 16 x 8 cm, H: 20 cm	1	1		40.00
800 42 05	48 Haken, 24 x 8 cm, H: 30 cm	1	1		65.00

Schlüsselkasten VT-SK 8000

Stahlblech, gebördelt, Zylinderschloss mit 2 Schlüsseln, Haken fest, nummeriert, inkl. Schlüsselketten

		Stück	1	25	50
800 43 03	30 Haken, 21.5 x 5.5 cm, H: 45 cm	1	1		70.00
800 43 10	100 Haken, 38 x 8 cm, H: 55 cm	1	1		147.00
800 43 15	150 Haken, 38 x 6.5 cm, H: 55 cm	1	1		189.00



Staubsauger HENRY plus

Profi-Trockensauger

Das Gerät ist mit einem effizienten und langlebigen Hochleistungsmotor ausgestattet, manuelle Umschaltung von 420 auf 620 Watt möglich, Energieeffizienzklasse A, Kabelaufroll- und Schnellwechselsystem, leichte und platzsparende Aufbewahrung des Saugrohrs und der Bodendüse, Ausstattung mit Parkfunktion, enthalten: Zubehörset mit Saugrohren und trittfestem FloMax Saugschlauch, HiPro Kombidüse, Trockensaugdüse mit Bürste und umfangreichem Kleinteile-Zubehör.

		Stück	1	25	50
602 81 45	Rot, 35.5 x 35.5 cm, H: 41.5 cm, Kabellänge 12.5 m, 9 l	1	1		295.00
602 81 65	Blau, 35.5 x 35.5 cm, H: 41.5 cm, Kabellänge 12.5 m, 9 l	1	1		295.00
602 81 50	Hepa-Floh Vliesstaubebeutel zu HENRY plus	1	10		25.50



Wäschewagen klappbar

CNS, klappbar, 4 Lenkrollen

		Stück	1	25	50
850 29 00	60 x 61 cm, H: 100 cm	1	1	370.00	259.00
					30 %
850 29 50	Ersatzwäschesack 280 l	1	1		46.00





336.-



Gepäckwagen

Teppichbodenbelag grauCNS 18/8 und 18/10Rohr 2.4 cm ØRad 20 cm Økomplett geschweisst und montiert

		Stück		1
850 02 00	H: 120 cm, 74 x 60 cm, 14 kg	1	1	420.00 336.00 20 %

Gepäck- und Transportwagen

Teppichbodenbelag grauCNS 18/8 und 18/10 Rohr 5 cm Ø4 Lenkrollen 20 cm Ø, 2 mit Feststellerumlaufende Gummischutzleiste
Zur Selbstmontage!

		Stück		1
850 03 00	110 x 62 cm, H: 190 cm, 40 kg	1	1	990.00 792.00 20 %



985.-

Caddykit I

Der Hotelwagen SKT2 zeichnet sich durch sein stabiles Grundgestell aus. Die Halterungen, aus pulverbeschichtetem Stahl, ermöglichen die Befestigung von zwei 100 Liter Wäschesäcken. Diese können mittels einfaches Klick-System schnell gewechselt werden. Der extra grosse Stauraum ermöglicht die Mitnahme von grossem Frischwäschevolumen

- 6 x Laufräder 100 mm Ø
- 2 x 100 Liter Wäschesäcke
- 2 x Ablageschalen mit Deckel

		Stück		1
850 40 00	151 x 58 cm, H: 141 cm	1	1	1035.00



Wäschebeutel

		Stück	1	12	24
620 28 00	weiss, 35 x 25 cm, H: 125 cm	1	250	71.90	64.71 57.52 20 %

Andere Farben ab 24 Ct. sortiert möglich



Wäschewagen klappbar

Komplett aus stabilen pulverbeschichteten Metallrohren, 4 Lenkrollen

1 x 200 Liter Wäschesack

		Stück		1
850 45 00	76 x 46 cm, H: 96 cm	1	1	314.00

Wäschewagen klappbar

Komplett aus stabilen pulverbeschichteten Metallrohren, 4 Lenkrollen

2 x 100 Liter Wäschesack

		Stück		1
850 46 00	76 x 46 cm, H: 96 cm	1	1	314.00

Inhalt A - Z

A		
Abfallboy	43	
Abfalleimer	46, 59, 319, 442	
Abfallkorb	46	
Abfalltonnen	421	
Abrechnungstaschen	336	
Absperrsystem	442	
Abwasch-Bürsten	54	
Abwasch-Pad/-Schwamm	43	
Abziehstahl	355	
Adesectin	53	
Airlaid Servietten	10, 11	
Allzwecktuch	52	
Alu-Klapprahmen	307	
Aluminiumfolie	405	
Amuse Bouche	246-250, 314	
Anschlagrahmen	307	
Apéro-Gläser	208, 210, 215	
Apfel- und Birnenteiler	354	
Apotheker	359	
Aschenbecher	318, 319	
Ascherpinsel	318	
Aufhängeschiene	56	
Aufschnitt-Maschine	380	
Ausbeinmesser	355	
Ausstecher	397, 398	
Ausstellplatten	402	
B		
Backbleche	387, 395, 396	
Backemulsion	372	
Backtrennpapier	395	
Badewannen-Bürsten	54	
Bain-Maries	381	
Bambus-Fleischspießli	404	
Bar-Gläser	172, 192, 196 208, 210, 211, 214 215, 217-221	
Bar-Kombination	224	
Barlöffel	223	
Barmesser	358	
Barmixer	227	
Barrailmatte	226	
Barschneidebrett	224, 275	
Bar-Sieb	221	
Batterie-Schere	21	
Becher	208-211, 214 215, 217, 220	
Beilagenbehälter	226	
Beilagen-/Gewürzbox	226	
Besen	56	
Besenhalter	56	
Besenstiele	55	
Besteck	174-181, 183, 184, 186	
Besteckboxen	271	
Besteckkasten	271	
Besteckkörbe	416	
Bierglas-Bürsten	54	
Biergläser	220	
Bistro-Schürzen	336	
Bitterflasche	222, 224	
Blumenvasen	317	
Bodenlappen	57	
Bonbücher	339	
Bormioli Luigi	211	
Bowls	77, 79, 81, 154, 168	
Bowls	245	
Brandschutz-Decken	372	
Bratpfannen	321, 347, 348, 349	
Bratschaufeln	351, 352	
Brennersystem Hot & Safe	254	
Brennpaste	254	
Brennpasten-Brenner	254	
Brigde Buffet	266, 267	
Brosamenschaber	300	
Brotbrett	301	
Brötchen-Beutel	403	
Brötchen-/Sandwich-Box	301	
Brot-/Früchte-Korb	299, 300	
Brot-Körbchen	265, 269, 298, 299 322, 323	
Brotkrümelschaber	300	
Brotmesser	355	
Brot-Präsentierkorb	300	
Brottschneide-Maschine	380	
Buffet-Leiter	268	
Buffet-Schild	302	
Buttertopf	162, 244	
Buttertopf mit Cloche	244	
Buttertopf-Papiere	244	
Buttertopf Piano	162	
C		
Caddykit	444	
Caldor	252	
Caquelons	322, 323, 324	
Casserole-Bürsten	54	
Casserolier-Schürzen	406	
Catering Take away	26-29	
Cerealien-Spender	267	
Chafing Dish	252, 255, 265, 268 270	
Chafing Dish-Besteck	253	
Chafing Dish-Heizung	253, 254	
Champagner-Flaschenverschluss	237	
Champagner-Saver	237	
Champagnerschüssel	236, 237	
Chef-Schürzen	406	
Chef-Torchons	407	
CHIC	297, 433	
China-Löffel	187	
Citro-Feuchtservietten	403	
Clipper-Mop	57	
Cocktail-Gläser	219	
Cocotten	150	
China-Löffel	187	
Citro-Feuchtservietten	403	
Clipper-Mop	57	
Cocktail-Gläser	219	
Cocotten	150	
Cognac-/Grappagläser	192, 196, 221	
Cognac-/Sherrygläser	221	
Cole & Mason	294, 295	
Container-Einlegesäcke	59	
Coupefiguren	173	
Coupegläser	171-173, 219	
Coupe-/Macchiato-Löffel	163, 184	
Coupon-Aufspiesser	338	
Coupons-Becher	293, 338	
Cremier	155, 164	
Crumbler	300	
Cutter	365, 366	
D		
Dariol-Formen	397	
Dashbottle	222, 224	
Datierautomat	391	
Deckel GN-Behälter	259, 382, 383, 385	
Deckel GN-Behälter	387, 388	
Dekanter	203	
Dessertkelch	171-173, 219	
Digestivo	221	
Dinetray	331	
Dinner Max	422	
Dinnertex Servietten	16-17	
Diplomatkapseln	401	
Dispo-Servietten	12	
Dispo-Servietten-Spender	12	
Dosenöffner	356	
Dosiertrichter	400	
Dressiersäcke	399	
Drop Stop	233	
Durchschlag	352	
Duschbad-Portionenbeutel	432, 433	
Duschgel	432, 433, 435	
Dusch-Hauben	432, 433	
E		
Eierbecher	155	
Eierkocher	371	
Eierlöffel	155	
Eierpinsel	397	
Eierplatte	151, 153, 323	
Eierschneider	354	
Eierstückler	354	
Eimer	359	
Eimer-Wagen	58	
Einlagebeutel	43	
Einmachglas	249, 250	
Einschubblech GN	387, 388, 396	
Einsteckschilder	271	
Einweg-Besteck	36	
Einweg-Dressiersäcke	399	
Einweg-Handschuhe	407	
Einweghüllen für Tellerstapler	392	
Einweg-Kochmützen	406	
Einweg-Rührstäbchen	35	
Einweg-Schalen	33, 35	
Einweg-Teller	36	
Einweg-Trinkbecher	26-30, 34-36	

E

Eisen-Bratpfannen	348
Eiswürfel-Behälter	224, 228, 229
Eiswürfelmaschinen	230
Eiswürfel-Zange	229
Eiswürfel-Zerkleinerer	229
Entkalker	376
Etagenwagen	444
Etageren	278

F

Farbstifte	334
Fenster-Reinigungsgerät	53
Feuchtservietten	403
Feuerzeug	313
Figgjo Porzellan	123-139
Filetirmesser	355
Flambi-Spiess	321
Flaschen	205
Flaschen-Ausgiesser	222-225
Flaschen-/Barregal	224
Flaschen-Bürsten	54
Flaschen-Entkorker	233
Flaschenhalter	234
Flaschenkühler	234, 234
Fleischgabel	351
Fleischhaken	358
Fleisch-Klopfer	355
Fleischspieß	150, 152, 404
Fleischspieß Herkules	152, 404
Fleischtopf	342-345
Folien-Abreisshalter	405
Fondue	322, 323, 324
Fondue Bourguignonne	324
Fondue-Gabeln	322, 323
Fondue Rechauds	171, 322, 324
Fondue-Teller	152, 323
Fotokopierpapier	311
Frischhaltefolie	404, 405
Fritteusen	377
Frittier-Öltester	377
Friture-Kellen	351

G

Garderoben	441, 442
Garderobenständer	441, 442
Garnier-Tüllen	399
Garten Tischdecken	36
Gärtner-Schürzen	406
Gas-Brenner	324
Gaskocher	370
Gas Nachfülldose	252
Gas-Rechaud	370
Gästeseifchen	432, 433, 434
Gebäckbeutel	301
Gebäck- und Tortenglocken	300
Gebäck-Zange	401

Gefriersäcke	391
Geldzahl-Kassetten	337
Gemüseschneider	360, 366
Gemüseschneider Spinnrad	360
Gemüse-Seiher	353
Gepäckwagen	444
Geschirrspülbürste	56
Geschirrspülkörbe	416
Gesichtstuchspender	434, 438
Getränkedosierer	225
Getränkekarren	421
Getränke-/Menükarten	308-311
Getränke-Mixer	227
Getränke-Spender	281-283
Gewürzbox	226
Gewürzstreuer	353
Glacebecher	170-173
Glace-Portionierer	371, 401
Gläser-Abtropfmatten	333
Gläserkörbe	417-419
Gläser-, Lager- und Transportkörbe	420
Gläserständer	333
Gläsertücher	54
Glasflaschen	205
Glas-Krüge	206, 207
Glas-Schalen	170
Glas-Schüsseln	166, 168
Glas-Teller	167-170
Glühweinkocher	257, 282, 283
GN-Abtropfplatten	382, 383
GN-Behälter	259, 382, 383, 385, 386-388
GN-Rost CNS	387
GN-Schalen	258, 259, 382, 383, 385, 387, 388
GN-Transportbehälter	382
GN-Vorratsbehälter	257, 382, 383, 385, 387, 388
GN-Zwischensteg	387
Göffel	187, 251
Gourmetplatten	151, 153, 323
Gratin-Platte	145, 147, 323
Green Vac GN-Abtropfplatte	391
Green Vac GN-Behälter	391
Griddleplatte	372
Grill	373
Grillbürste	372
Grillier-Emulsion	372
Grillier-Pinsel	372
Grillpfanne	348
Grill-Pinsel	372
Grill-/Portionenzangen	351, 352
Gummi-Handschuhe	51

H

Haartrockner	436, 437
Hackstock	363
Hackstock-Folie	363
Hahnen-Bürsten	55

Halter für Besteckboxen	271
Halter für Hygienebeutel	44
Halter: Tassenunterlagen	22
Halter: Tellerpapiere	22
Händetrockner	44
Hand-Fegbürsten	56
Handschuhe	407
Handtuchdispenser	48, 49, 51
Handtuchrollen	48
Handtuchspender	44, 407
Handwaschbürsten	51
Handwischer	55, 56
Harassenbeutel	420
Harassenroller	420
Heissgetränke-Spender	282, 283
Heissluftdämpfer	376
Heissluftofen	375
Heisser Stein	148, 149
Hinweisschilder	43, 302, 303
Hochstapler GN 11	276
Hold-o-mat	375
Holzstößel / Limettenpresse	224
Hot Dog-Apparat	372
Hot-Stone	148, 149
Housekeeping-Wagen	444
Hygienebeutel	44
Hygienebeutel-Dispenser	44

I

Ice Crusher	229
Induktions-Kochstellen	370
Isolier-Becher	34
Isolierkannen	285
Isolierkrüge	285, 428

J

Jasskarten	339
Jumbo WC-Rollen	42

K

Kaffeefilter	399
Kaffeegläser	162, 163
Kaffeekrüge	284, 285
Kaffee-Löffel	163, 183, 184
Kaffeemaschine	282
Kaffeetassen	35, 71, 73, 77, 79, 83, 86, 87, 89, 91, 123, 126, 129, 130, 157-159
Kaffeetassen-Halter	35
Kandiergitter	398
Kannen-Handschutz	20, 24, 284
Karaffen	202, 205
Karaffen-Halter	203
Kartenhalter	292, 301, 303, 331, 332
Kartoffelausstecher	350, 358

Inhalt A - Z

K

Kartonbecher	35
Käse-Menage	293
Käsemesser	358
Käseplatte	263, 264, 266, 267 270, 277
Käseschaufel	358
Käsestreuer	293
Kassablock-Deckel	338
Kassablocks	338
Kassa-/Service-Laufbonblock	338
Kasserole	342, 343, 345
Katrin System	48-49
Kehrgarnitur	55
Kehrriechtschaufeln	55
Keksform	396
Kellner-Geldtasche	311, 337
Kellner-Messer	233
Kerzen	312, 317
Kerzenmanchetten	312
Kerzotron-Kartusche	316
Kinderbett	334
Kindersitz	334
Kinder-Spielzeuge	334, 335
Kinderstuhl	334
Kinder-Teller	151, 335
Kirschgläser	218, 221
Klarsichtfolie	404, 405
Kleiderbügel	441
Knoblauch- und Zwiebelpresse	354
Kochlöffel	352
Kochmesser	355, 357
Koch-Messerkoffer	358
Kochmützen	406
Koch-Schürzen	406
Kochtopf	342, 343, 348
Kofferständer	333, 439
Konditorsäge	355
Körbchen	265, 269, 298, 299 322, 323
Körbchen für Pommes frites, Früchte etc.	403
Korkenzieher	233
Kosmetik-Spiegel	437
Kosmetiktücher	434
Kreidemarker	304
Kreidetafeln	304, 307
Krüge	160, 162, 206, 207, 282
Krüge Polycarbonat	206
Krüge Porzellan	284
Krümelfentferner	300
Kuchenbleche	395
Küchenmaschine	368
Küchenmass	352, 359
Küchenmesser	355
Küchenrollen	408
Küchenschnüre	404
Küchenschüsseln	353
Küchensieb	352

Küchenspachtel	354
Küchen-Thermo-Timer	361
Küchentissue-Spender	408
Küchenwaage	389
Kugelausstecher	358
Kühlbuffet	286, 287
Kühlschrank	371, 394
Kühltisch	394
Kühlvitrine	230
Kupferbecher	216
Kupferlappen	54
Kupfer-Reinigungsmittel	52

L

Lachsmesser	355
Ladenwaage	389
Latte Macchiato-Gläser	163
Lätzchen	20
Limettenpresse	224
Longdrinkgläser/Apéro	208, 210
Löwenkopf Suppenterrine	154
Lufterfrischer	47, 50
Lunch-Tragtaschen	402

M

Maiskolben-Halter	404
Masseimer	359
Maxfry	377
Mehlbesen	56
Mehlsieb	398
Mehrzweck-Beutel	43, 58, 392
Menagen	292, 293, 296, 297
Menü-Bestellblock	338
Menü-Karten	308-310
Menükarten-Klipp	310
Menü-Papier	310
Messer	354, 355, 357, 358
Messerbänkchen	183
Messereinsatz	358
Messerhalter	358
Messerkoffer	358
Messerschärfgerät	358
Metall-Tabletts	330
Metall-Untersätze	330
Micro-Fasertuch	52
Mikrowellengerät	374
Milch-Dispenser	280, 281, 283
Milcherhitzer	283
Milchkrüge	283, 284
Mini-Einmachglas	249, 250
Mix-Becher	222, 223
Mixer	227, 364, 366
Moscow Mule	216
Mühlen	293-296
Mülleimer	43, 46, 59, 319, 442
Multifunktions-Spender	408
Multi-Therm	282, 283
Münzkästli	311, 337

Muscheltopf	150
Müsli-Dispenser	279

N

Nachfüllbeutel Hygienehalter	44
Namensschilder	336
Napperons	20
Nasswisch-/Eimer-Wagen	58
Nasswisch-Mop	57
Nestback-Löffel	351
Non-Stop-Handtücher	45, 407
Nudelmaschine	369
Numatic	58, 443, 444

O

Öl-/Essig-Ausgiesser	296
Öl-/Essig-Menagen	292, 297
Öl-Filter	377
Öl-Testgerät	377
Ofenbürste	378

P

Pacojet	365
Papierhandtücher	45, 48, 407
Papierkörbe	438, 439, 440
Paraffin-Lampenöl	313
Pariser-Löffel	358
Party-Clips	187, 251
Party-Gabel	187, 251
Party-Löffel	250, 251
Passetout	350, 361
Passier-Tücher	407
Pastamaschine	369
Pastateller	151
Pasten-Brenner	324
Pasteten-Backform	396
Pasteten-/Ramequinformen	245
Pâtisserie Ausstellplatten	402
Pâtisseriekapseln	401
Pâtisserie Kartonteller	402
Pfannen	343, 344, 348
Pfannendeckel	350
Pfeffermühlen	294, 295, 296
Picker	232
Pissoir-Einsätze	50
Pizza-Boxen	378
Pizza-Messer	186
Pizzaofen	149, 378
Pizzaschieber	378
Pizzaschneider	378
Pizzateller	151
Plakatständer	307
Plastik-Teller	36
Plattenpapiere	24
Plattenwärmer	325
Pommes Frites Körbchen	403
Portemonnaie	311, 337

P

Portemonnaie-Halfter	336
Portionenzangen	351, 352
Porzellan Accessoires	79, 89, 155, 244
	245
Porzellan Asia-Style	154, 245
Porzellan Geschirr	70, 71, 73, 75, 77
	79, 81, 83, 85, 86
Porzellan Geschirr	87, 89, 90-94, 95
	149, 150, 154, 158
Porzellan GN-Schalen	258, 259
Porzellan Löffel	187
Porzellan Piano	162
Porzellan Platten	153
Porzellan-Serien	148, 154, 245
Porzellan Spezialformen	151, 152, 153
	162, 323, 335
Porzellan Tassen	157-159
Poulet-Körbchen	403
Poulet-Manchetten	403
Poulet-Papiere	403
Präsentations-Schalen	279
Präsentierkorb	300
premiostar	33, 153, 154, 157, 158
	159, 169, 170, 174, 175
	176, 177, 187, 202, 221
	251, 325, 363, 438, 439
Prosecco- und Champagnergläser	218, 219
Putz-Eimer	57
Putzgeräte-Wagen	58

R

Raclette-Apparate	324
Radieschenschneider	354
Rahmbläser	400
Rahmbläser-Patronen	400
Ramequin-Formen	245
Rechaudkerzen	313
Rechauds	322, 324, 325, 370
Rechnungsmappe	311, 337
Regalwagen	412-415
Reinigungsmittel	53
Reisbesen	55
Reiskocher	350
Reis-Portionierer	354
Reklame-Tafel	305, 306
Reklame-Tischsteller	303
Réservé	302, 303
Riedel Gläser	194-195
Rollbehälter	420
Rosshaar-Wischer	55
Rührspaten	351
Rüstmesser	355

S

Sackkarren	421
Saft-Dispenser	267, 279, 280
Saftzentrifuge	228
Saladette	394
Salamander	374
Salatbesteck	274
Salat-/Ladenwaage	389
Salatsaucen-Töpfe	274
Salatschleuder	361
Salatschüsseln	97, 116, 124, 125
	168, 273, 279
Salzmühlen	294, 295
Salz-/Pfeffer-Menagen	292, 293
Salz- und Pfefferstreuer	293
Samowar	281
Sandwich-/Toast-Automaten	371
Santoku-Messer	355
Saucen-, Garnituren- und Gemüsebox	383
Saucenlöffel	351
Saucenpfännchen	344
Saucen-Schöpfer	184, 253, 274
Saucieren	155
Sauteuse	342-345, 356
Savarin-Form	396
Schälchen	162, 168, 244
Schälchenspender	278
Schalen	77, 79, 81, 148, 154
	168, 245
Schaufel	229
Schaumlöffel	351
Schaum-Seifenspender	47
Scheuer-Pads	53
Schieferplatten	273, 297
Schirmständer	442
Schlachtmesser	355
Schlüsselanhänger	443
Schlüsselkette	336
Schmutzwäsche-Säcke	440
Schnapslatte	246
Schneebesen	353
Schneideplatten	362, 363
Schneideplatten-Gestell	362
Schneideplatten-Hobel	363
Schneideplatten-Set	362
Schöpfbesteck	274
Schöpflöffel	256, 351
Schott-Kristallgläser	172, 188-193, 196
	198, 199, 209, 217
	219, 221
Schrubber	56, 57
Schürzen	336
Schürzenbänder	406
Schüsseln	168
Schutzbeutel für Zahnputzgläser	434
Seifenbomben	47, 49
Seifenpatronen	50, 435
Seifenspender	47, 50, 435

Seitenfalten-Beutel	403
Seltmann Porzellan	96-121, 240-243
	274, 426-428
Service-Bestellblock	338
Service-Laufbonblock	338
Servicestation	288, 289
Service-Tische	289
Service-Tücher	234
Serviergestell	278
Servierhandschuhe	407
Servierpfanne	150, 151
Servier-/Servicewagen	288, 413
Servier-System	275
Servier-Tabletts	161, 275, 326-330, 438
Servierwagen	289, 412, 413
Servietten Brunch/Snack	8
Servietten Lunch/Dinner	9
Servietten Deluxe	15
Servietten Dinnertex	16-17
Servietten Airlaid	10, 11
Servietten Deco Soft	10
Servietten für Spender	12
Servietten-Halter	12
Servietten Papier	12
Serviettenringe	33
Servietten Soft	10, 11
Servietten-Spender	12
Serviettentaschen	33
Servietten Textil	33
Servietten Tissue	12
Servitray	332
Shampoo	435
Shot Glas	246
Shun Damastmesser	357
Silberpolierschaum	52
Silikon-Backform	398
Soda Siphon Kisag	223
SPA-Collection	432, 433, 434
Spargelschäler	358
Sparschäler	354
Spätzli-Sieb	350
Speiseausgabewagen	381
Spender für WC-Rollen Jumbo	42
Spiegelau Kristallgläser	196
Spinnwebenspray	53
Spiral-Knetmaschine	368
Spiral-Stahlschwamm	54
Spitzenpapiere	25
Spitzsieb	352
Stab-Feuerzeug	313
Stabmixer	364
Standascher/Abfallbehälter	319, 442
Stapel-Behälter	420
Stapelglas	210
Staubsauger HENRY plus	58, 443
Staubschutz-Deckel	417, 418
Staubwedel	55
Steak-Messer	186
Steelite Porzellan	68-95
Stielbürsten	56

Inhalt A - Z

S			
Streuer	293	Tischläufer Soft	21
Suppenkessel	256	Tisch-Leuchten	316
Suppenrechaud	370	Tischmoltons	32
Systemteller	92, 426-428	Tischnummern	302
		Tischset	18, 32
		Tischset Fleck-weg	32
		Tisch-Sets Soft	18
		Tisch-Sets Tissue	18
		Tischsteller	302, 303, 304
		Titan-Bratpfannen	349
		Toaster	371
		Toiletten-Abfallboy	43, 49, 440
		Toiletten-Papier	40, 41, 42
		Tomatenmesser	355
		Top Fresh	276
		Tortengitter	398
		Tortenglocken	300
		Tortenheber	401
		Tortenring	396
		Tortenschnitten-Papier	402
		Tortenteiler	398
		Tourniermesser	355
		Tranchierbesteck	355
		Tranchierplatten	362, 363
		Transportbehälter	423
		Transportkörbe	420
		Transportwagen	421
		Tretmülleimer	43
		Trichter	352
		Trinkhalme	216, 231
		Trinkhalm-Löffeli	232
		Tumbler	211
		Tür-Anhängeschilder	440
T		U	
Tablett-/Kofferständer	333	Überlauf-Bürsten	54
Tablett-Papiere	24	Universal-Schöpflöffel	351
Tabletts	146, 264, 265, 275		
Tabletts	326, 327, 328, 330		
Tabletts mit Werbedruck	326, 328		
Tafelständer	306		
Take away-Becher	30, 31, 35-37		
Take away-Boxen	33		
Tassen-Unterlagen	22		
Tassen-Unterlagen bedruckt	22, 23, 331		
Tasse Piano	157		
Teebecher	162		
Teebeutel-/Konfischälchen	162, 168		
Teebeutel-Untersatz	27		
Tee-Glas	162, 163, 166, 170 207, 216, 217, 247 250, 280		
Teelichter	313-317		
Tee-Set	160, 162		
Teesieb	160		
Teigrädchen	378, 397		
Teigschaber	396, 397		
Teigwaller	396		
Teigwaren-Einsätze	345, 369		
Tellerhauben	381		
Tellerkörbe	416		
Tellerpapiere	22		
Teller Piano	162		
Tellerservietten	22		
Tellerspender	381		
Tellerstapler	392, 393		
Tellerstapler-Wagen	393		
Tellerwärmer	257		
Terrineform	396		
Testo Frittieröl-Tester	377		
Thermoboxen	276		
Thermobox Pizza	378		
Thermometer	361		
Thermo-Servierhandschuche	407		
Thermos-Pumpkanne	281		
Thermo-Whip	400		
Tiefkühlschrank	394		
Tischabfall-Becher	317		
Tischdecken Fleck-weg	32		
Tischdecken Papier	20		
Tischdecken Silk	20		
Tischdecken Soft	20		
Tischdecken Textil	20, 32, 33		
Tischdeckrollen	21		
Tisch-Dosenöffner	356		
Tischhalter für Weinkühler	236		
		V	
		Vacu-Vin-Pumpe	233
		Vakuumbbeutel	391
		Vakuumb-Verpackungsmaschine	390
		Valera Haartrockner	436
		Vasen	317
		Vermicelles-Presse	400
		Vitrine	230
		Vorratstonnen	421
		Vorratswagen	421
		W	
		Waagen	389
		Wämeschränke	257
		Wand Aschenbecher	319
		Wand-Haftmagnete	339
		Wandhalter	225
		Wandhalterung für Tellerstapler	392
		Wandpreistafel	337
		Wandschienen	271
		Wandwickeltisch	334
		Wärmebrücken	379
		Wärmebuffet	287
		Wärme Kies	252
		Wärmelampe	379
		Wärme-Strahler	379
		Warmhaltegerät	375
		Warmhalteplatten	325
		Wäschebeutel	444
		Wäschewagen	443, 444
		Wassergläser	208-211, 214, 215 217, 220
		Wasserkocher	438
		Wasser-Schieber	57
		WC-Besen-Garnituren	42
		WC-Ersatzrollenhalter	42
		WC Fresh-Reiniger	51
		WC-Papier	40, 41, 42
		WC-Rollendispenser	49
		WC-Rollenhalter	40, 42
		Weck Gläser	249, 250
		Wein-Dekanter	203
		Wein-Karaffen	202, 204, 205
		Weinkarte	311
		Wein-Kelche	188-193, 196, 198-201 209-211, 217, 218, 246
		Weinkühler	234, 235, 236
		Weinkühlständer	235, 236
		Whiskygläser	208, 220, 221
		Whisky-Massbecher	224
		Wickeltisch	334
		Wind-Aschenbecher	319
		Windlichter	313-317
		Windowmarker	304
		Wok	343
		Wrapmaster-System	405
		Z	
		Zahnstocher	232
		Zeigetaschen	310
		Zeitungshalter	311, 339
		Zeitungsb-Wandhalter	311
		Zentrifuge	228
		Zitronenpresse	164
		Zitruspresse	226, 228
		Zuckerbehälter	164
		Zuckerdosierer	296
		Zuckerstreuer	353, 399
		Zwiesel	188-193, 198, 199 209, 211, 217

Gastroimpuls

Hunkeler Gastro AG
A-Z für die Gastronomie
CH-6002 Luzern

T 041 368 91 91

F 041 368 91 90

info@gastroimpuls.ch

www.gastroimpuls.ch

Ausstellung

Öffnungszeiten

Montag – Freitag

08.00 – 12.00 Uhr

13.30 – 17.00 Uhr

Wir freuen uns auf Ihre
Anmeldung

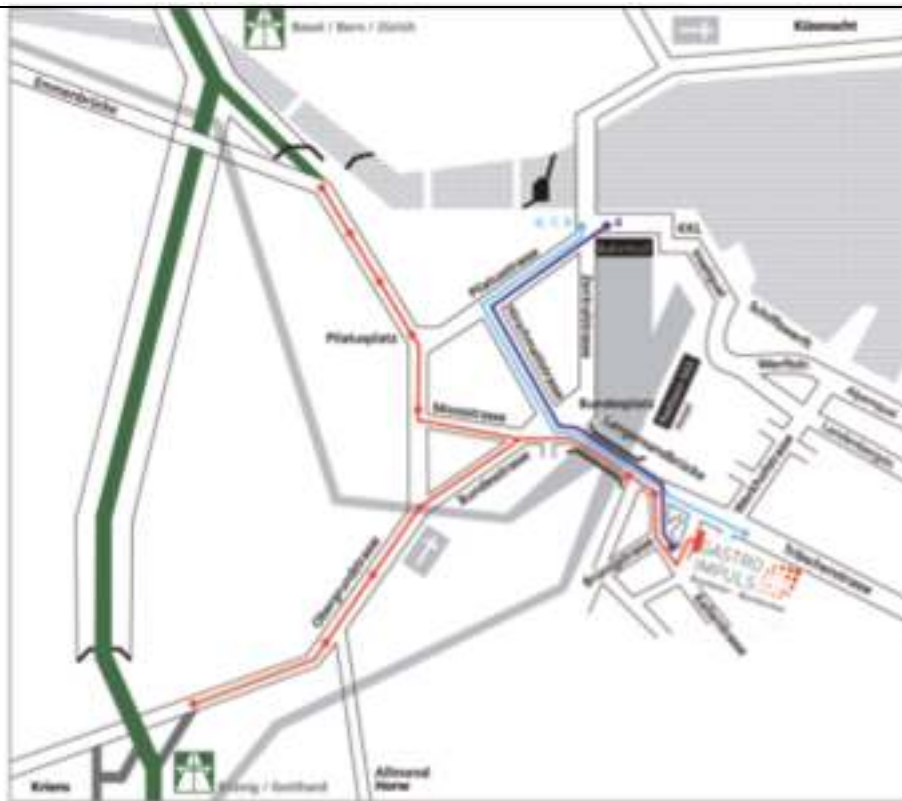

Anreise

Autobahn Luzern City / Süd

• Lichtsignale

■ Bus Linie 4
Station Brünigstrasse

■ Bus Linien 6, 7, 8
Station Werkhofstrasse



www.gastroimpuls.ch

Einfach und bequem einkaufen
7 Tage - 24 Stunden



Ausstellung ZAGG Luzern
21. - 24. Oktober 2018

Gastroimpuls - Hunkeler Gastro AG

Stand 233
Halle 2

Allgemeine Geschäftsbedingungen der Hunkeler Gastro AG

Mit der Auftragserteilung anerkennt der Besteller die nachstehend aufgeführten Konditionen. Alle Katalog- und Onlineangaben sind frei-bleibend und können ohne vorherige Bekanntgabe geändert werden. Bei Bestellungen sind die Verpackungseinheiten einzuhalten.

Preis

Es gelten Tagespreise in CHF, exkl. MWST. Bestellungen mit infolge Hausse oder Baisse überholten Preisangaben aus dem Katalog werden ohne Rückfrage zu den gültigen Preisen ausgeliefert. Offerten sind nur für die angefragte Gesamtbestellung und bei sofortiger Zusage gültig.

Lieferfrist

Wir versuchen die uns von Lieferanten bestätigten und kommunizierten Fristen einzuhalten. Lieferverzögerungen ermächtigen den Käufer nicht vom Kaufvertrag zurückzutreten oder Ansprüche zu stellen.

Lieferung

Liefermöglichkeit, Irrtum sowie Zwischenverkauf müssen wir uns vorbehalten. Alle Sendungen (auch portofreie) werden auf Risiko und Gefahr des Empfängers geliefert. Verpackungsmaterial wird nicht zurückgenommen.

In der Schweiz und in Liechtenstein: Auf dem günstigsten Transportweg per Cargo Domizil/DPD oder Post. Franko Empfänger oder Talbahnstation ab CHF 600.00. Kostenanteil pro Paket/Palett bei Warenwert unter CHF 600.00: bis 10 kg CHF 10.00; bis 20 kg CHF 14.00; bis 31 kg CHF 16.00; Frachtsendungen/Anlieferung Bordsteinkante CHF 60.00.

Terminlieferungen, Expresszuschläge und/oder Avisierungen kosten extra und gehen zu Lasten des Bestellers/Empfängers.

Ausland: Mindestbestellwert CHF 300.00. Die Lieferung der Ware erfolgt (ab Laderampe Luzern) auf Kosten und Gefahr des Kunden.

Zahlung

Innert 30 Tagen rein netto. Unberechtigte Abzüge werden in jedem Fall nachgefordert. Lieferungen ins Ausland erfolgen gegen Vorauszahlung oder gegen Dokumente. Andere Regelungen gegen schriftliche Abmachung.

Bei Neukunden oder Eröffnung neuer Betriebe wird eine Zahlung von $\frac{2}{3}$ der gesamten Auftragssumme mit der Auftragsbestätigung eingefordert und die Restsumme innert 30 Tagen nach Rechnungsdatum vereinbart. Wir akzeptieren folgende Kreditkarten: Mastercard, Visa, Maestro und Postcard.

Muster

Muster werden inklusive Versandkosten verrechnet. Werden Muster innerhalb von 6 Wochen ohne Rückmeldung auf Verlängerung nicht retourniert, wird der Rechnungsbetrag eingefordert.

Beanstandung

Müssen spätestens innert 8 Tagen nach Erhalt der Ware schriftlich gemeldet sein. Reklamationen über Beschädigungen oder fehlende Ware müssen sofort in Anwesenheit des Überbringers auf dem Lieferschein angebracht werden.

Rücksendung

Neuwertige Lagerware in Originalverpackung kann, nur nach vorgängiger Vereinbarung mit Hunkeler Gastro AG, zurückgesandt werden. Bei der Gutschrift werden unser Versandkostenanteil, eine Bearbeitungsgebühr und eine allfällige Preisdifferenz abgezogen. Sonderbestellungen aller Art werden nicht zurückgenommen.

Garantie für Apparate

Der Anspruch des Käufers oder sein Rechtsnachfolger besteht auf kostenlose Nachbesserung, wenn er während der vereinbarten Garantiezeit den Mangel anzeigt. Die Garantiezeit beträgt 12 Monate ab Erhalt der Lieferung. Die Garantiezeit für ersetzte Teile beträgt 12 Monate ab deren Ersatz. Weitergehende Ansprüche des Käufers, insbesondere auf Schadensersatz statt der Leistung und auf Ersatz eines sonstigen unmittelbaren oder mittelbaren Mangelschadens einschliesslich Begleit- oder Folgeschadens sowie auf Aufwendungsersatz, auch aus Verschulden bei Vertragsabschluss oder unerlaubter Handlung, sind ausgeschlossen. Schadenersatzansprüche zufolge entgangenen Gewinns, Mangel-folgeschäden, etc. werden ausdrücklich wegbedungen.

Eigentumsvorbehalt

Die gelieferte Ware bleibt bis zur vollständigen Bezahlung unser Eigentum. Auf unseren Wunsch kann der Eigentumsvorbehalt eingetragen werden. Unbezahlte Waren dürfen weder verpfändet noch zur Sicherheit an Dritte übergeben werden.

Gerichtsstand

Ist in jedem Fall und für beide Parteien Luzern.

COPYRIGHT by Hunkeler Gastro AG, Luzern.
Alle Rechte vorbehalten. Auch auszugsweiser Ausdruck nicht gestattet.

Conditions générales de vente de Hunkeler Gastro AG

Lors de sa commande, le donneur d'ordre reconnaît les conditions de vente et de livraison énoncées ci-après. Les informations contenues dans le catalogue et sur le site sont non-contractuelles et sujettes à des modifications sans préavis. Les commandes doivent respecter les unités d'emballage.

Prix

Seront valables les prix du jour de la livraison, tous les prix communiqués sont en FRS., sans TVA. Sous réserve de modifications et d'erreurs ainsi que de changements de prix à conséquence d'une hausse ou d'une baisse la marchandise est livrée sans requête. Les offres sont valables que sur le montant total ainsi qu'une réponse immédiate.

Délais de livraison

Nous nous efforçons de respecter les délais de livraison indiqués dans les confirmations de commande. Aucun retard de livraison ni défaut de livraison autorise l'acheteur de résilier le contrat d'achat.

Livraison

Nous sommes contraints de nous réserver les possibilités de livraison, les erreurs et la vente. La marchandise est expédiée au risque et péril du destinataire (aussi pour les livraisons franco). Le matériel d'emballage n'est pas repris.

En Suisse et au Liechtenstein: l'option de transport c'est la plus avantageuse par Cargo Domicile/DPD ou par poste. Franco destinataire ou gare en pleine à partir de FRS 600.00. Part du coût par paquet/palette pour envoi en dessous de FRS 600.00 : jusqu'à 10 kg FRS 10.00; jusqu'à 20 kg FRS 14.00; jusqu'à 31 kg FRS 16.00; livraisons de fret/franco domicile FRS 60.00.

Les livraisons à des heures fixes et/ou les avis, livraison express sont en sus et à la charge de l'acheteur/du destinataire.

Livraison à l'étranger: le montant minimum de l'achat est fixé à FRS 300.00. La marchandise voyage pour le compte, aux risques et aux couts de l'acheteur (depuis la rampe de chargement à Lucerne).

Paiement

30 jours net. Des rabais injustifiés seront réclamés. Les livraisons à l'étranger sont effectuées uniquement contre paiement préalable. Tout accord divergent est valable seulement s'il a été convenu par écrit. Nouveaux clients ou ouvertures d'entreprise, il faut virer sur le compte de Hunkeler Gastro SA $\frac{2}{3}$ du montant total à la confirmation de la commande. La somme restante au plus tard dans les 30 jours à compter de la date de la facture. Nous acceptons les cartes de crédit suivantes: Mastercard, Visa, Maestro et Postcard.

Echantillons

Ces sont facturées inclus frais d'expédition. Si les échantillons ne sont pas retournés dans un délai de maximum 6 semaines, le montant de cette facture est à régler immédiatement.

Réclamations

Doivent être faites par écrit immédiatement après réception de la marchandise, au plus tard dans les 8 jours. Les réclamations pour les dommages ou la marchandise manquante doivent être effectuées immédiatement sur le bulletin de livraison en présence du livreur.

Retour de marchandise

La reprise d'articles du stock non utilisés et encore dans leur emballage d'origine n'est possible qu'après entente avec Hunkeler Gastro SA préalable. Les frais de transport et la différence de prix de la quantité gardée seront déduits de la note de crédit. Commandes spéciales ne seront pas reprises.

Garantie relative aux appareils

Les règles de garantie prévues par la loi en matière de défauts matériels et de vices juridiques sont exclues. A la place les règles suivantes s'appliquent: l'acheteur et son cessionnaire légale ont le droit donné d'une réparation gratuite s'il signale le vice survenu durant la période de garantie couverte. Le délai de garantie est de 12 mois à partir de la réception. Un nouveau délai de garantie de 12 mois est applicable aux éléments remplacés ou réparés il court dès le remplacement. Nous déclinons toute responsabilité pour tous autres dommages directs ou indirects des dommages. Tout droit à des dédommagements à la suite d'un manque à gagner, de dommages consécutifs aux vices, etc. est expressément exclue.

Réserve de propriété

Les articles livrés restent notre propriété jusqu'au moment du paiement intégral. Cette clause peut être activée à notre demande. Avant paiement complet, les marchandises ne peuvent ni n'être engagées au profit de tiers, ni transférées, ni cédées.

Lieu de juridiction

Lieu d'exécution et de juridiction pour les deux parties: Lucerne.

COPYRIGHT by Hunkeler Gastro SA, Lucerne.
Tous les droits sont réservés. Même une impression par extraits n'est pas permise.

GASTRO IMPULS

Hunkeler Gastro AG

**20 %
RABATT**



Moscow Mule Kupfer Mug

CNS/Kupfer, gehämmert, 500 ml,
90 mm, H: 95 mm, Art. Nr. 161 09 55. Seite 216

Zum Vorzugspreis CHF 16.00

exkl. MwSt. statt CHF 20.00

Gastroimpuls

Hunkeler Gastro AG
Grimselweg 5
6002 Luzern
Telefon 041 368 91 91
www.gastroimpuls.ch



**SWISS
CULINARY
NATIONAL
TEAM**

HOTEL & GASTRO
union | **skv**
SEIT 1884 | SCHWEIZER KOCHVERBAND